

# ENVIRONMENTAL PRODUCT DECLARATION

as per ISO 14025 and EN 15804+A2

Owner of the Declaration	Hilti Aktiengesellschaft
Publisher	Institut Bauen und Umwelt e.V. (IBU)
Programme holder	Institut Bauen und Umwelt e.V. (IBU)
Declaration number	EPD-HIL-20230211-IBC1-EN
Issue date	01/09/2023
Valid to	31/08/2028

## MT- System (Outdoor) HILTI AG

[www.ibu-epd.com](http://www.ibu-epd.com) | <https://epd-online.com>



ECO PLATFORM

**EPD**  
VERIFIED

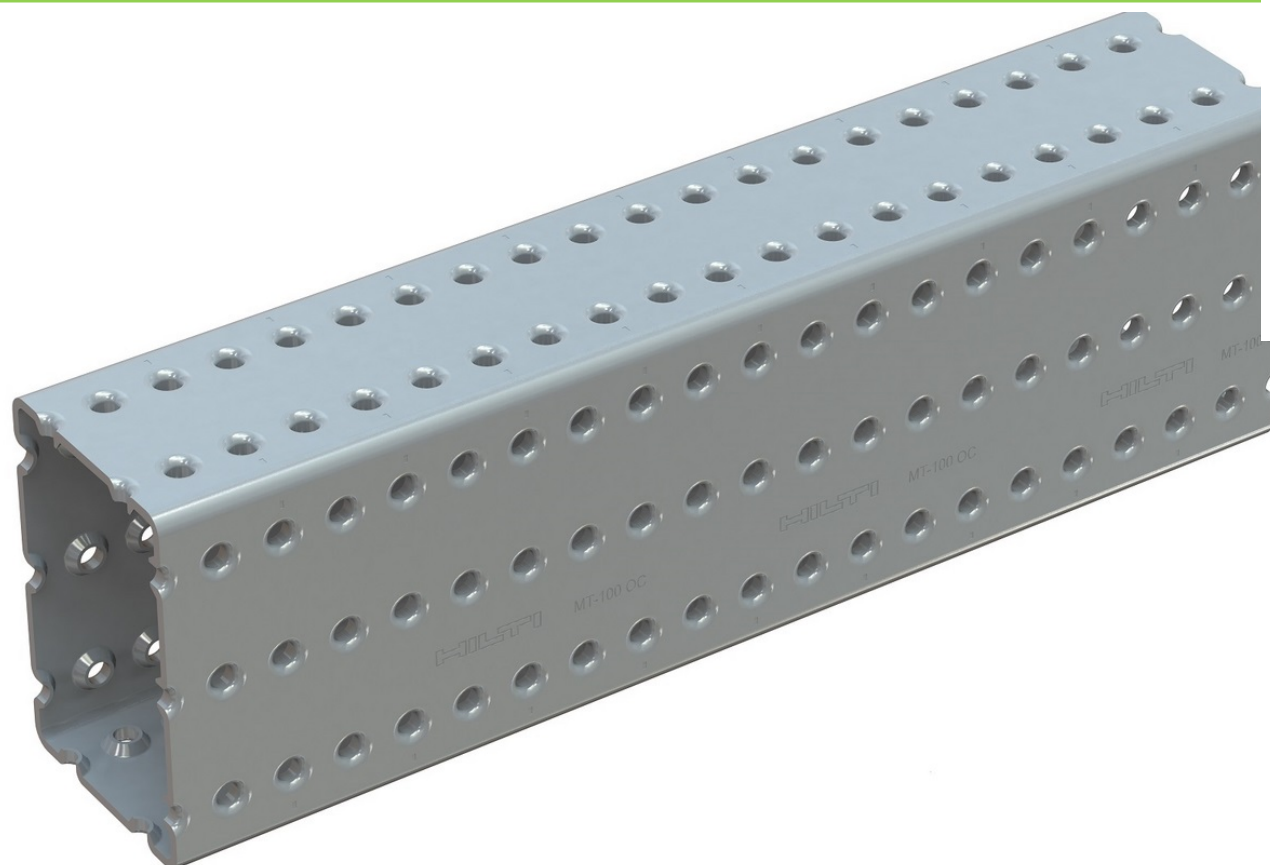

## 1. General Information

### HILTI AG

**Programme holder**

IBU – Institut Bauen und Umwelt e.V.  
Hegelplatz 1  
10117 Berlin  
Germany

**Declaration number**

EPD-HIL-20230211-IBC1-EN

**This declaration is based on the product category rules:**

Connection, assembly and installation systems, 01/08/2021  
(PCR checked and approved by the SVR)

**Issue date**

01/09/2023

**Valid to**

31/08/2028

Dipl.-Ing. Hans Peters  
(Chairman of Institut Bauen und Umwelt e.V.)

Florian Pronold  
(Managing Director Institut Bauen und Umwelt e.V.)

### MT- System (Outdoor)

**Owner of the declaration**

Hilti Aktiengesellschaft  
Feldkircher Strasse 100  
9494 Schaan  
Liechtenstein

**Declared product / declared unit**

Name of declared product / declared unit

**Scope:**

This document relates to the I.-Girder MT-100 OC ("MT-100 OC") as a representative product for the MT Outdoor profile portfolio. The MT Outdoor profile portfolio is a set of installation channels and girders with 6 types of wall thickness –1.5mm, 1.75mm, 2mm, 2.75mm, 3mm and 4mm. Then the products are distinguished into size classes by shape and load performance. Each of these size classes are produced in 2 different lengths to accommodate intended use, which are 2 meters, 3 meters and 6 meters. The declared product for this EPD is MT-100 OC, with thickness of 4mm, because it is the worst case scenario within the MT Outdoor profile portfolio.

The owner of the declaration shall be liable for the underlying information and evidence; the IBU shall not be liable with respect to manufacturer information, life cycle assessment data and evidences.

The EPD was created according to the specifications of EN 15804+A2. In the following, the standard will be simplified as *EN 15804*.

**Verification**

The standard EN 15804 serves as the core PCR			
Independent verification of the declaration and data according to ISO 14025:2011			
<input type="checkbox"/>	internally	<input checked="" type="checkbox"/>	externally

Mrs Kim Allbury,  
(Independent verifier)

## 2. Product

### 2.1 Product description/Product definition

The MT-100 OC is designed as a metallic substructure system that is made of thin-walled steel in a rectangular shape with surface coating for the outdoor environment. All 4 sides of the profile with connection holes interfaces with other assembly components to form a flexible modular support substructure that is fastened to concrete or steel frame structures. They are horizontal and vertical members at different lengths that interconnect to form either 2D or 3D structures to carry the weight and hold in place mechanical, electrical, and piping services. For the placing of the product on the market in the European Union European Free Trade Association/ EU/EFTA (with the exception of Switzerland) *Regulation (EU) No. 305/2011 (CPR)* applies. The product needs a declaration of performance taking into consideration the following European Technical Approval *ETA-21/0414* assessed based on *EAD 280016-00-0602* 'Products for installation systems for supporting technical building equipment' and the CE-marking. For the application and use the respective national provisions apply.

The individual channel items under this product family are as listed below:

Image	Designation
<b>PROFILES - threaded rod trapeze</b>	
	<b>MT-15 OC</b>
	<b>MT-20 OC</b>
	<b>MT-40 T OC</b>
	<b>MT-40 T S OC</b>

Image	Designation
<b>PROFILES - strut / open C-Channels</b>	
	<b>MT-30 OC</b>
	<b>MT-30 S OC</b>
	<b>MT-40 OC</b>
	<b>MT-40 S OC</b>
	<b>MT-50 OC</b>
	<b>MT-50 S OC</b>
	<b>MT-60 OC</b>
	<b>MT-60 S OC</b>

Image	Designation
<b>PROFILES - double strut / open C-Channels</b>	
	<b>MT-40D OC</b>
	<b>MT-40D S OC</b>

Image	Designation
<b>PROFILES - closed profiles / box girders</b>	
	<b>MT-70 OC</b>
	<b>MT-70 S OC</b>
	<b>MT-80 OC</b>
	<b>MT-80 S OC</b>
	<b>MT-90 OC</b>
	<b>MT-90 S OC</b>
	<b>MT-100 OC</b>
	<b>MT-100 S OC</b>

## 2.2 Application

The MT-100 OC is developed to be fixed on base materials like concrete and steel frame structure to support the mechanical, electrical, and piping services so that their loads are transferred to the super structure of the building or facility. The product is intended to be used under outdoor conditions for supporting:

- Pipes for the transport of fluids and gas
- Technical building equipment in general
- Components of fixed fire-fighting systems
- Electrical cable layouts
- Ventilating system layouts and equipment
- Flooring
- Other instrumentation

## 2.3 Technical Data

The following data complies to the dimension drawing provided in the Annexe A3 of *ETA-21/0414*.

### Constructional data

Name	Value	Unit
Thickness of material	4	mm
Height of profile	150	mm
Width of profile	100	mm
Length of profile	6000	mm

Performance data of the product in accordance with the declaration of performance with respect to its essential characteristics according to *ETA-21/0414* assessed based on *EAD 280016-00-0602* 'Products for installation systems for supporting technical building equipment'.

## 2.4 Delivery status

The MT-100 OC is packaged in bundles of long goods, and each length types are bundled together with steel straps then protected at the edges with wooden blocks. The declared MT-100 OC is delivered in 20 pieces of 6 meter lengths, constituting a bundle of total 120 meters.

## 2.5 Base materials/Ancillary materials

Name	Value	Unit
Continuously hot-dip zinc-magnesium alloy coated steel	100	%

The raw material used to produce the declared product MT-100 OC is galvanized steel according to the standard *EN 10346:2015*, weighing 15.096 kg per meter.

This product/article/at least one partial article contains substances listed in the *REACH SVHC* candidate list (date: 17.01.2023) exceeding 0.1 percentage by mass: NO.

This product/article/at least one partial article contains other CMR substances in categories 1A or 1B which are not on *the candidate list*, exceeding 0.1 percentage by mass: NO.

Biocide products were added to this construction product or it has been treated with biocide products (this then concerns a treated product as defined by the (EU) *Ordinance on Biocide Products No. 528/2012*): NO.

## 2.6 Manufacture

The raw material for MT-100 OC is sourced from Bremen, Germany and transported to Gresten, Austria via train. The profile is manufactured through a cold-roll forming process of steel sheets which also includes cutting to designated lengths at the end of the line.

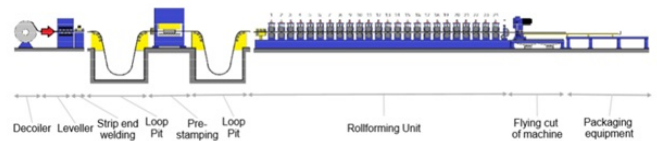

## 2.7 Environment and health during manufacturing

Hilti ensures that the suppliers implement a quality management system that meets the requirements of the *ISO 9001* or *ISO/TS 16949* standards or higher. Quality must be planned, ensured and documented using appropriate quality tools, e.g. Statistical process control (SPC) or failure, mode and effects analysis (FMEA). The production and quality control according to the product specifications and approval specifications of the MT profile and its system components are ensured by an in-house quality control by Hilti.

We expect the environmental management implemented by our suppliers to meet at least the *ISO14001* standard international regulations on forbidden substances.

The supplier for the MT-100 OC holds the following certifications:

- *ISO 9001*
- *ISO 45001*
- *ISO 14001*

## 2.8 Product processing/Installation

The MT-100 OC is supplied as a ready to install modular support system element provided with an Instruction for Use explaining the basic steps for installation.

The MT-100 OC is either connected to a pre-positioned baseplate element that connects it to the building structure or is positioned directly to the building structure when delivered as a pre-assembled module. For fastening the connection point to the baseplate or other connection elements, a Hilti automated impact wrench tool called SIW 6AT-A22 may be used to ensure anchoring or bolting at precise fastening torques. No special environmental protection measures need to be taken while

installing the MT profiles.

### 2.9 Packaging

The MT-100 OC is delivered packed and strapped in bundles as long goods. The product type can be either in 3 meter lengths or 6 meter lengths. Same length types are bundled together in steel straps and delivered on wooden blocks that protect the ends of the bundles. Depending on the usage case and user request, the profile can be cut into various lengths as requested and bundled or preassembled in customized conditions.

Both the wooden blocks and steel straps cannot be re-used but can be recycled.

### 2.10 Condition of use

All supplied materials are protected in the installed condition against external influences and designed for the service life of the respective construction.

### 2.11 Environment and health during use

When used as designated, there is no impact on the environment or health.

### 2.12 Reference service life

The MT-100 OC has an assumed service life of 50 years in accordance with the *BBSR* table 'Service lives of Components for life cycle assessment according to BNB'. The practical service life can however be considerably longer and will depend on the specific installation situation and the product exposure scenario. The main factors influencing the period of use involve weathering as well as mechanical loads.

### 2.13 Extraordinary effects

#### Fire

The MT-100 OC is assessed in accordance with the European Assessment Document *EAD 280016-00-0602* for the following performance in safety in case of fire (BWR2).

#### Fire protection

Name	Value
Reaction to fire	Class A1
Pull-through resistance of channel back holes under fire exposure	ETA 23/0105
Bending characteristics under fire exposure	ETA 23/0105

## 3. LCA: Calculation rules

### 3.1 Declared Unit

The declared product here is a mounting system from HILTI AG with the designation I.-Girder MT-100 OC as a representative product from the MT Outdoor portfolio. The declared unit refers to 1 kg of mounting system. The packaging, related to 1 kg of mounting rail, is additionally included in the calculation with 0.007 kg. The following table shows the data of the declared unit.

#### Declared unit and mass reference

Name	Value	Unit
Declared unit	1	kg
Gross density	7850	kg/m <sup>3</sup>
Mass reference	14,8	kg/m
conversion factor	14,8	

### 3.2 System boundary

Type of EPD: Cradle to factory gate with options. The following information modules are defined as system boundaries in this study:

#### Water

The MT-100 OC is comprised of continuous hot-dip coated steel. There are no environmental risks attributable to the effects of water except the product's own corrosion impact.

#### Mechanical destruction

In the event of mechanical destruction of the MT-100 OC, the profile assembly has to be replaced with a new set for the intended functional performance.

#### 2.14 Re-use phase

The MT-100 OC cannot be re-used as a component for a modular support system, but the material can be recycled. All components of the described product can be returned and recycled into the material cycle.

#### 2.15 Disposal

The MT-100 OC is disassembled from a building in which it has been installed by a series of unfastening processes. The interfaces with assembly components and with concrete or steel structures which have been originally fastened with a bolt and nut mechanism are untightened and separated back into individual product parts without change or deformation of the product material. These are fed into the recycling process in accordance with the applicable disposal guidelines. The waste code for the profiles in accordance with the *European Waste Index is 17 04 05* (iron and steel).

#### 2.16 Further information

Further information is available on the Hilti website:

[www.hilti.group](http://www.hilti.group)

#### Production stage (A1- A3):

- A1, raw material extraction,
- A2, transport to the manufacturer,
- A3, production.

#### End of life (C1- C4):

- C1, deconstruction/demolition,
- C2, transport,
- C3, waste treatment ,
- C4, disposal.

Reuse, recovery and recycling potential (D).

In order to accurately capture the indicators and environmental impacts of the declared unit, a total of 8 information modules are considered. The information modules A1 to A3 describe the material provision, the transport to the production site, as well

as the production processes of the product itself.

The primary products are sourced from the European Union. The transport is carried out by lorry and train. The following flow charts illustrate the underlying production process.

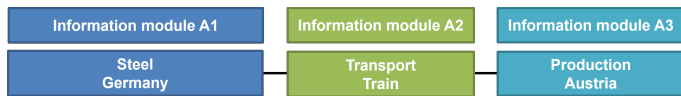

Illustration 1: Information modules A1 to A3 of product

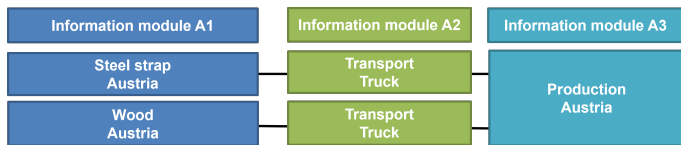

Illustration 2: Information modules A1 to A3 of packaging

In the information modules C1 to C4, the deconstruction or demolition from the building, the transport to waste disposal, the waste treatment and disposal of the product are recorded. Furthermore, reuse, recovery and recycling potentials are reported in information module D.

### 3.3 Estimates and assumptions

A steel coil with zinc content was used for the I.-Grider MT-100 OC. The transport of the lubricant was not taken into account, as themass fraction is small and the effect is estimated to be low

### 3.4 Cut-off criteria

The transport for the lubricant was not taken into account as the mass fraction is small. The lubricant itself was taken into account in the production for transparency of production. The cut-off criterion according to EN 15804+A2 is otherwise not applied. All energy and mass inputs were taken into account.

### 3.5 Background data

The background data referred to in this study comes from *Sphera's LCA for Experts database*.

### 3.6 Data quality

For the preparation of the LCA, specific data from the Gersten plant in Austria of HILTI AG from the year 2022 were collected. The background data from the *LCA for Experts database* is from 2023 and therefore highly relevant. The data quality is rated as adequate.

### 3.7 Period under review

The input and output flows used in this calculation come from the annual average consumption from the year 2022.

### 3.8 Geographic Representativeness

Land or region, in which the declared product system is manufactured, used or handled at the end of the product's lifespan: Global

### 3.9 Allocation

The assembly system I.-Girder MT-100 OC as a representative product of the MT Outdoor portfolio is produced in Gresten in Austria. The data for input and output flows are taken from the year 2022, which corresponds to the annual average. The input and output flows used in this calculation were measured directly by the manufacturer for this production process and are shown in the following table. To calculate the net flows, the mass that is generated as production waste in the production process and is used as external steel scrap is subtracted from the total mass of secondary material.

### 3.10 Comparability

Basically, a comparison or an evaluation of EPD data is only possible if all the data sets to be compared were created according to *EN 15804* and the building context, respectively the product-specific characteristics of performance, are taken into account. The database referred to in this study is *LCA for Experts by Sphera*.

## 4. LCA: Scenarios and additional technical information

### Characteristic product properties of biogenic carbon

The declared product does not contain any biogenic Carbon.

### Information on describing the biogenic Carbon Content at factory gate

Name	Value	Unit
Biogenic carbon content in accompanying packaging	0.0018	kg C

### End of life (C1-C4)

In information module C1, the demolition of the mounting system from the building is calculated. The demolition is carried out with an electric screwdriver. The electrical energy consumption for the tool is assumed to be 0.003 MJ for the

specified unit. The electricity consumption is calculated with a German electricity mix.

In information module C3, the waste treatment (sorting and pressing) of the steel is calculated. med to be 0.003MJ for the declared unit. The electricity consumption is calculated with a German electricity mix

Name	Value	Unit
Collected separately waste type	1	kg
Recycling	1	kg

### Reuse, recovery and/or recycling potentials (D), relevant scenario information

In Module D, a recycling rate of 85% is assumed (world steel association).

Name	Value	Unit
Recycling	0,85	kg

## 5. LCA: Results

DESCRIPTION OF THE SYSTEM BOUNDARY (X = INCLUDED IN LCA; ND = MODULE OR INDICATOR NOT DECLARED; MNR = MODULE NOT RELEVANT)

Product stage			Construction process stage		Use stage							End of life stage				Benefits and loads beyond the system boundaries
Raw material supply	Transport	Manufacturing	Transport from the gate to the site	Assembly	Use	Maintenance	Repair	Replacement	Refurbishment	Operational energy use	Operational water use	De-construction demolition	Transport	Waste processing	Disposal	Reuse-Recovery-Recycling-potential
A1	A2	A3	A4	A5	B1	B2	B3	B4	B5	B6	B7	C1	C2	C3	C4	D
X	X	X	MND	MND	MND	MND	MNR	MNR	MNR	MND	MND	X	X	X	X	X

RESULTS OF THE LCA - ENVIRONMENTAL IMPACT according to EN 15804+A2: 1 kg I.Girder MT-100 OC

Parameter	Unit	A1-A3	C1	C2	C3	C4	D
Global Warming Potential total (GWP-total)	kg CO <sub>2</sub> eq	2.85E+00	7.28E-04	4.42E-03	1.69E-02	0	-1.89E+00
Global Warming Potential fossil fuels (GWP-fossil)	kg CO <sub>2</sub> eq	2.85E+00	7.28E-04	4.39E-03	1.69E-02	0	-1.89E+00
Global Warming Potential biogenic (GWP-biogenic)	kg CO <sub>2</sub> eq	2.92E-03	1.58E-07	0	4.11E-06	0	-1.02E-03
Global Warming Potential luluc (GWP-luluc)	kg CO <sub>2</sub> eq	1.32E-03	1.06E-07	2.61E-05	2.12E-06	0	-6.72E-04
Depletion potential of the stratospheric ozone layer (ODP)	kg CFC11 eq	2.14E-12	4.29E-17	7.63E-16	1.58E-10	0	-1.42E-12
Acidification potential of land and water (AP)	mol H <sup>+</sup> eq	6.56E-03	8.57E-07	1.69E-05	9.99E-05	0	-4.14E-03
Eutrophication potential aquatic freshwater (EP-freshwater)	kg P eq	2.84E-06	7.24E-11	1.02E-08	3.05E-07	0	-1.44E-06
Eutrophication potential aquatic marine (EP-marine)	kg N eq	1.65E-03	2.85E-07	8.07E-06	4.53E-05	0	-1.06E-03
Eutrophication potential terrestrial (EP-terrestrial)	mol N eq	1.8E-02	3.1E-06	9.02E-05	4.92E-04	0	-1.14E-02
Formation potential of tropospheric ozone photochemical oxidants (POCP)	kg NMVOC eq	5.49E-03	7.87E-07	1.53E-05	1.45E-04	0	-3.5E-03
Abiotic depletion potential for non fossil resources (ADPE)	kg Sb eq	1.14E-07	3.01E-12	3.09E-10	3.49E-09	0	-7.25E-08
Abiotic depletion potential for fossil resources (ADPF)	MJ	3.78E+01	1.07E-02	5.92E-02	2.29E-01	0	-1.68E+01
Water use (WDP)	m <sup>3</sup> world eq deprived	3.42E-02	4.08E-06	2.27E-05	4.76E-04	0	-2.2E-02

RESULTS OF THE LCA - INDICATORS TO DESCRIBE RESOURCE USE according to EN 15804+A2: 1 kg I.Girder MT-100 OC

Parameter	Unit	A1-A3	C1	C2	C3	C4	D
Renewable primary energy as energy carrier (PERE)	MJ	1.55E+00	4.08E-05	3.83E-03	1.12E-03	0	-9.97E-01
Renewable primary energy resources as material utilization (PERM)	MJ	8E-02	0	0	0	0	0
Total use of renewable primary energy resources (PERT)	MJ	1.63E+00	4.08E-05	3.83E-03	1.12E-03	0	-9.97E-01
Non renewable primary energy as energy carrier (PENRE)	MJ	3.81E+01	1.07E-02	5.92E-02	2.29E-01	0	-1.69E+01
Non renewable primary energy as material utilization (PENRM)	MJ	0	0	0	0	0	0
Total use of non renewable primary energy resources (PENRT)	MJ	3.81E+01	1.07E-02	5.92E-02	2.29E-01	0	-1.69E+01
Use of secondary material (SM)	kg	0	0	0	0	0	0
Use of renewable secondary fuels (RSF)	MJ	0	0	0	0	0	0
Use of non renewable secondary fuels (NRSF)	MJ	0	0	0	0	0	0
Use of net fresh water (FW)	m <sup>3</sup>	1.67E-03	1.61E-06	3.48E-06	2.52E-05	0	-9.95E-04

RESULTS OF THE LCA - WASTE CATEGORIES AND OUTPUT FLOWS according to EN 15804+A2: 1 kg I.Girder MT-100 OC

Parameter	Unit	A1-A3	C1	C2	C3	C4	D
Hazardous waste disposed (HWD)	kg	5.16E-10	5.45E-13	1.59E-13	5.05E-12	0	4.42E-11
Non hazardous waste disposed (NHWD)	kg	3.1E-02	2.81E-06	8.63E-06	2.6E-05	0	-2.3E-02
Radioactive waste disposed (RWD)	kg	1.87E-04	9.32E-07	6.19E-08	8.63E-06	0	-9.96E-05
Components for re-use (CRU)	kg	0	0	0	0	0	0
Materials for recycling (MFR)	kg	6.43E-03	0	0	8.5E-01	0	0
Materials for energy recovery (MER)	kg	0	0	0	0	0	0
Exported electrical energy (EEE)	MJ	0	0	0	0	0	0
Exported thermal energy (EET)	MJ	0	0	0	0	0	0

RESULTS OF THE LCA - additional impact categories according to EN 15804+A2-optional: 1 kg I.Girder MT-100 OC

Parameter	Unit	A1-A3	C1	C2	C3	C4	D
Incidence of disease due to PM emissions (PM)	Disease incidence	ND	ND	ND	ND	ND	ND

Human exposure efficiency relative to U235 (IR)	kBq U235 eq	ND	ND	ND	ND	ND	ND
Comparative toxic unit for ecosystems (ETP-fw)	CTUe	ND	ND	ND	ND	ND	ND
Comparative toxic unit for humans (carcinogenic) (HTP-c)	CTUh	ND	ND	ND	ND	ND	ND
Comparative toxic unit for humans (noncarcinogenic) (HTP-nc)	CTUh	ND	ND	ND	ND	ND	ND
Soil quality index (SQP)	SQP	ND	ND	ND	ND	ND	ND

Disclaimer 1 – for the indicator 'Potential Human exposure efficiency relative to U235'. This impact category deals mainly with the eventual impact of low-dose ionizing radiation on human health of the nuclear fuel cycle. It does not consider effects due to possible nuclear accidents, occupational exposure or radioactive waste disposal in underground facilities. Potential ionizing radiation from the soil, from radon and some construction materials is also not measured by this indicator.

Disclaimer 2 – for the indicators 'abiotic depletion potential for non-fossil resources', 'abiotic depletion potential for fossil resources', 'water (user) deprivation potential, deprivation-weighted water consumption', 'potential comparative toxic unit for ecosystems', 'potential comparative toxic unit for humans – cancerogenic', 'Potential comparative toxic unit for humans - not cancerogenic', 'potential soil quality index'. The results of this environmental impact indicator shall be used with care as the uncertainties on these results are high as there is limited experience with the indicator.

## 6. LCA: Interpretation

The dominance analysis shows that the main causes of the environmental impacts and indicators can be found in the information module A1. This shows the total global warming potential for material supply with approx. 50% and approx. 8% in production, based on all information modules.

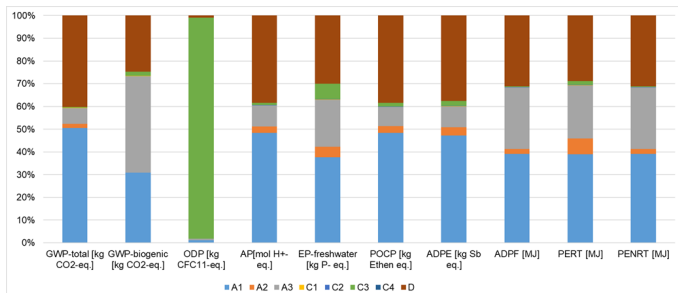

Illustration: Dominance analysis A1- A3

Looking at the material supply of the assembly system and the packaging in the de-tail, it becomes clear which raw materials contribute decisively to the respective environmental impacts and indicators.

The mounting system itself accounts for 99% of the total global warming potential in the A1 information module. Approximately 1% is accounted for by the steel strap.

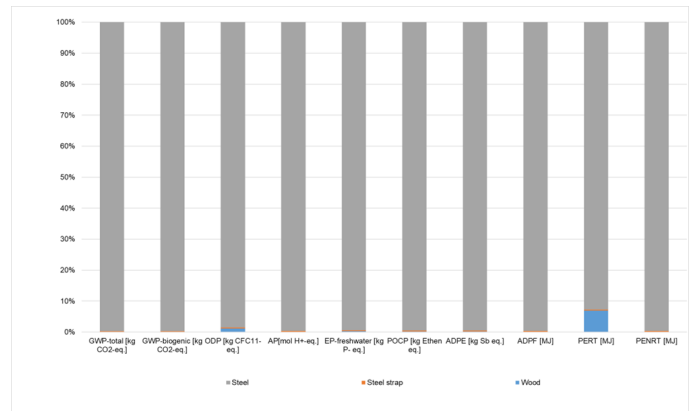

Illustration: Dominance analysis A1

## 7. Requisite evidence

The MT-100 OC may be used to constitute a supporting system to carry the load of cable trays and ladders but is not within scope of the *DIN EN 61537* which is specific to cable tray

systems and cable ladder systems. Therefore, requisite evidence pertaining to this standard shall not be given for this product.

## 8. References

### Standards

#### EN 10346:2015

Continuously hot-dip coated steel flat products for cold forming - Technical delivery conditions

#### EN 15804

EN 15804:2012+A1 2013, Sustainability of construction works — Environmental Product Declarations — Core rules for the product category of construction products.

#### EN 15804

EN 15804:2012+A2:2019+AC:2021, Sustainability of construction works — Environmental Product Declarations — Core rules for the product category of construction products.

#### EN 61537

DIN EN 61537 VDE 0639:2007-09 , Cable management

Cable tray systems and cable ladder systems (IEC 61537:2006); German version EN 61537:2007

#### ISO 9001:2015

Quality management system

#### ISO 14001:2015

Environmental Management System

#### ISO 14025

EN ISO 14025:2011, Environmental labels and declarations — Type III environmental declarations — Principles and procedures



**ISO 15686**

Buildings and constructed assets

**ISO 45001:2018**

Occupational health and safety system

Further references

**Candidate List of substances of very high concern for Authorisation**

European Chemicals Agency (ECHA), in accordance with Article 50(10) of the REACH regulation

**European Technical Approval ETA-21/0414 Hilti Installation channels of MT system**

assessed based on EAD 280016-00-0602 'Products for installation systems for supporting technical building equipment'

**European Technical Approval ETA-23/0105****European Waste code**

in accordance with the European Waste Catalogue (EWC) (EWC 2014/955/EU) Commission Decision amending Decision 2000/532/EC on the list of waste pursuant to Directive 2008/98/EC of the European Parliament and of the Council

**IBU 2021**

General Instructions for the EPD programme of Institut Bauen und Umwelt e.V. Version 2.0, Berlin: Institut Bauen und Umwelt

e.V.,2021 [www.ibu-epd.de](http://www.ibu-epd.de)

**PCR Part A**

Institut Bauen und Umwelt e.V, Berlin (pub.): Product Category Rules for Construction Products from the range of Environmental Product Declarations for Institut Bauen und Umwelt (IBU), Part A: Calculation Rules for the Life Cycle Assessment and Requirements on the Project Report according to EN 15804+A2:2019, 202108

**PCR Part B**

Connection, assembly and installation systems,.10.2022

**Regulation (EU) No. 305/2011 (CPR)**

Regulation (EU) No 305/2011 of the European Parliament and of the Council of 9 March 2011 laying down harmonised conditions for the marketing of construction products and repealing Council Directive 89/106/EEC Text with EEA relevance

**Sphera**

LCA for Experts: Ganzheitliche Bilanzierung  
Leinfelden-Echterdingen; Sphera Solution GmbH (Hrsg.)  
<http://www.gabi-software.com/deutsch/index/>

**World steel association**

<https://www.worldsteel.org/steel-topics/raw-materials/>



**Publisher**

Institut Bauen und Umwelt e.V.  
Hegelplatz 1  
10117 Berlin  
Germany

+49 (0)30 3087748- 0  
info@ibu-epd.com  
www.ibu-epd.com

---



**Programme holder**

Institut Bauen und Umwelt e.V.  
Hegelplatz 1  
10117 Berlin  
Germany

+49 (0)30 3087748- 0  
info@ibu-epd.com  
www.ibu-epd.com

---



**Author of the Life Cycle Assessment**

FIT-Umwelttechnik GmbH  
Westerstr. 13  
38442 Wolfsburg  
Germany

05362 72 69 474  
bertram@fit-umwelttechnik.de  
www.fit-umwelttechnik.com

---



**Owner of the Declaration**

Hilti Aktiengesellschaft  
Feldkircher Strasse 100  
9494 Schaan  
Liechtenstein

+423 234 2111  
HAGHSE@hilti.com  
www.hilti.com