



# STEEL-TO-CONCRETE CONNECTIONS

Using Post-installed Systems



Handbook, ver. 1.0  
January, 2025



# Table of Contents

<b>FOREWORD</b>	<b>8</b>
<b>1. Introduction</b>	<b>9</b>
<b>2. Applications</b>	<b>10</b>
<b>2.1</b> Elements for fastenings	<b>11</b>
<b>2.2</b> Types of connections	<b>12</b>
2.2.1 Primary connections	<b>13</b>
2.2.2 Secondary connections	<b>13</b>
2.2.3 Temporary connections	<b>14</b>
2.2.4 Non-structural connections	<b>14</b>
<b>3. Post-installed fastening systems</b>	<b>16</b>
<b>3.1</b> Load-bearing mechanisms	<b>16</b>
<b>3.2</b> Classification of fasteners	<b>17</b>
3.2.1 Mechanical anchors	<b>17</b>
3.2.2 Bonded anchors	<b>18</b>
3.2.3 Combined mechanical and bonded anchors	<b>18</b>
<b>3.3</b> Types of setting	<b>19</b>
<b>3.4</b> Loading directions	<b>19</b>
<b>3.5</b> Types of loading	<b>20</b>
<b>3.6</b> Failure modes of anchors	<b>22</b>
3.6.1 Failure modes under tension loading	<b>22</b>
3.6.2 Failure modes under shear loading	<b>24</b>
<b>3.7</b> Factors influencing the performance of anchors	<b>25</b>
3.7.1 Base material	<b>26</b>
3.7.2 Installation	<b>27</b>
3.7.3 Environmental conditions	<b>28</b>
3.7.4 Loading types	<b>28</b>
<b>4. Regulatory framework for qualification and design</b>	<b>31</b>
<b>4.1</b> Overview of European regulatory framework	<b>31</b>
<b>4.2</b> Design and qualification of post-installed anchors	<b>33</b>
<b>4.3</b> Design of post-installed anchors	<b>34</b>
4.3.1 Design and applications covered by EC2-4	<b>34</b>
4.3.2 Design of anchors under fatigue loading (EOTA TR 061)	<b>34</b>
4.3.3 Design of bonded screw anchors (EOTA TR 075)	<b>35</b>

4.3.4	Design of bonded anchors under fire exposure (EOTA TR 082)	35
<b>4.4</b>	<b>Qualification of post-installed anchors</b>	<b>35</b>
4.4.1	Qualification of mechanical anchors as per EAD 330232	35
4.4.2	Qualification of bonded and bonded expansion anchors as per EAD 330499	36
4.4.3	Qualification of mechanical and bonded anchors as per EAD 330250	37
4.4.4	Qualification of bonded screw anchors as per EAD 332795	38
<b>5.</b>	<b>Hilti solutions</b>	<b>40</b>
<b>5.1</b>	<b>Criteria for selecting an anchor type</b>	<b>40</b>
5.1.1	Base material as concrete and its properties	40
5.1.2	Anchor setting and configurations	41
5.1.3	Loading type	41
5.1.4	Loading distribution in group of anchors	41
5.1.5	Environmental conditions	42
<b>5.2</b>	<b>Hilti solutions</b>	<b>43</b>
<b>5.3</b>	<b>Mechanical or bonded anchor: when to use which?</b>	<b>46</b>
<b>5.4</b>	<b>Hilti as total solution provider</b>	<b>46</b>
<b>5.5</b>	<b>Design and installation steps</b>	<b>47</b>
<b>5.6</b>	<b>SPEC2SITE solutions</b>	<b>48</b>
<b>6.</b>	<b>Design of anchors</b>	<b>49</b>
<b>6.1</b>	<b>Design principles</b>	<b>49</b>
<b>6.2</b>	<b>Anchor configurations permitted as per EC2-4</b>	<b>49</b>
<b>6.3</b>	<b>Actions on fasteners (rigid vs. flexible baseplate)</b>	<b>50</b>
6.3.1	Analysis of tension loads	51
6.3.2	Analysis of shear loads	51
<b>6.4</b>	<b>Alternative approaches for distribution of shear force as in fib Bulletin 58</b>	<b>53</b>
<b>6.5</b>	<b>SOFA method</b>	<b>53</b>
6.5.1	Shear distribution and anchor layout covered in SOFA method	53
6.5.2	SOFA gives higher resistance for grouted and ungrouted stand-off applications	54
<b>6.6</b>	<b>Design of anchors for static loading as per EC2-4</b>	<b>57</b>
6.6.1	Verifications of anchors under tension loading	57
6.6.1.1	Steel failure	59
6.6.1.2	Concrete cone failure	59
6.6.1.3	Concrete pull-out failure	61
6.6.1.4	Concrete splitting failure	61
6.6.1.5	Combined pull-out and concrete cone failure	63

6.6.1.6	Combined pull-out and concrete cone failure for hybrid (bonded concrete screw) system as per EOTA TR 075	64
6.6.1.7	Concrete blow-out failure	65
6.6.1.8	Checklist to improve an anchor's performance against tension-related failure modes	66
6.6.2	Verifications for anchors under shear loading	67
6.6.2.1	Steel failure without lever arm	67
6.6.2.2	Steel failure with lever arm	68
6.6.2.3	Concrete pry-out failure	68
6.6.2.4	Concrete edge failure	69
6.6.2.5	Checklist to improve an anchor's performance against shear related failure modes	71
<b>6.7</b>	<b>Design considering supplementary reinforcement as per EC2-4</b>	<b>71</b>
6.7.1	Supplementary reinforcement designed for resistance against tension load	72
6.7.1.1	Steel failure	72
6.7.1.2	Anchorage failure	73
6.7.2	Supplementary reinforcement designed for resistance against shear load	73
6.7.2.1	Steel failure	73
6.7.2.2	Anchorage failure	74
<b>6.8</b>	<b>Interaction between tension and shear loading</b>	<b>74</b>
<b>6.9</b>	<b>Design example of post-installed anchors for static loading</b>	<b>75</b>
6.9.1	Design for static loading without supplementary reinforcement	75
6.9.1.1	Design example for mechanical expansion anchors	75
6.9.1.2	Design example for concrete screw anchor	80
6.9.2	Design for static loading with supplementary reinforcement	85
<b>6.10</b>	<b>Design against seismic actions as per EC2-4</b>	<b>89</b>
6.10.1	Determination of seismic actions	90
6.10.1.1	Vertical seismic actions	90
6.10.1.2	Horizontal seismic actions	91
6.10.2	Determination of seismic resistance of anchors	92
6.10.2.1	Capacity design	93
6.10.2.2	Elastic design	94
6.10.2.3	Design considering ductility of anchors	94
6.10.2.4	Displacement of fasteners for seismic action	96
6.10.3	Design example of post-installed anchors against seismic loading	96
<b>6.11</b>	<b>Design under fire exposure as per EC2-4 and EOTA TR 082</b>	<b>102</b>
6.11.1	Design against fire condition as per EC2-4	103
6.11.1.1	Design check for tension loading	104
6.11.1.2	Design checks for shear load	105

6.11.2	Design against fire condition as per EOTA TR 082	106
6.11.2.1	Simplified method	107
6.11.2.2	Resistance integration method	108
6.11.3	Design example of post-installed anchor against fire loading	110
6.11.3.1	Design example of mechanical anchors	110
6.11.3.2	Design example of chemical anchors	113
<b>6.12</b>	<b>Design against fatigue condition as per EC2-4 and EOTA TR 061</b>	<b>118</b>
6.12.1	Design scope and verification according to EC2-4 and EOTA TR 061	118
6.12.2	Design methods according to EOTA TR 061	121
6.12.2.1	Method I - Complete method	124
6.12.2.2	Method II - Simplified method	125
6.12.3	Design example of post-installed anchors against fatigue loading	125
6.12.3.1	Design example against high cycle fatigue load	125
6.12.3.2	Design example against lower cycle fatigue load	130
<b>6.13</b>	<b>Design of post-installed fastenings-EC2-4 (simplified methods)</b>	<b>132</b>
6.13.1	Design according to method A	132
6.13.2	Design according to method B	132
6.13.3	Design according to method C	132
<b>6.14</b>	<b>Design of redundant non-structural fastening as per EC2-4 and CEN/TR 17079</b>	<b>133</b>
<b>6.15</b>	<b>Verification of concrete elements due to loads applied by fastenings</b>	<b>133</b>
<b>7.</b>	<b>PROFIS Engineering Suite – software design</b>	<b>135</b>
7.1	Introduction	135
7.2	Why use PROFIS Engineering Suite?	135
7.3	Design of post-installed anchors for S2C applications in PROFIS	136
7.3.1	Concrete properties and installation conditions	136
7.3.2	Concrete reinforcement and supplementary reinforcement	137
7.3.3	Baseplate type selection	137
7.3.4	Steel profile selection	138
7.3.5	Calculation types available in PROFIS: stiff vs. flexible baseplate	138
7.3.6	Profis helps to choose the suitable anchor for specific applications	140
7.3.7	Loading types in PROFIS	141
7.3.8	Design output, reports and drawings	141
<b>8.</b>	<b>Installation and inspection</b>	<b>143</b>
8.1	Introduction	143
8.2	What does Eurocode require for a proper specification?	143

<b>8.3</b>	What are the installation steps to be followed by the contractor?	<b>144</b>
8.3.1	Positioning of baseplate/boreholes	<b>145</b>
8.3.2	Drilling of boreholes in concrete	<b>146</b>
8.3.2.1	Rotary-impact drills (hammer drills/ HD) equipped with standard or cruciform carbide bits)	<b>147</b>
8.3.2.2	Diamond-core drills utilizing either wet or dry coring technology (DD)	<b>147</b>
8.3.3	Borehole cleaning	<b>148</b>
8.3.4	Anchor setting (mechanical anchors)	<b>148</b>
8.3.5	Mortar injection (only for chemical anchors)	<b>149</b>
8.3.6	Improving jobsite practices with spec2SITE solutions	<b>151</b>
8.3.7	Hilti TraceFast technology	<b>153</b>
<b>8.4</b>	Inspection, testing and quality control	<b>154</b>
<b>8.5</b>	Construction specifications	<b>156</b>
<b>8.6</b>	Hilti for engineering support	<b>156</b>
<b>9.</b>	<b>Reference projects</b>	<b>158</b>
<b>9.1</b>	Bridge 231, Brno, Czech Republic	<b>158</b>
<b>9.2</b>	The prestige Mahalakshmi project in Mumbai, India	<b>160</b>
<b>9.3</b>	UOB renovation project, Thailand	<b>162</b>
<b>9.4</b>	MAHSR Track works package, Gujarat, India	<b>164</b>
<b>9.5</b>	Kai Tak Sport Park, Hong Kong	<b>166</b>
<b>Authors</b>		<b>168</b>
<b>Acknowledgements</b>		<b>168</b>
<b>References</b>		<b>169</b>

## FOREWORD

by

**Sara Cattaneo**

**Full Professor, Politecnico di Milano, Italy**

**Dept. of Architecture, Built Environment and Construction Engineering**



In the ever-evolving landscape of construction and infrastructure development, requirements of automation and structural versatility justify the wide use of post-installed systems both for retrofit and in new constructions. For this reason, many efforts have been made in the last few decades to develop different types of reliable fasteners and suitable design methods to address complex structural and non-structural demands. The design of a steel-to-concrete connections requires careful choices from a multitude of fastening systems (mechanical, chemical, etc.) considering the different conditions of use (dimensional limits, particular load, and environmental conditions).

This handbook is designed as a comprehensive guide to help you navigate the intricate realm of the design and execution of post-installed fasteners in steel-to-concrete connections. It delves into the nuances of selecting, installing and assessing their performance, offering a wealth of knowledge to empower professionals who are not familiar with the fastening world or want to improve their expertise. As we embark on this exploration, it is important to acknowledge the collaborative efforts of Hilti, which has contributed to the advancement of this field. Its research, shared experiences and commitment to excellence have paved the way for the compilation of this handbook which aims to be a landmark for those seeking clarity in the challenging domain of steel-to-concrete connections.

The handbook unfolds in a logical sequence, guiding readers through the fundamentals of the fastening systems, moving from the load-bearing mechanisms and, consequently, to the classification of fasteners, up to the failure modes under different load directions and the factors influencing the performance of fasteners.

One crucial chapter relates to the regulatory framework for qualification and design, reporting the history of the development of qualification methods and design approaches and their most recent updates.

The reader will find a clear and concise explanation of the fields of applicability and of the limits of each document. Finally, the “Hilti solutions” chapter is fundamental to helping practitioners select the most suitable solution for their specific project, considering the different situations they could face.

The key design chapter guides the designer in advanced design. Indeed, if the Eurocode 2 design approach is recalled in detail on the one hand, alternative design methods are also presented on the other, based on documents of proven scientific validity (fib, EOTA TR). These methods, known only to experts in the subject, sometimes allow you to design connections that are not covered by Eurocode 2-4 (e.g., connections with flexible plates). In each section, readers will find a blend of theoretical knowledge and practical insight, supported by case studies and examples.

Although the reader will be able to design steel-to-concrete connections “by hand”, Hilti provides a useful user-friendly software tool (PROFIS Engineering Suite) which allows the designer to optimize the solution quickly while avoiding manual errors. A brief software manual together with explanation of installation and inspection procedures are at the end of the handbook giving a comprehensive overview of steel-to-concrete connections.

As the construction industry evolves, it must be supported by our understanding of the technologies that are involved in its progress. This handbook, therefore, is a guide to current best practices and emerging trends. It is an essential aid for a designer, who is helped in choosing the system and parameters to optimize a connection. I think that this manual is a valuable resource for those who are new to the world of steel-to-concrete connections, as well as for those who, already being experts, are engaged in innovative projects that require the utmost expertise.



# 1. INTRODUCTION

Today's construction industry is a very dynamic environment due to productivity requirements, changing client requirements, misplacement of connections, political and economic factors, change in local regulations and more. Designers/engineers might need to amend a design numerous times, accommodating possible changes and providing a modified design that complies with a suitable code. In general, it is common practice to attach structural and non-structural elements to reinforced concrete members cast at a previous point in time by using **post-installed connections**. The development of these solutions over the past 40+ years has made them a reliable option to save time in the design of every single detail prior to the casting of concrete members of a structure, as well as for connection in existing constructions. In some cases, the post-installed connections are required to repair and retrofit existing structures to enhance structural safety, durability and strength. Among the many kinds of applications possible for connecting a new member to an old or existing structure (e.g., steel plates/sections to old concrete, a new concrete member to old concrete, a new steel section to old steel), this handbook focuses the fixing of steel sections to concrete members. These are called **steel-to-concrete (S2C) connections** ([Chapter 2](#)).

This handbook helps you to understand state-of-the-art load bearing mechanisms ([Chapter 3](#)) and the regulatory framework for the qualification and design of post-installed S2C connections ([Chapter 4](#)). Hilti solutions, comprising various types of fastening systems, are also introduced ([Chapter 5](#)), allowing you to choose the most suitable for a specific application. It also contains detailed design methods for various load types and environmental conditions such as static, seismic, fire and fatigue, as per European regulations ([Chapter 6](#)). Additionally, special features of Hilti design software (PROFIS Engineering) are described ([Chapter 7](#)). Installation and inspection aspects, which are very relevant to ensure adequate performance of designed fasteners, are also covered ([Chapter 8](#)). At the end of the handbook some reference projects where the structures were equipped with Hilti post-installed anchor systems are included ([Chapter 9](#)).

The primary intention of this handbook is to provide guidance to the engineers involved in designing S2C connections. Furthermore, it is also useful for contractors, in-house technical teams and others who are directly or indirectly associated with such applications.



## 2. APPLICATIONS

On a jobsite, many different types of steel-to-concrete (S2C) connections may be present. S2C connections are required for both structural and non-structural applications. This type of connections is already well established among designers for many kinds of projects, such as buildings, infrastructure, industrial applications and many other areas. Among the category of **structural connections**, members such as steel columns, beams and bracings that transfer loads to concrete can be often found. **Non-structural connections** include the fixing of utilities, equipment, façade and many more applications that are key elements for the functioning of a building or a civil structure. If cast-in connecting elements such as headed bolts or anchor channels are misplaced, we may encounter **unplanned** applications. If a project needs flexibility, post-installed anchors are a handy solution (**planned** applications). Some typical S2C applications for building constructions are illustrated below in Fig. 2.1 and Fig. 2.2.

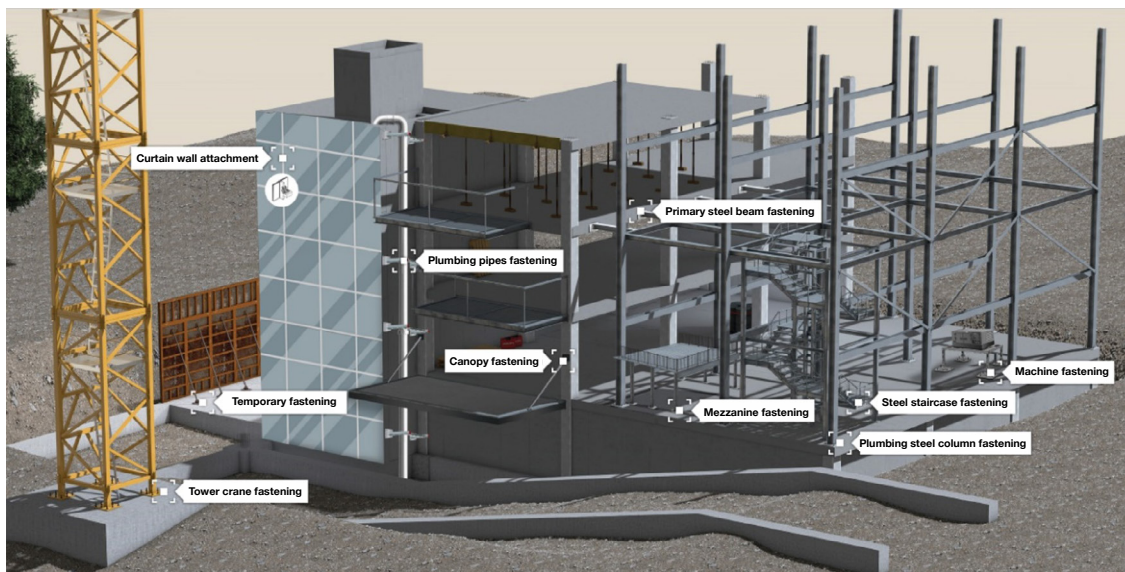

Fig. 2.1: Illustration of typical applications in a building under construction

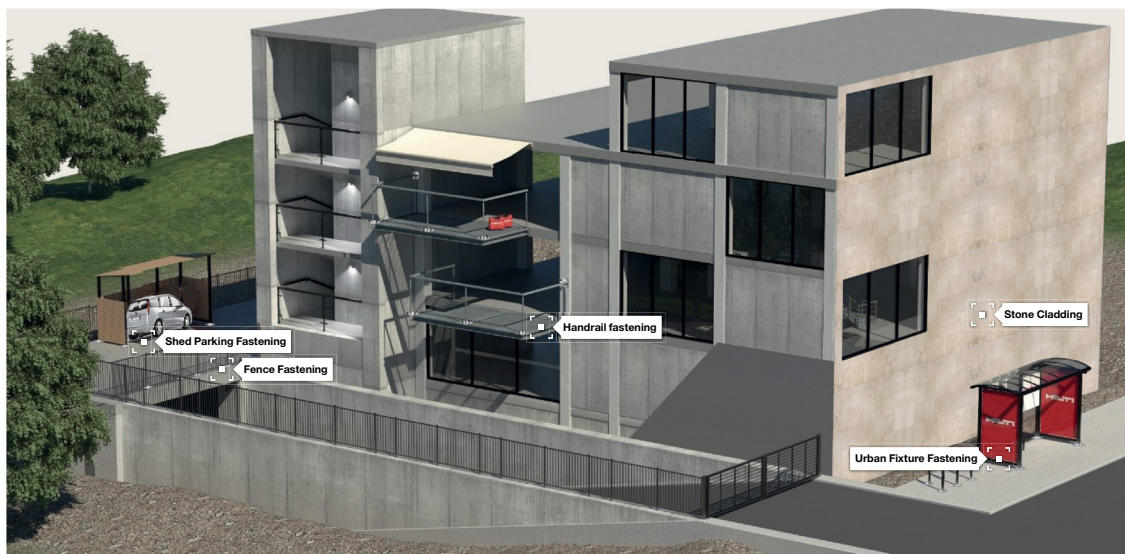

Fig. 2.2: Illustration of typical applications for building finishings

The illustration Fig. 2.3 displays typical examples of both S2C and concrete-to-concrete (C2C) applications in bridges. These applications involve the use of fastening to concrete. For the C2C connections using post-installed rebars, extension of pier cap and concrete overlay, please check the Hilti C2C handbook for more details.

**Note:** C2C handbook provides guidance for post-installed rebars in C2C connections.

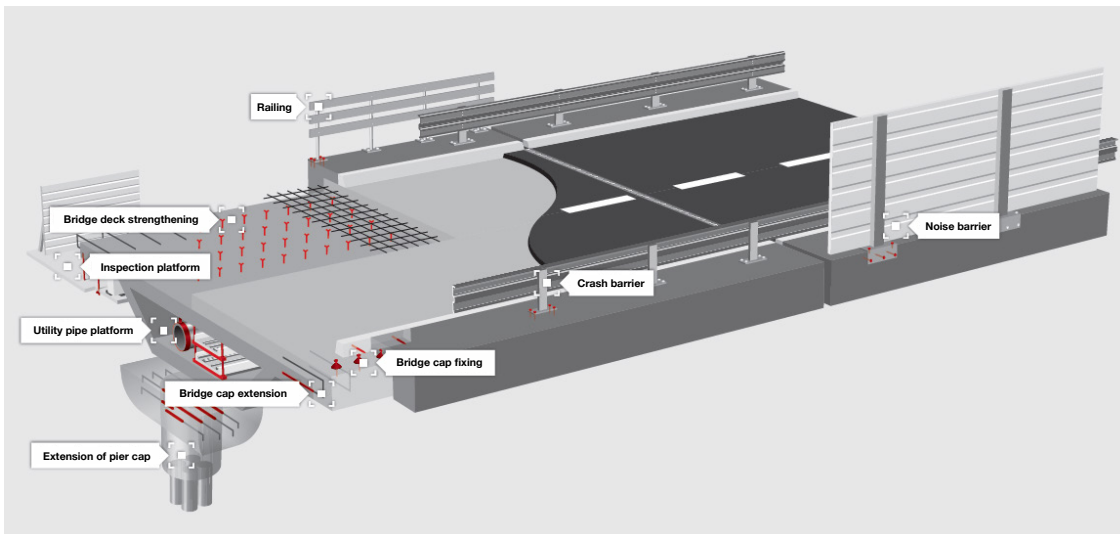

Fig. 2.3: Illustrations of typical applications for jobsite bridges

The application of post-installed connections is often found in tunnel structures as well. Fig. 2.4 shows the locations where steel baseplates are fixed in concrete using post-installed anchors.

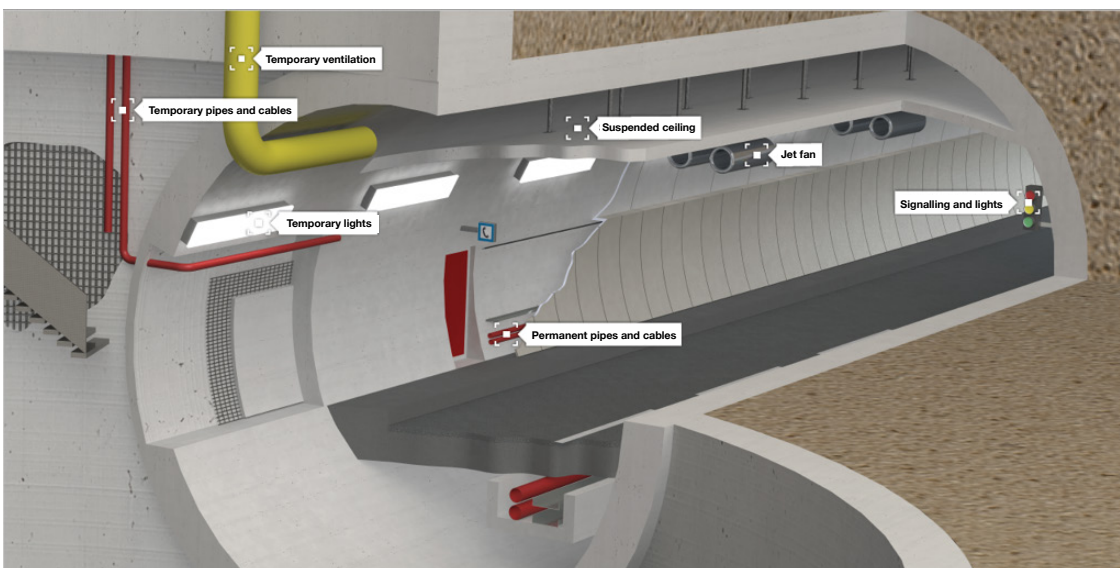

Fig. 2.4: Illustration of typical applications for tunnel structures

## 2.1 Elements for fastenings

Some basic terms commonly used in the practice of fastening technology are listed and explained in the following points and in Fig. 2.5.

**Anchor:** element used to connect (i.e., transfer loads from) structural and non-structural elements to the base material. It is generally made of steel. Some anchor types are used in combination with high-performance chemicals to ensure a bond with the surrounding concrete.

**Attachment:** metal assembly that transmits loads to the anchor, usually composed of the baseplate and welded stiffeners to connect it to a metal profile.

**Base material:** the material to which the load is transferred from the steel structure by the fasteners (the material can be concrete, masonry, timber, natural stone, etc.). In this handbook we will focus only on concrete. Concrete can be of normal weight or a special type: aerated, lightweight, fiber-reinforced etc. The properties of the base material play a decisive role when selecting a suitable fastener and determining the load it can hold.

**Baseplate:** a steel plate placed between members such as columns or beams and the base material to distribute the applied loads. This is used to connect a metal profile to the base material.

**Metal profile:** the element which has been rolled, drawn or pressed into a shape and is attached to the baseplate.

**Weld:** a joint formed by uniting two or more pieces of metal by means of heat, pressure, or both, as the parts cool down (e.g., connection between metal profile and baseplate).

**Stand-off (grouted or not):** baseplates are often elevated from the concrete surface due to levelling, inclination or other reasons. This stand-off gap between the baseplate and the concrete surface is often filled with grout for improving bearing and bending resistance.

**Stiffeners:** these are secondary plates which are attached to webs or flanges of the steel profile to stiffen them against deformations.

**Fasteners:** see anchor.

**Fastenings:** assembly of baseplate and group of anchors/fasteners.

**Note:** In this handbook the terms “fastener” and “anchor” are used as synonyms.

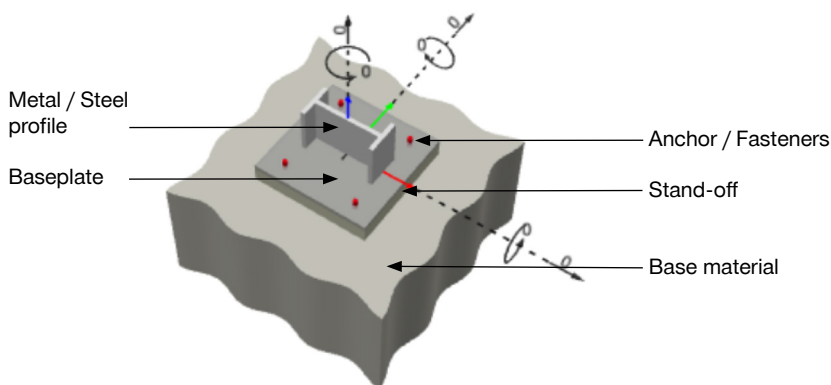

Fig. 2.5: Elements in steel-to-concrete connections

## 2.2 Types of connections

Usually, in a building or a civil infrastructure, multiple types of connections may be present. Depending upon the application type, loads acting on the fixture and the design requirements, the following

categories may be distinguished as shown in Fig. 2.6. The main common characteristic of these types of connections within the framework of this handbook is that they are **safety relevant**. This means that their failure may endanger human lives and/or cause significant economic losses. Non-safety relevant connections are out of the scope of this handbook. Fencing and small signage are examples of low or non-engineered connections.

**Structural connections** are mainly the connections between different type of structural elements which may be primary or secondary load-bearing members, and in some cases, temporary structures that are required during the construction process. They are integral to the stability and load-bearing capacity of a structure.

With **non-structural connections**, the attachment of different elements to the main structures is addressed, e.g., cables, pipes, machines, and handrails. These play a significant role in the function, architecture or aesthetic appearance of a building/infrastructure without directly affecting the structural integrity.

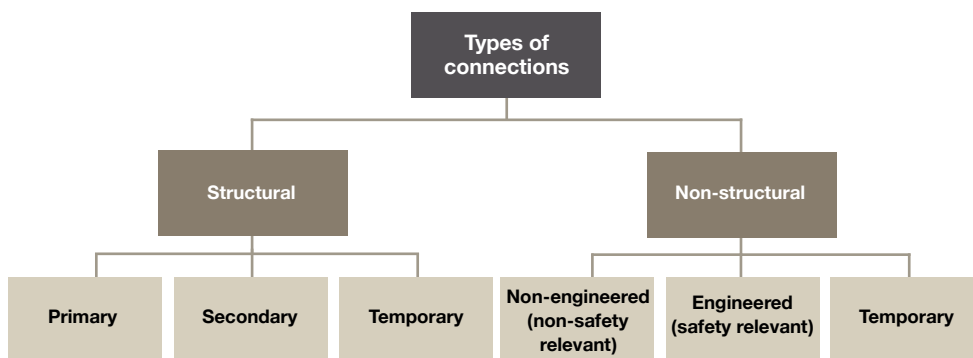

Fig. 2.6: Different types of connections

### 2.2.1 Primary connections

Steel members that form a part of the main structural system of a building carry load and transfer it to the base material through baseplate and anchors, these are called primary connections. Usually, anchors of medium to large diameter are used (i.e., 16 mm and above) depending upon the load and other conditions. Some examples of primary connections are columns, beams, girders, heavy brackets and bracings (see Fig. 2.7).



a) Primary steel column



b) Primary steel beam

Fig.2.7: Examples of primary connections

### 2.2.2 Secondary connections

These are the connections that support the load-carrying members of a structure but are not vital to its overall integrity. They are safety-relevant and, therefore, are usually uniquely designed. For secondary connections, loads are transferred with fastening solutions generally of medium diameter ranging from

12 mm to 20 mm. Some examples of secondary connections are mezzanine, balconies, canopies and platform fixing staircases as shown in Fig. 2.8.



a) Mezzanine



b) Balconies



c) Canopies



d) Steel staircase

Fig. 2.8: Examples of secondary connections

### 2.2.3 Temporary connections

These are connections which are only needed for a short period of time and are removed afterwards. They may support the structure and/or increase workers' safety during the construction phase. Anchor diameters in these applications may range across the full spectrum from small to large diameters. While a diameter of 8 mm to 12 mm may usually be sufficient for handrail fastenings, large diameters beyond 20 mm are commonly used for large crane fastenings. Some examples of engineered temporary connections are earth-retaining structures, propping/shoring, formworks, and crane supports (see Fig. 2.9).



a) Temporary wall support



b) Tower crane support

Fig. 2.9: Examples of temporary connection

### 2.2.4 Non-structural connections

Non-structural connections in this handbook are safety relevant, since the loads are large enough to endanger human lives or create significant economic losses in case of failure. Non-structural elements of a building are not a part of the main load-resisting system and used for light steel structures fastened in concrete, masonry, etc. Inadequate design of non-structural connections can be fatal for the building with respect to performance and functionality. Some examples of non-structural connections are handrails, fences, fastening of seats, cable tray connections, pipe connections, etc. as shown in Fig. 2.10. In these

**Note:** If a connection is non-structural, it does not mean it is not safety relevant!

cases, loads are usually transferred to base material using fastening solutions ranging from diameter 8 mm to 12 mm.



a) Handrails

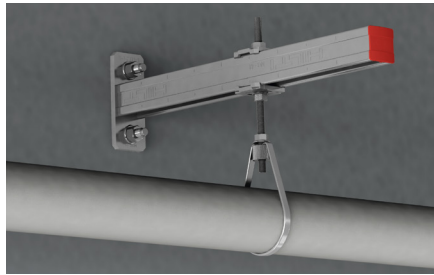

b) Fixing of sprinkler pipes

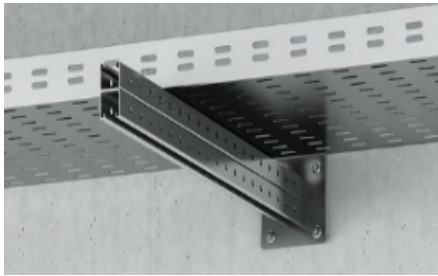

c) Support system for electrical installations

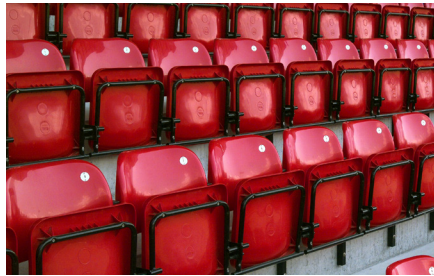

d) Seats in stadium

Fig. 2.10: Examples of non-structural connection

### 3. POST-INSTALLED FASTENING SYSTEMS

#### 3.1 Load-bearing mechanisms

Fastening systems transfer applied loads to the base material in different ways. Under both tension (Fig. 3.1 a)) and shear loading (Fig. 3.1 b)), the load transfer mechanism involves the utilization of concrete tensile strength. We refer in this case to **fastening design theory** in opposition to the reinforced concrete theory, where the concrete tensile strength is usually neglected in design. The load-transfer mechanisms for various fastening systems are typically identified as **mechanical interlock, friction, and adhesive bond** mechanisms.

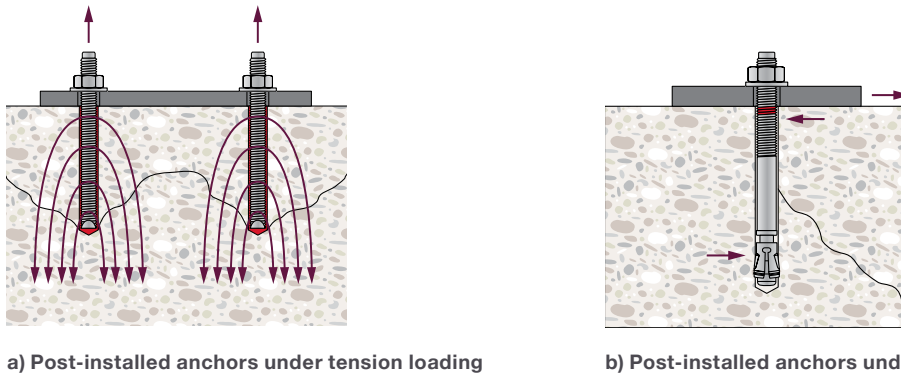

Fig. 3.1: Illustration of tensile capacity of concrete being utilized for load transfer by post-installed anchors (fastening design theory)

**Mechanical interlock/keying** defines the working principle where the load is transferred by means of a bearing surface between the anchor and the base material (see Fig. 3.2 a)). Some post-installed fasteners develop a mechanical interlock between the anchor and the base material. To achieve this, a cylindrically drilled hole is modified to create a notch, or undercut, of a specific dimension at a defined location either by means of a special drill bit, or by the undercutting action of the anchor itself.

**Note:** Most of the fasteners utilize one or more of the mechanisms described in this section.

**Friction mechanism** is the load-transfer mechanism typical of systems where expansion force is generated by a clip or a wedge pressed against the walls of the borehole during the installation process. Frictional resistance equilibrates the external tension force on anchors. The tensile load,  $N$ , is transferred to the base material by friction,  $R$  (Fig. 3.2 b)).

**Adhesive bond mechanism** involves the transfer of the external load to the concrete base material via an adhesive bond (see Fig. 3.2 c)). The forces are transferred from the anchor element (e.g., a threaded rod) to the mortar via mechanical interlocking and to the base material via a combination of micro-interlock and chemical adhesion between the mortar and the lateral surface of the borehole.

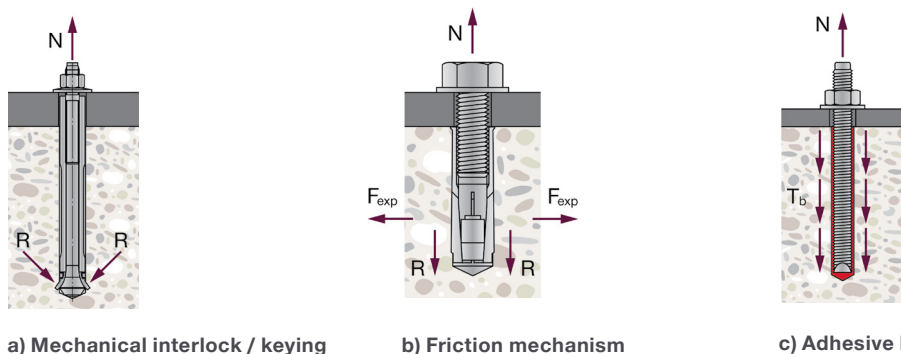

Fig. 3.2: Different types of load-bearing mechanisms in fastening technology



### 3.2 Classification of fasteners

Post-installed fasteners transfer load from the baseplate to the concrete through different working principles, as mentioned in [Section 3.1](#). They may be broadly classified as **mechanical** and **bonded** anchors (see Fig. 3.3). Mechanical anchors derive their strength from principles like friction and keying between steel and concrete. On the other hand, bonded anchors derive their strength from the bond along the interfaces between steel-adhesive and adhesive-concrete. Some systems combine the characteristics of mechanical and bonded anchors.

Note: See [Chapter 5](#) for the Hilti offer of each anchor type.

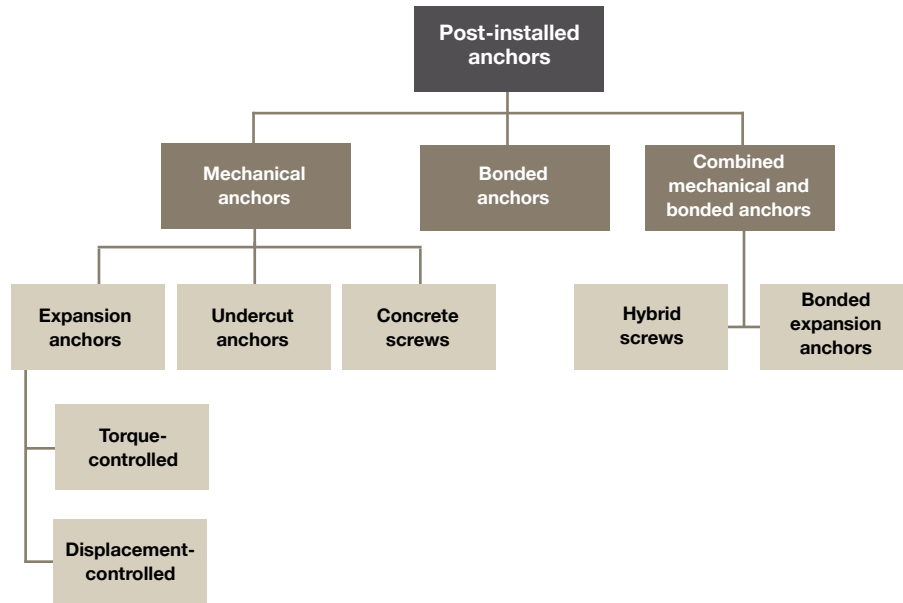

Fig. 3.3: Classification of post-installed anchors

#### 3.2.1 Mechanical anchors

These fastening systems rely on mechanical principles like friction, keying, or a combination of them, for transferring the load to the base material. Mechanical anchors may be further classified as follows:

**Expansion anchor:** these mechanical anchors derive their load-carrying capacity from the frictions generated by the expansion of a sleeve against the sides of the drilled hole. Based on how the expansion of sleeve is induced, expansion anchors may be further classified into the following two types:

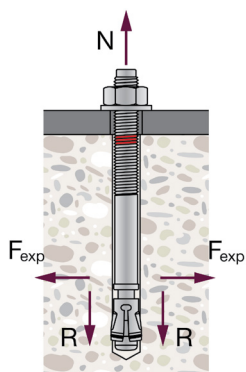

Fig. 3.4: Torque-controlled expansion anchor

**Torque-controlled expansion anchor:** this anchor type induces expansion of the sleeve through the application of a torque. As the “predefined” torque is applied on the nut, the cone is pulled into the sleeve, thereby causing it to expand and press against the wall of the drilled hole. These anchors transfer forces to the base material mainly through friction. Torque-controlled expansion anchors can be of a sleeve or bolt type. A sleeve type anchor has a bolt or threaded rod, nut, washer, spacer and expansion sleeve. A bolt type anchor has bolts with a swagged conical shaped end with a nut, washer and expansion clip. The expansion sleeve/clip is expanded by a cone. An illustration of this anchor type is shown in Fig. 3.4.

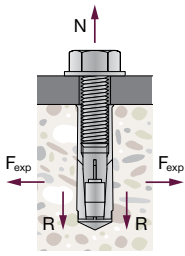

Fig. 3.5: Displacement-controlled expansion anchor

**Displacement-controlled expansion anchor:** these expansion anchors consist of an expansion sleeve and conical expansion plug.

They are set in place by expanding the sleeve through controlled deformation. This is achieved either by driving the cone into the sleeve or the sleeve over the cone, as illustrated in Fig. 3.5.

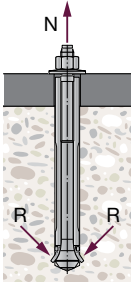

Fig. 3.6: Undercut anchor

**Undercut anchor:** these mechanical anchors derive their load-carrying capacity from the mechanical interlock provided by undercutting of the concrete at the embedded end of the fastener. Usually, a special drill is used to create the undercut prior to installation of the anchor (see Fig. 3.6). Alternatively, the undercut may be created by the anchor itself during its installation. Undercut anchors consist of a conical end threaded stud, nut, washer and undercut sleeve. Unlike expansion anchors, undercut anchors generate small or no expansion forces during installation.

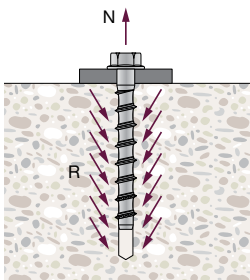

Fig. 3.7: Screw anchor

**Screw anchor:** these mechanical anchors derive their load-carrying capacity from the mechanical interlock provided by the undercutting of concrete along the length of the fastener. These anchors are screwed into a pre-drilled cylindrical hole and during this process, the thread of the concrete screw cuts itself into the concrete thereby creating the mechanical interlock. An illustration of this anchor type is shown in Fig. 3.7.

### 3.2.2 Bonded anchors

These anchors utilize the property of the adhesive to form a bond between a chemical adhesive-concrete interface and a chemical adhesive-fastener interface, thereby developing the load-carrying capacity (Fig. 3.2 c)). The adhesive may be organic (e.g., epoxy, polyester, vinyl-ester) or inorganic (i.e., cement based). Adhesives usually have resin and a hardener component. They can be delivered in injectable cartridge/foil pack systems or in glass/foil capsule systems (see [Chapter 5](#)). When the two components are mixed together, the adhesive hardens and achieves its bond properties. The adhesive is placed in a drilled, cleaned hole and the fastening element (e.g., threaded rod, sleeve with internally threaded rod etc.) is then inserted. These systems can be loaded only after the adhesive has cured and hardened. The curing time may differ from product to product and environmental conditions (mainly temperature) and it is specified by the manufacturer. Post-installed bonded anchors offer high flexibility in design and can be tailored to a wide range of diameters and embedment depths.

### 3.2.3 Combined mechanical and bonded anchors

Some anchors work on the principle of combining one of the mechanical actions described earlier with bond action. Two types are described in the following:

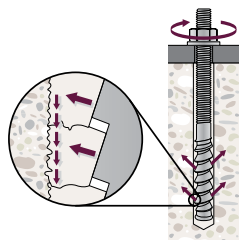

Fig. 3.8: Bonded expansion anchor

**Bonded expansion anchor:** the fastening element used is a special threaded rod with multiple steel cones in the bottom portion of the rod (see Fig. 3.8). It has a coating that allows the bond to break at the concrete-adhesive interface with the application of “predefined” torque after an initial loading which is resisted by the bond. After the breaking of the bond, the hardened adhesive acts as multiple expansion clips between each cone and concrete. Therefore, these fasteners essentially combine the working principle of torque-controlled expansion anchors and bonded anchors.

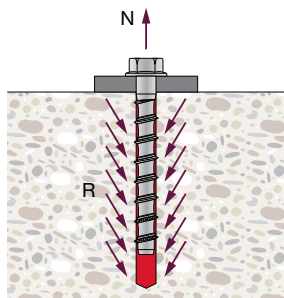

Fig. 3.9: Bonded screw anchor

**Hybrid screw anchor:** this anchor derives the load-carrying capacity from the mechanical interlock provided by the undercutting of concrete along the length of the anchor combined with the adhesive bond of the chemical used in the drilled hole. It can be considered as a hybrid between a concrete screw and a bonded anchor. This system employs a concrete screw with a hexagonal head or outer thread in conjunction with a foil capsule filled with the constituent bonding materials or an injection system (refer to Fig. 3.9).

### 3.3 Types of setting

From the perspective of setting process, post-installed anchors may be broadly classified as **pre-set** or **through-set**. In the case of the pre-set type, the anchor is installed first and then the fixture is placed in position as shown in Fig. 3.10 a). The holes in the fixture must exactly match the anchor location in the base material. In the case of the through-set type, the fixture is held in position and then the anchor is installed through it as shown in Fig. 3.10 b). Depending on the application, the structural designer or the installer may prefer to use either of the two types.

**Note:** Not all types of anchors are suitable for both setting modes, refer to [Chapter 5](#).

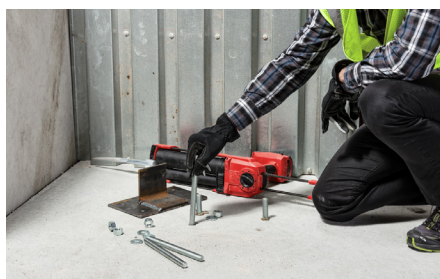

a) Pre-setting



b) Through-setting

Fig. 3.10: Classification of setting type for post-installed anchors

### 3.4 Loading directions

The forces acting on fastening systems can be determined using the principle of structural mechanics. The distribution of forces acting on an attachment of an anchor group to the individual anchors of the group can be calculated using elastic theory or non-linear methods. The actions on the fixture such as tension, shear, bending or torsion moments (or any combination thereof) results in the loading on the anchor and it will be generally axial tension and/or shear.

**Tension loading** – This is the load applied perpendicular to the surface of the base material and along the axis of an anchor (see Fig. 3.11 a)).

**Shear loading** - This is the load applied perpendicular to the longitudinal axis of the anchor and acting parallel to the concrete surface. The shear loading can be applied with or without a lever arm (Fig. 3.11).

**Shear loading without a lever arm** – The conditions which need to be fulfilled to consider a load acting on anchor without lever arm (Fig. 3.11 b)) are listed in the following:

- The fixture is made of steel and is in contact with the anchor over a length of at least 50% of the thickness of the fixture.
- The fixture is fixed in any of the two ways as described below:
  - either directly to the concrete without an intermediate layer; or
  - using a levelling mortar with a limited thickness (e.g.,  $t_{grout} \leq 0.5d$  under at least the full dimensions of the fixture on a rough concrete surface as intermediate layer. The strength of the mortar shall be at least the same as that of the base concrete but not less than  $30N/mm^2$ ).

**Shear loading with a lever arm** – When the conditions of shear load without a lever arm are not fulfilled, then the shear force on the fastening should be assumed to act with a lever arm. In this case, a bending moment on the anchor will arise (Fig. 3.11 c)).

**Combined tension and shear** – An inclined load (Fig. 3.11 d)) is applied on the fastening and it can be resolved in a tension and a shear component. Anchors must be checked for this combined effect (see [Chapter 6](#) for more details).

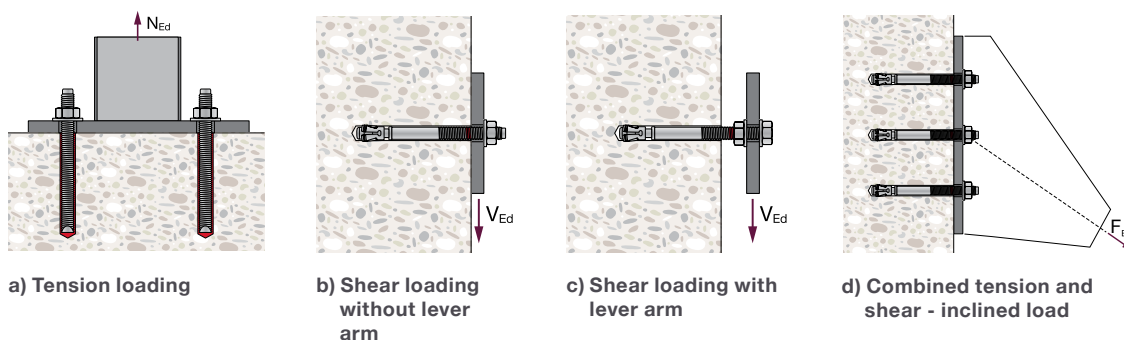

Fig. 3.11: Tension and shear load acting on anchors fastened with attachments to concrete

### 3.5 Types of loading

Loading can be further classified depending on its amplitude over the time. The main loading types are described below:

- **Static loading** refers to any load that is applied slowly to an assembly, object or structure. Static loads usually remain approximately constant in magnitude, direction and location over a longer period of time. A typical example of static load is the self-weight (Fig. 3.12 a)).
- **Quasi-static loading** refers to the application of loads that vary over time. However, the inertial effects are negligible, e.g., variable loads due to the occupancy of the building or wind loads in non-wind-prone low-rising structures. Therefore, these loads are accounted for in design in the same manner as static loads (Fig. 3.12 a)).
- **Cyclic loading** refers to subjecting the anchors to repeated or fluctuating loads over time. Cyclic

loading can occur where applied loads change frequently or when structures experience dynamic forces e.g., wind, earthquakes, machine induced vibrations etc.

- **Alternating cyclic loading** refers to a dynamic loading condition where the applied load changes its direction, an anchor is subjected to loads that fluctuate back and forth over time (Fig. 3.12 b)).
- **Pulsating cyclic loading** is another dynamic loading condition where load fluctuates around a mean value without changing its direction (Fig. 3.12 c)).
- **Seismic loading** refers to the dynamic forces generated by an earthquake. During an earthquake, the ground motion causes structures to move and shake, leading to significant stresses and forces acting on post-installed anchors. The magnitude of seismic loading depends on the horizontal and vertical components of an earthquake’s ground motion and does not follow a periodic pattern. It is typically characterized by a limited number of cycles with high amplitude (Fig. 3.12 e)).
- **Fatigue loading** refers to the repeated application of cyclic loads on the anchors over time. When fatigue loading occurs, a progressive and localized structural damage is caused due to repetitive stress reversals. Fatigue occurs when a structure is subjected to repeated loading and unloading with frequent occurrence and low to medium amplitude (e.g., production machinery, cranes, elevators, traffic on bridges) (Fig. 3.12 d)). The typical number of loads is in the range between  $10^4$  and  $10^8$  cycles.
- **Shock loading** refers to the sudden and intense application of loads, mainly due to sudden impacts or explosions. It creates a rapid increase in force on anchors which can lead to significant stress levels in a short time. Shock loads are transient loads of a very high amplitude and short duration (Fig. 3.12 f)).

The schematic representations of various loadings/actions on structures are shown in Fig. 3.12.

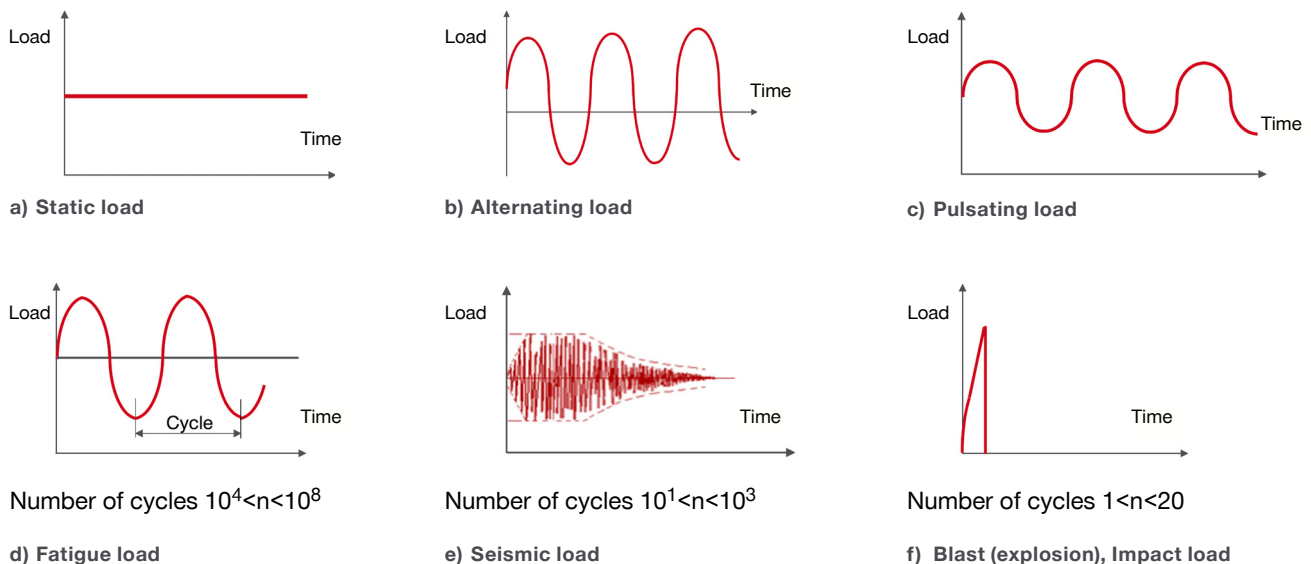

Fig. 3.12: Different loads / actions experienced by anchors

### 3.6 Failure modes of anchors

Anchors can fail in various manner if acting load exceeds their resistance. The failure modes can be distinguished for different loading directions, tension (Fig. 3.13) and shear (Fig. 3.14). Failure modes can further be distinguished between the rupture of the fasteners (steel failure) and the failure of the base material or of the interface between the anchor and base material (concrete failure).

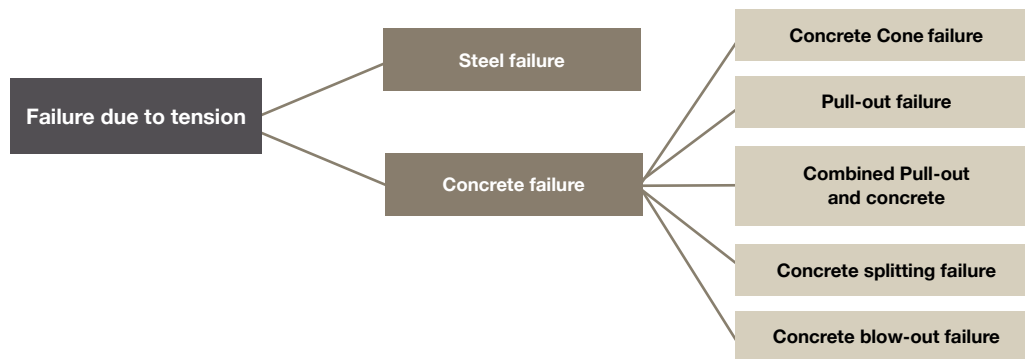

Fig. 3.13: Different types of failures due to tension loading

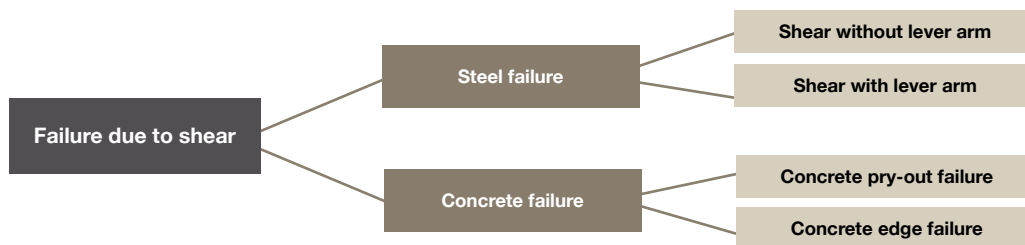

Fig. 3.14: Different types of failures due to shear loading

#### 3.6.1 Failure modes under tension loading

- **Steel failure** occurs when tension stresses induced by the acting load in the smallest cross section of the anchor exceeds the ultimate steel resistance (Fig. 3.15).

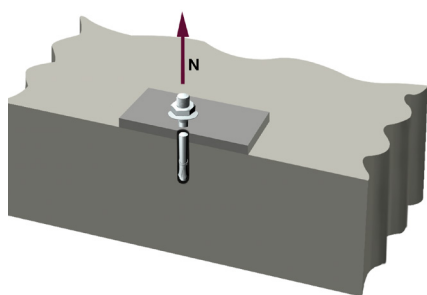

Fig. 3.15: Steel failure under tension loading

- **Concrete cone failure** is characterized by the formation of a cone-shaped fracture surface originating in the load-transfer zone of the anchor and radiating towards the concrete surface with an angle of approx. 35° between the inclined radial crack and concrete surface (Fig. 3.16). The failure mode is also referred as concrete break-out under tension loading.

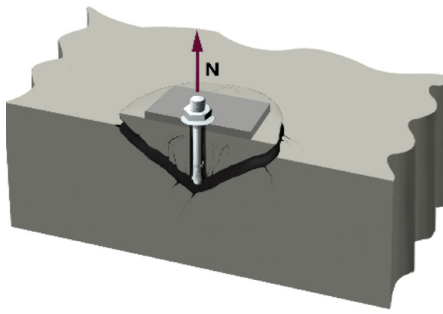

Fig. 3.16: Concrete cone failure under tension loading

- **Pull-out failure** occurs when the entire anchor is pulled out of the drilled hole without significant damage of the base material (Fig. 3.17).

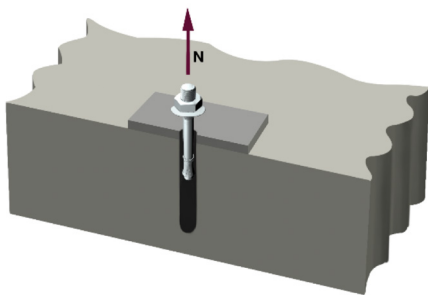

Fig. 3.17: Pull-out failure in tension

- **Combined pull-out and concrete cone failure** is applicable to bonded anchors only. This failure is a combination of the pull-out due to loss of bond between the anchor and the concrete and as a shallow concrete cone close to the concrete surface (Fig. 3.18).

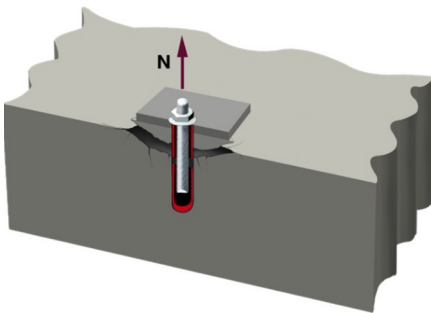

Fig. 3.18: Combined pull-out and concrete cone failure under tension loading

- **Concrete splitting failure** is caused by the hoop stresses around the anchor which originate from local load transfer and expansion forces that exceed the concrete tensile resistance (Fig. 3.19). This failure mode can occur during the installation of an anchor if the minimum spacing, edge distances or member thicknesses are not kept or due to loading in near edge/close to spacing conditions.

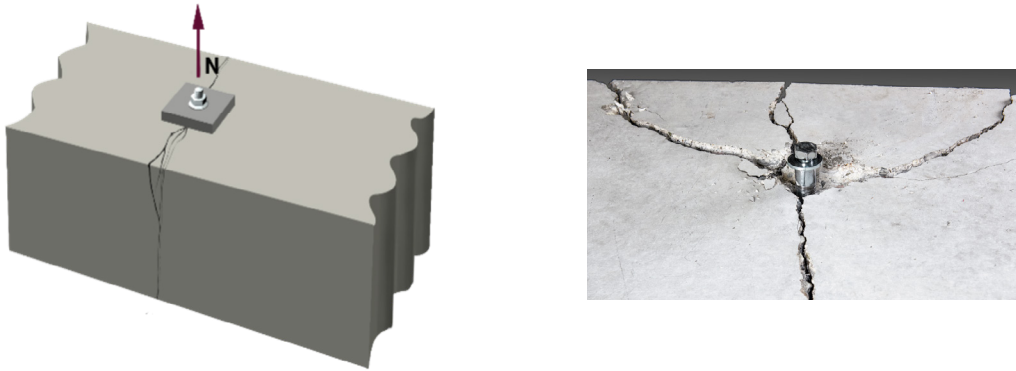

Fig. 3.19: Splitting failure in tension loading

- **Concrete blow-out failure** is a result of high-bearing pressure generated in the load transfer area of the anchor (Fig. 3.20). These high-bearing stresses cause bursting forces transverse to the load direction, creating a concrete break-out on the side face of the member. This failure mode may be decisive in near edge conditions and large embedment that can usually be achieved with headed studs, but usually not with post-installed anchors.

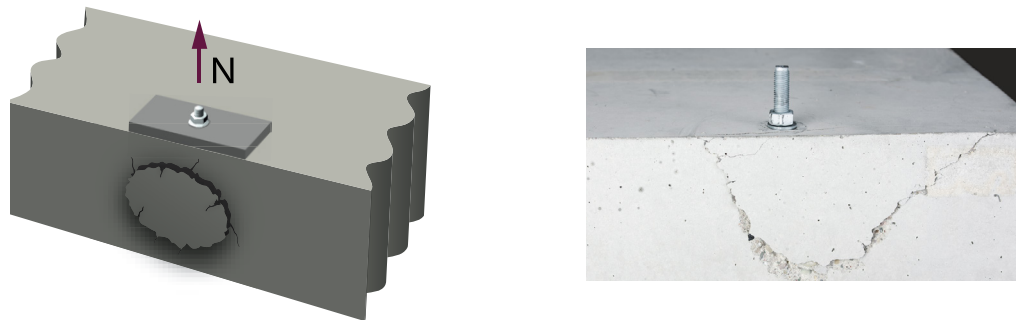

Fig. 3.20: Blow-out failure under tension loading

### 3.6.2 Failure modes under shear loading

The following failure modes due to shear loading can be distinguished.

- **Steel failure** occurs when tension stresses induced by the acting load in the smallest cross section of the anchor exceed the ultimate steel resistance (Fig. 3.21). If the shear load is applied with a lever arm the resistance is reduced due to the additional tensile stress arising from the caused bending moment.



a) Failure without lever arm



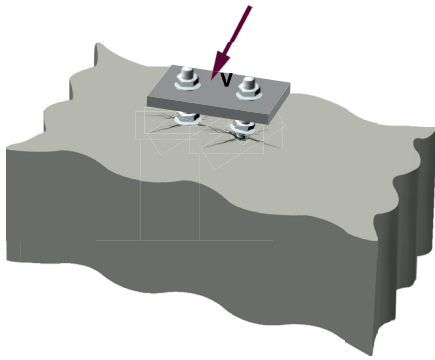

b) Failure with lever arm

Fig. 3.21: Steel failure under shear loading

- **Concrete pry-out failure** primarily occurs in cases of limited embedment depth of anchors. It is caused by rotation of the fastener and the catenary tension force generated in the anchor bolt as a result of lateral deformation and the eccentricity between the acting shear force and the resultant resisting force in the concrete (Fig. 3.22).

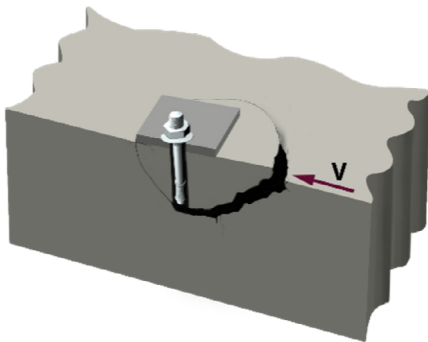

Fig. 3.22: Concrete pry-out failure under shear loading

- **Concrete edge failure** occurs under shear load when the anchors are close to an edge in the loading direction. It is characterized by the formation of a cone shaped fracture surface originating at the anchor shaft and radiating towards the concrete edge with an angle of approx. 35° (Fig. 3.23). This failure mode is also referred as concrete break-out under shear loading.

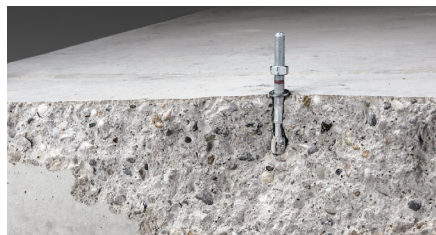
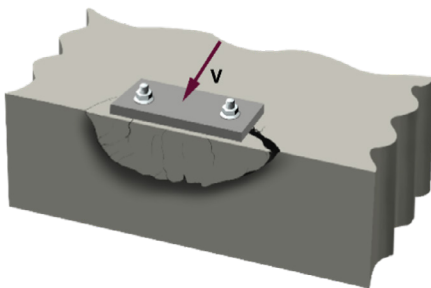

Fig. 3.23: Concrete edge failure under shear loading

### 3.7 Factors influencing the performance of anchors

The load-displacement behavior of anchors is significantly influenced by several parameters such as: base material, installation, environmental conditions and loading types. Research over the last 40+ years has highlighted the main factors. This has helped to lay down the foundation of prequalification criteria

**Note:** See [Chapter 4](#) for assessment and qualification of anchors.

of anchors (see [Section 4.4](#)). In the following some of the main influencing factors are described.

### 3.7.1 Base material

In this handbook the only considered base material is **normal weight concrete**. Anchors rely on the tensile strength of concrete (Fig. 3.1). The concrete strength classes influence to different extents the various concrete-related failure modes under tension and shear loading. As well-known from the design and construction of reinforced concrete structures, the tensile strength of any concrete grade is significantly lower than the compressive strength (approx. 1/10). Therefore, concrete is likely to be subjected to cracking when under tension loading (e.g., the tension zone of a cross section subjected to bending). **The load-carrying behavior of a fastener is negatively influenced by concrete cracking.** The level of influence is strictly related to the load-carrying mechanism of a specific fastener type (see [Section 3.1](#)). Fig. 3.24 c) shows a typical load-displacement behavior in cracked or uncracked concrete under tension loading. In uncracked concrete, the displacement is much less than in cracked concrete and load capacity is higher. An extensive analysis on the behavior of fasteners in cracked vs. uncracked concrete is documented by Eligehausen et.al. ([2]).

Widening of a crack passing through the anchor location reduces expansion force and consequently the friction mechanism of metal expansion fasteners. If an anchor does not expand fully, displacement increases and load-carrying capacity decreases. We usually distinguish between systems that exhibit a follow-up expansion when concrete cracks (suitable for use in cracked concrete) and systems that do not (not suitable for use in cracked concrete). In the case of undercut anchors, the bearing surface decreases, while for bonded anchors the bond along a portion of the lateral surface is not effective anymore (Fig. 3.24 a)).

**Note:** For more details about performance of anchors (EC2-4 [1] and other guidelines) see [Chapter 6](#).

The presence of cracks in concrete within the serviceability limit state (width of crack  $\approx 0.3$  mm) reduces the resistance against concrete cone failure by up to 30%. When concrete is expected to be subjected to cracking, the radial stresses in the concrete are bisected by the crack (Fig. 3.24 b)). This explains the reduced load-carrying resistance. In the case of pull-out, the strength reduction in cracked concrete is product dependent and needs to be assessed with pre-qualification tests.

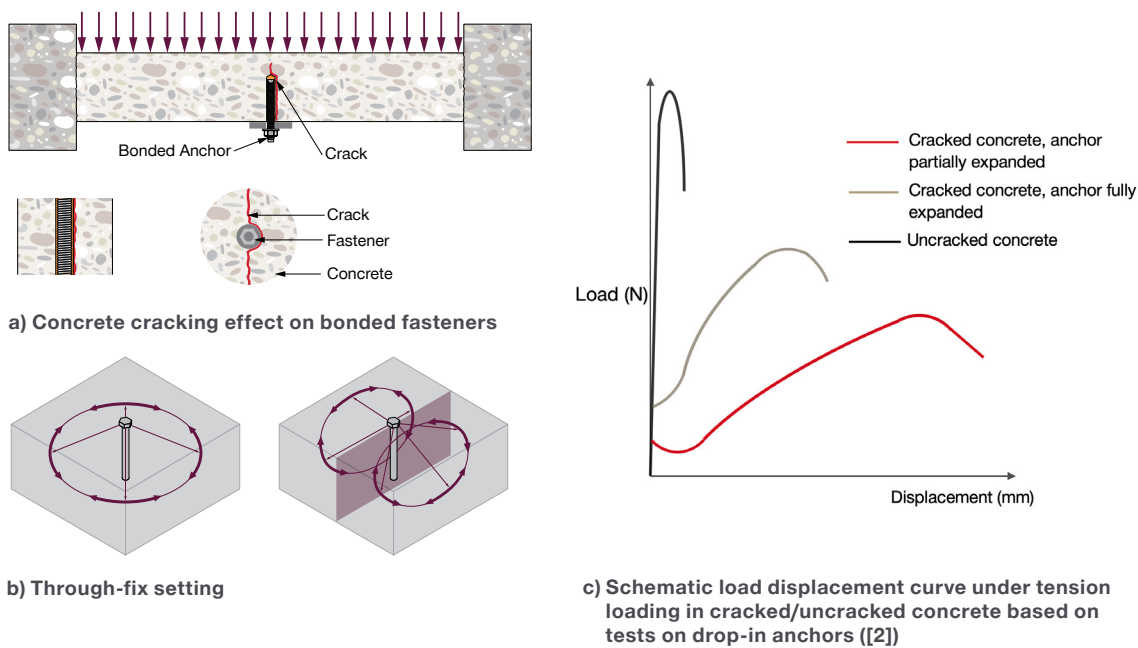

Fig. 3.24: Distribution of forces in uncracked and cracked concrete

### 3.7.2 Installation

Correct installation is essential to achieve the desired performance of fasteners and must follow the installation instruction of a specific anchor product. Detailed installation methods, equipment and the tools required are described in [Chapter 8](#). In this section, some key aspects which can influence performance of anchors are discussed. Some relevant parameters are described below:

- Drilling:** different drilling techniques are available (e.g., hammer drilling and diamond coring) that produce holes with a lateral surface of different roughness levels (see [Section 8.3.2](#)). Fastener types that rely on bond or friction as the load-carrying mechanism may be very sensitive to the adopted drilling method (Fig. 3.25). The drilling diameter must be chosen according to the instructions provided by the fastener's manufacturer. Bonded anchors are installed in oversized drilled holes to allow a mortar layer between concrete and the steel element. Their performance is not necessarily impacted by slightly larger boreholes. However, oversized holes may significantly reduce the load-carrying capacity of mechanical anchors. There is a chance that an expansion sleeve will not engage the hole wall sufficiently. Performance of screw anchors depends on the tolerance of a drilled hole to realize a sufficient undercut with the thread.
- Hole cleaning:** the degree of hole cleaning has great influence on the bond strength of chemical anchors. Therefore, the drilled hole should be thoroughly cleaned to remove dust in order to ensure the designed tension resistance. Uncleaned/improperly cleaned drilled holes can lead to tension failure load reductions of 60% or more for injection-type bonded anchors. The load-displacement behavior of bonded fasteners with respect to hole cleaning is qualitatively shown in Fig. 3.26.

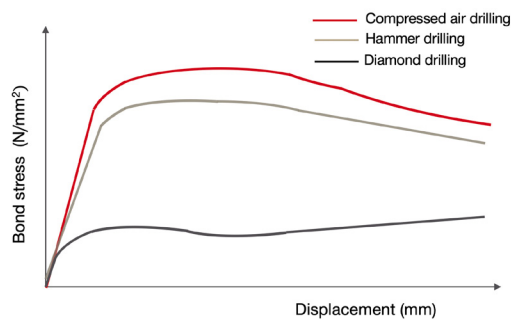

Fig. 3.25: Bond stress-displacement graph for bonded anchors in cleaned holes with hammer and diamond drilling ([2]), example of a system not suitable for diamond coring.

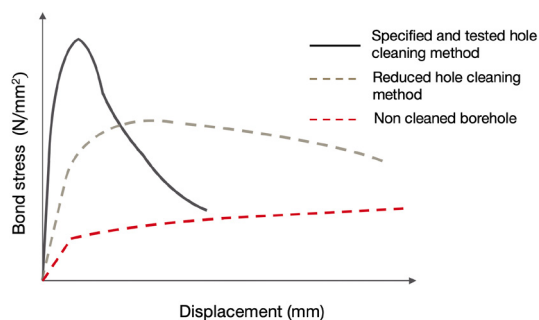

Fig. 3.26: Load displacement curve for well-cleaned / uncleaned holes in cracked concrete ([2])

- Setting of anchors:** the necessary torque should be applied to ensure a proper installation for some fastener types such as screw and bonded anchors. It is important to apply adequate torque to secure the anchors in position and minimize the displacements between anchors and base material at service loads (Fig. 3.7 and Fig. 3.8). For torque-controlled expansion anchors, the application of the recommended torque is necessary to activate the load-carrying mechanism (see Fig. 3.4). The torque is replaced by the energy required to install the bolt in the right position in respect to the sleeve for displacement controlled expansion and undercut anchors (see Fig. 3.5 and Fig. 3.6). Not applying the right torque, exceeding it, or not using the setting tools recommended by the manufacturer will lead to a faulty installation and poor load-displacement behavior of the fastener (see Fig. 3.24). For bonded anchors, the adequate bond for proper placement is required to be developed to ensure the desired performance.

### 3.7.3 Environmental conditions

Environmental conditions have an impact on anchors' resistance. For exterior applications, anchors can be exposed to variations in moisture content and temperature fluctuations. These have a particular influence on the resistance of bonded anchors.

- **The temperature of base material** is very important at installation as well as in service. The curing time of bonded anchors increases with increasing temperature [2]. Not keeping to the minimum curing time prevents the bonding material from reaching full strength. Curing time varies with the type of mortar/chemical used. During service life the bond strength of bonded anchors depends on the temperature of base material. The strength decreases with an increase in temperature (refer to Fig. 3.28). Also, the displacement of anchors is dependent on temperature.
- **Freeze and thaw cycles:** displacements of anchors gradually increase as they are exposed to a growing number of freeze and thaw cycles (see Fig. 3.27). Freeze and thaw cycles have an impact on anchors because they can cause expansion or contraction of materials (steel anchor rod, chemical and concrete) affecting the anchor's grip and stability over time.

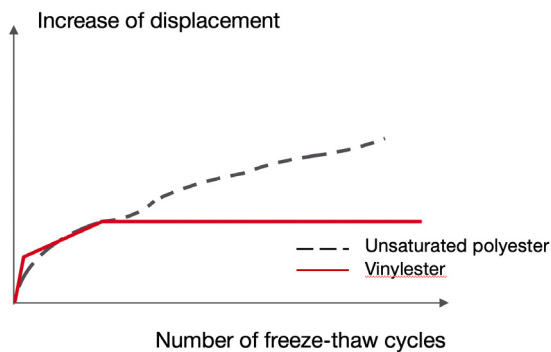

Fig. 3.27: Influence of freeze-thaw cycles on the displacement of bonded anchors ([2])

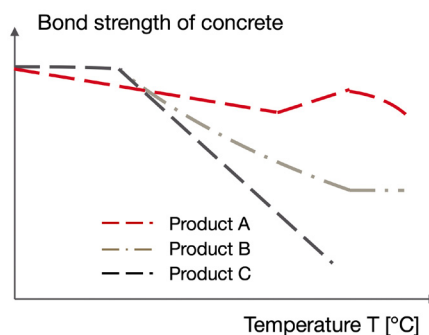

Fig. 3.28: Influence of temperature on bond strength ([3])

- **Durability/corrosion protection:** it is necessary to provide proper corrosion protection to anchors for different applications. In some cases, zinc electro-galvanizing is not a preferable solution, such as in inadequately ventilated façade applications. In permanently damp, or poorly ventilated narrow spaces, the use of stainless steel anchors is recommended. Usually, any corrosion protection will deteriorate over time. Therefore, the right choice is linked also to the design's working life (e.g., 50 or 100 years for bonded anchors). For more details refer to [Section 5.1](#) and [2].

### 3.7.4 Loading types

Different loading directions and types that anchors can experience are described in [Sections 3.4](#) and [3.5](#). To each specific loading type various influencing factors can affect the load-displacement behavior of fasteners. Some of them are discussed in this section.

**Sustained load:** anchors are designed to carry loads over many years. If a tension load is constant for long period of time, creep effects may occur. This is particularly relevant for bonded anchors (Fig. 3.29). For this type of anchor, displacement increases under sustained load. When the adhesion displacement is exceeded, a failure is likely to occur. The influence of sustained load on bond strength is dependent on the temperature of concrete during design life.

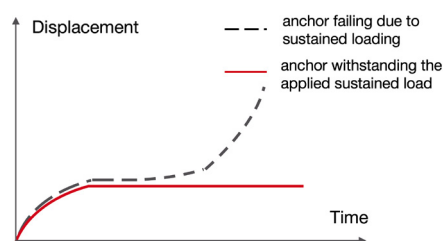

Fig. 3.29: Effect of sustained tension loading on displacement behavior

**Seismic loading:** anchors under seismic loading are usually subjected to cyclic loading with significant amplitude and base material is supposed to be cracked beyond the serviceability limit state (i.e.  $> 0.3 \text{ mm}$ ) due to the potential significant deformations. These conditions must be considered in the prequalification and design of anchors. Fig. 3.30 schematically shows how the ground accelerations induce deformations in a structure and the transfer of seismic actions to anchors connecting structural and non-structural elements. This results in high-rate cyclic loading and cracks of changing width.

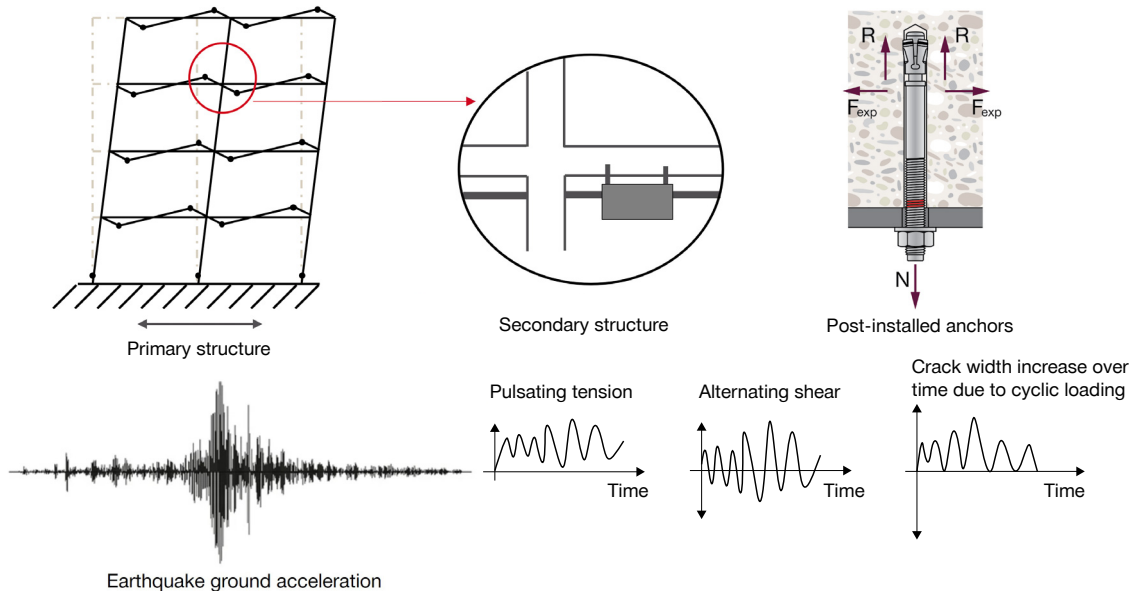

Fig. 3.30: Seismic design of post-installed connections

Over the last 20+ years significant research has been conducted to understand the conditions that need to be resisted by anchors to safely carry loads during a seismic event. Hoehler (2006) [4] investigated the effect of cyclic loading and loading rate on the different failure modes under tension and also identified as  $0.8 \text{ mm}$  the maximum crack width to be expected in flexural systems outside of plastic hinges. The results of mainly analytical studies also confirm the behavior of experimental anchors installed in shear wall by Faraone et al. (2022) [5]. The research discussed in [4] also highlighted that the effect of the loading rate can be conservatively neglected, because it has a positive or no effect on the resistances against different failure modes. At the same time, it was shown that the performance of anchors in cracks that change in amplitude during the simulated seismic event is critical. Later research has contributed to defining loading protocols for the pre-qualification of post-installed anchors under tension and shear loading ([6] and [7]). Only limited investigations were available to understand the effect of seismic combined tension and shear actions [8].

**Fatigue loading:** a high number of loading cycles during a fastening's working life (usually more than 1000) can negatively affect its steel resistance as well as the base material (refer to [Section 6.12](#)). If a material is subjected to a cyclic loading over the time, it can fail after a certain number of load cycles, even though the upper limit of the load withstood up to this time is clearly lower than the ultimate tensile strength under static loading. This loss of strength is referred to as material fatigue. It corresponds to the maximum load amplitude that can be withstood for a given number of load cycles. If a level of stress can be determined at which failure no longer occurs after any number of load cycles, reference is made to fatigue strength. Higher loads can often only be withstood for a smaller number of cycles. Over the past decades, several researchers investigated the effect of fatigue loading on different anchor failure modes such as steel failure (e.g., [9], [10]), pull-out (e.g., [11]) and concrete cone breakout (e.g., [12]).

**Fire exposure:** under fire exposure, properties of anchors and base material decay with increasing temperature. Anchors need to be qualified for such conditions (refer to [Section 6.11](#)). The loss of strength of anchors depends mainly on the fire duration embedment depth and failure mode. Reick (2001) [14]

**Note:** Current research is mainly valid for standard time-temperature curve as per ISO 834-1 [13].

characterized the steel stress at failure during fire as a function of the fire duration and the type of steel (stainless or galvanized). Reick (2001) also developed concrete break-out equations for fire exposure of up to 120 Minutes. More recently, the behavior of bonded anchors in respect to combined concrete cone and pull-out failure was investigated by means of experimental and numerical methods ([15], [16]). The behavior of metal expansion anchors has been investigated by K. Bergmeister and A. Rieder [17], highlighting a larger decrease in residual load capacity than bonded anchors.

## 4. REGULATORY FRAMEWORK FOR QUALIFICATION AND DESIGN

### 4.1 Overview of European regulatory framework

Post-installed fastenings in concrete can be designed following the provision of Eurocode 2 part 4 (EC2-4) [1] (see Fig. 4.2). We will discuss the details of EC2-4 [1] in [Chapter 6](#). The development of these provisions over the last decades until the publication of EC2-4 [1] schematically shown in Fig. 4.1. The scope of post-installed anchors has been gradually introduced in Europe, starting from a local guideline issued in the 1990s. During 1989-1997, the design transitioned from the so-called **Kappa method (K)** to the **Concrete Capacity method (CCD)**. In 1997, the European Organization of Technical Assessment (EOTA) developed the first guideline for qualification of fastenings: the ETAG 001 [18]. Design of mechanical anchors is given in Annex C. Only in 2019 this guideline became part of the EC2-4 [1]. The design of bonded anchors was introduced in EOTA Technical Report (TR) 029 [19] and now it is also part of the EC2-4 [1].

**Note:** Eurocodes shall be referred as follows throughout this handbook, i.e., EN 1992-4 as EC2-4.

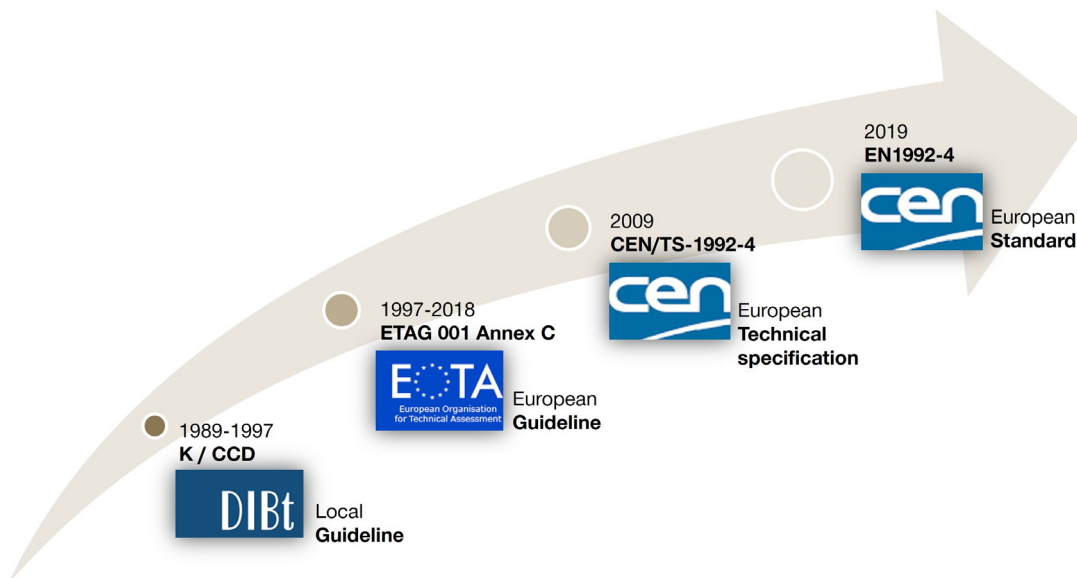

**Note:** K method is based on simple engineering models supported by regression analyses.

**Note:** CCD method calculates load bearing capacities for different load cases and anchor configurations.

Fig. 4.1: Timeline for inclusion of post-installed fastenings in Eurocode

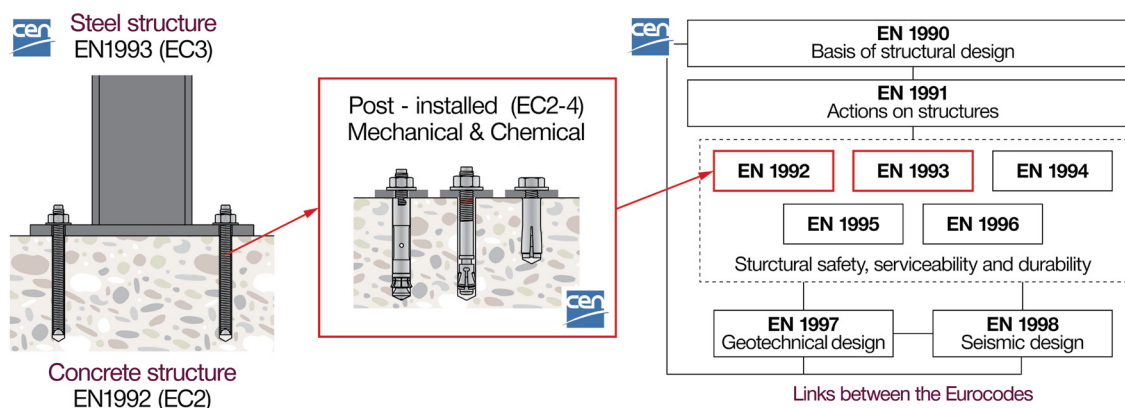

Fig. 4.2: Links between the Eurocodes and the focus on EC2-4 for post-installed anchors

The **European Committee for Standardization (CEN)** provides the platform for the development of European codes, standards and other technical documents in relation to various kinds of products, materials, services and processes. **Eurocodes (EC)** and standards which are published by CEN serve as

reference documents to design and build, prove compliance and specify contracts of building and civil engineering works. They cover the main aspects and principles of structural design for all actions and resistances. Details are shown in Fig. 4.3.

**Note:** The Eurocodes are enforced in the CEN member states jointly with applicable national regulations (e.g., national annexes to single Eurocodes).

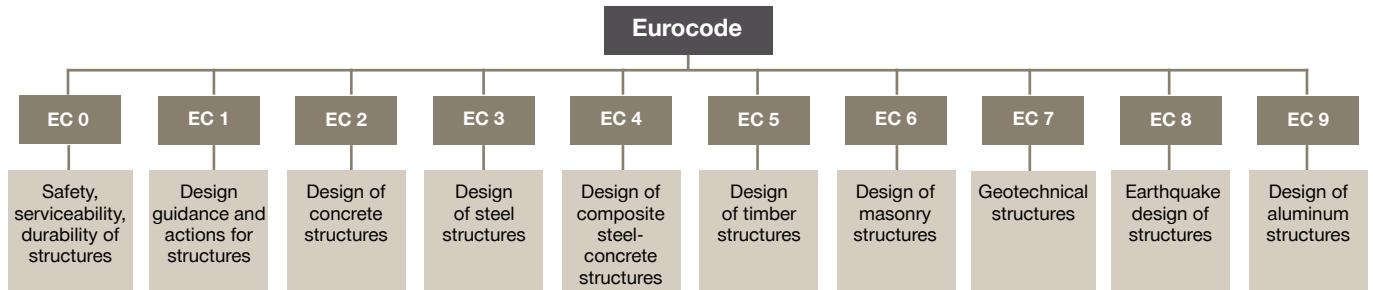

Fig. 4.3: Eurocodes and their scope

The performance assessment of post-installed anchors is regulated by **European Assessment Documents (EADs)** developed by the **European Organisation for Technical Assessment (EOTA)**, which comprises all Technical Assessment Bodies (TABs) designated by member states of the European Union and the European Economic Area (e.g., DIBt in Germany, CSTB in France, ITC-CNR in Italy etc.). EADs deal with preconditions, assumptions, required tests, assessments of essential performance characteristics and their qualification criteria. The assessed construction systems according to a particular EAD are published in **European Technical Assessments (ETAs)**, issued by TABs. ETAs showcase the assessed performance characteristics of products and their evaluated installation methods.

**Note:** Only anchors with a CE-Mark referring to the correct ETA and EAD should be used in safety relevant applications.



EOTA coordinates the application of the procedures set out for the request of an ETA and for adopting an EAD. Also, in addition and supplementary to the European codes and standards, **EOTA Technical reports (TR)** are developed as supporting documents to EADs. These contain detailed aspects relevant to construction products such as execution and the evaluation of tests. The overall high-level function of the European Regulatory Framework is depicted in Fig. 4.4.

**Note:** EOTA is in charge of the assessment of construction products (in case there is no harmonized EN). Design is addressed by CEN. However, if no design exists for a construction product and its intended use, EOTA also provides design documents (typically issued as TRs). These design documents should not be in contradiction or conflict with CEN design documents.

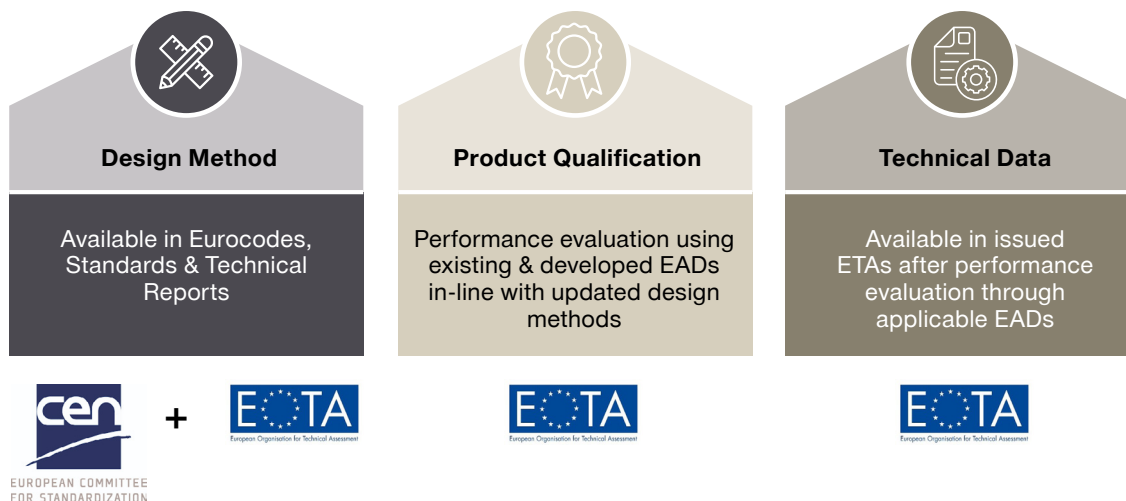

Fig. 4.4: European framework for design and assessment of post-installed fastening solutions





## 4.2 Design and qualification of post-installed anchors

From the framework shown in Fig. 4.4, design and assessment are covered in different European standards and EOTA EADs. Design regulation is primarily guided by CEN standards, e.g., EC2-4 [1] and, in some cases, EOTA TRs. Assessment requires testing of post-installed anchors under various influencing conditions, dictated as per the corresponding EAD. The technical data are published in the ETA.

EC2-4 [1] provides the design method for post-installed fastenings which transfer load to concrete. This includes all different modes of failure in tension and shear, as described in Section 3.6. The design utilizes the characteristic resistances and other product-specific characteristics (e.g., minimum edge distances, spacings and pull-out/bond resistances) from the relevant ETA. The design of the baseplate is addressed in other standards applicable for design of steel structures (e.g., EC3-1-8 [20]). The product performance depends on assessment according to EAD 330232 [21] for mechanical anchors, EAD 330499 [22] for bonded and bonded expansion anchors and EAD 332795 [23] for bonded screw anchors. Table 4.1 summarizes different assessment and design methods for various types of post-installed anchors:

Table 4.1: Design and qualification documents for post-installed anchors

	Mechanical	Chemical	Bonded screw
			
<b>Qualification</b>	Static, Seismic, Fire: <b>EAD 330232</b> Fatigue: <b>EAD 330250</b>	Static, Seismic, Fire 100 years: <b>EAD 330499</b> Fatigue: <b>EAD 330250</b>	Static, Seismic: <b>EAD 332795</b> Fatigue, Fire: Not covered
<b>Design</b>	Static and Seismic: <b>EN 1992-4</b> , Fatigue: <b>EN 1992-4</b> or <b>EOTA TR 061</b> Fire: <b>EN 1992-4</b>	Static and Seismic: <b>EN 1992-4</b> , Fatigue: <b>EN 1992-4</b> or <b>EOTA TR 061</b> Fire: <b>EN 1992-4</b> and <b>EOTA TR 082</b>	Static and Seismic: <b>EOTA/TR 075</b> Fatigue, Fire: Not covered

The evolution of post-installed anchors: design methods and assessment over the last two decades are depicted below in Fig. 4.5 and Fig. 4.6, respectively.

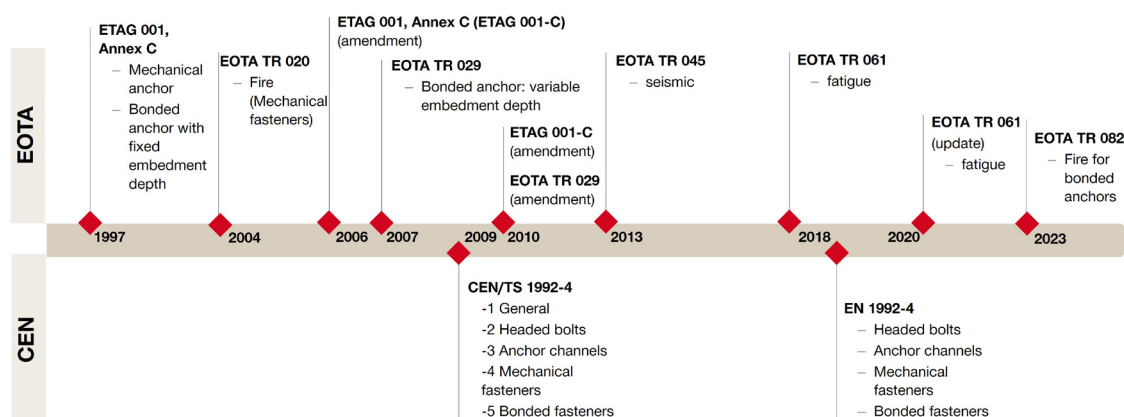

Fig. 4.5: Evolution of design methods since 1997

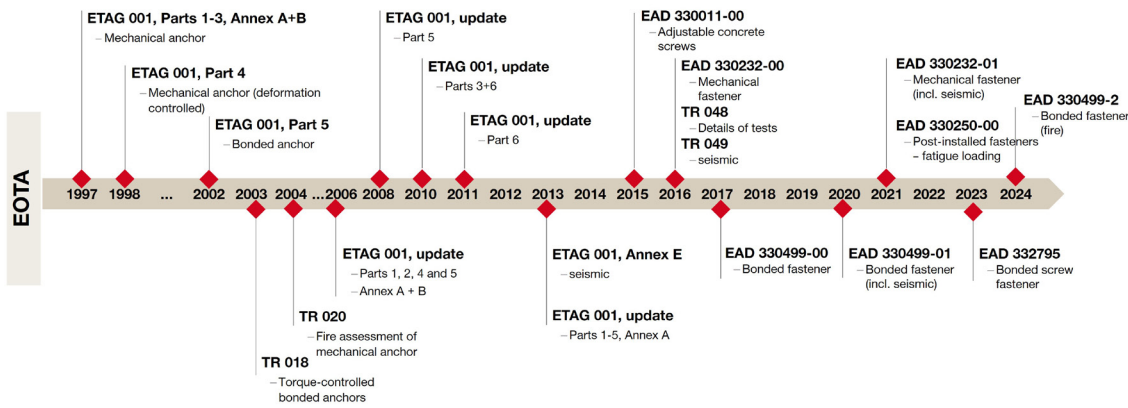

Fig. 4.6: Evolution of qualification guidelines since 1997

## 4.3 Design of post-installed anchors

### 4.3.1 Design and applications covered by EC2-4

EC2-4 [1] includes provisions for design criteria for post-installed anchors. The main scope of EC2-4 [1] is summarized in the following:

**Note:** EC2-4 covers design under static, seismic and fatigue actions as well as under fire exposure.

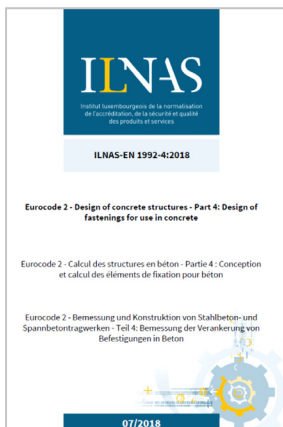

- Design of post-installed mechanical anchors such as expansion fasteners, undercut fasteners and concrete screws.
- Design of post-installed bonded and bonded expansion anchors.
- Normal weight concrete as base material.
- It allows design of both single and group of fasteners.
- Design of anchors for static, seismic and fatigue loading. The design under fire exposure of mechanical anchors is also covered.
- Requirements of durability and the performance categories of anchors.
- Verification of concrete element due to loads applied by fastenings.

### 4.3.2 Design of anchors under fatigue loading (EOTA TR 061)

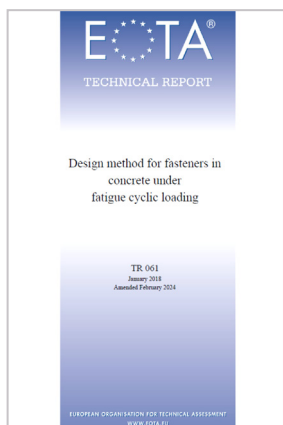

- EOTA TR 061 [24] amends the scope of EC2-4 [1] including additional design methods that account for realistic loading conditions, such as the expected number of load cycles and the portions of static and fatigue actions.
- The scope covers the design of post-installed anchors assessed based on EAD 330250 [25] under tension, shear and a combination of both for fatigue cycle loading.

**Note:** Detailed design provision for fatigue is described in [Section 6.12](#).

### 4.3.3 Design of bonded screw anchors (EOTA TR 075)

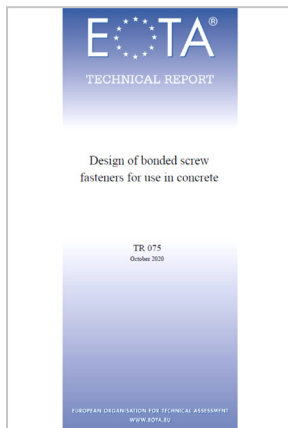

- This provides an amendment to EC2-4 [1] for design of concrete screws in combination with bonding material. The main difference consists of considering the combination of the resistance contributions of the concrete screw and of the bonding material under tension loading.

### 4.3.4 Design of bonded anchors under fire exposure (EOTA TR 082)

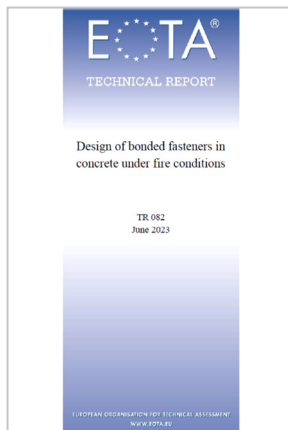

- This technical report covers design of bonded anchors for fire exposure under tension, shear and combined actions.
- It refers to the design method of EC2-4 [1] for all failure modes with the addition of combined pull-out and concrete failure for tension loading.
- It includes two types of analysis methods:
  - Simplified method:** it considers the highest temperature profile along the embedment depth for calculating combined pull-out and concrete cone resistance.
  - Resistance integration method:** it considers the temperature profile along the embedment depth in a more detailed way.
- Recommended temperature profiles for a single anchor exposed to fire are given as a third-degree polynomial relationship between the temperature of fastener and its position along the embedment depth. The data is available for fire exposure of 30, 60, 90 and 120 minutes.

**Note:** Detailed design provision for fire is described in [Section 6.11.2](#).

## 4.4 Qualification of post-installed anchors

The qualification of post-installed anchors refers to the process of evaluating performance and suitability for a specific application. The qualification of anchors depends on multiple steps/processes: manufacturer's documentation, third-party testing, quality control and environmental considerations. The essential characteristics of the product are included in an ETA and used in the design as per EC2-4 [1] or applicable EOTA TR. The qualification of post-installed anchors described in this book is based on EOTA EADs.

### 4.4.1 Qualification of mechanical anchors as per EAD 330232

EAD 330232 [21] covers post-installed mechanical metal anchors placed into pre-drilled holes perpendicular to the surface in concrete and anchored therein by mechanical means such as friction or mechanical interlock.

This EAD covers assessment of torque controlled and deformation-controlled expansion fasteners,

undercut fasteners, and concrete screws. The characteristic resistances against the relevant failure modes in tension and shear are derived. It covers testing and assessment under the following key requirements (Table 4.2):

Table 4.2: Different parameters covered in EAD 330232 [21]

Parameter	Description
Minimum thread diameter	6 mm (5 mm for dry internal exposure and statically indeterminate structure)
Minimum embedment depth	40 mm (30 mm for dry internal exposure and statically indeterminate structure)
Installation temperature	-40°C to +80°C
Design working life	50 and 100 years
Base material	Concrete strength C20/25 – C50/60
	Uncracked and cracked concrete
	Influence of steel fibers
Sensitivity to installation conditions	Drilling method
	Drill bit tolerances
	Over- and under-torquing
	Minimum edge distance and spacing
Environmental conditions	Hydrogen embrittlement (for screw fasteners only)
Loading types	Seismic category C1 and C2
	Fire exposure up to 120 minutes
Corrosion protection	Assessment of different steel types and/or coatings
Characteristic displacements	Values for short and long-term loadings

#### 4.4.2 Qualification of bonded and bonded expansion anchors as per EAD 330499

EAD 330499 [22] covers assessment of bonded and bonded expansion anchors. The bonding material and embedded metal part are placed in pre-drilled holes and anchoring is done primarily by bond. The metal part can be a threaded rod, deformed reinforcing bar, internal threaded sleeve or other shape made of carbon steel, stainless steel or malleable cast iron.

In this EAD, bonded anchors are distinguished according to the operating principles, mixing and installation techniques and other information related to installation, such as the type of bonding material (organic/inorganic), drilling technique etc.

The characteristic resistances against the relevant failure modes in tension and shear are derived with particular focus on bond strength. The EAD 330499 [22] covers testing and assessment under the following key requirements (Table 4.3):

**Note:** Refer to product relevant ETA for characteristic resistance values which are used in design, see details in [Section 6.6](#) to [Section 6.12](#).

Table 4.3: Different parameters covered in EAD 330499 [22]

Parameter	Description
Minimum thread diameter	6 mm
Minimum and maximum embedment depth	$\geq 40$ mm and $\geq 4d_i$ and $\leq 20d_i$
Installation temperature	-40°C to +40°C
Design working life	50 and 100 years
Base material	Concrete strength C12/15 – C90/105
	Uncracked and cracked concrete
	Influence of steel fibers
Sensitivity to installation conditions	Drilling method
	Drill hole cleaning
	Installation direction (vertical downward/upward and horizontal)
	Minimum edge distance and spacing
	Minimum curing time
Environmental conditions	Freeze and thaw cycles
	High alkalinity and sulfurous atmosphere
	In-service temperature
Loading types	Sustained load
	Seismic category C1 and C2
	Fire exposure up to 120 minutes
Corrosion protection	Assessment of different steel types and/or coatings
Characteristic displacements	Values for short- and long-term loadings

#### 4.4.3 Qualification of mechanical and bonded anchors as per EAD 330250

The EAD 330250 [25] covers both mechanical and bonded post-installed anchors for fatigue tension and shear loading. The anchors are usually required to be secured by turning nuts to avoid any kind of loosening during fatigue loading. Under fatigue shear loading, an annular gap between the anchor and hole in a fixture is not allowed. There are three methods to assess the performance of anchors under fatigue loading as described in Table 4.4 and Fig. 4.7.

Table 4.4: Different methods given in EAD for fatigue qualification

Method	Features
<b>Method A</b>	<ul style="list-style-type: none"> <li>Resistance given as continuous function depending on number of cycles</li> <li>Experimental derivation based on at least 9 assessment points</li> <li>Design method I and II according to EOTA TR 061 [24] (see <a href="#">Section 6.12</a> and Fig. 4.7 a) for more details).</li> </ul>
<b>Method B</b>	<ul style="list-style-type: none"> <li>Only fatigue limit resistance is derived (endurance level for infinite number of cycles)</li> <li>Design method II according to EOTA TR 061 [24] (see <a href="#">Section 6.12</a> and Fig. 4.7 b) for more details).</li> </ul>
<b>Method C</b>	<ul style="list-style-type: none"> <li>Linearized function of the fatigue resistance depending on number of cycles</li> <li>Experimental derivation based on at least 4 assessment points</li> <li>Simplification of method A</li> <li>Only bonded and torque-controlled expansion anchors are covered</li> <li>Design method I and II according to EOTA TR 061 [24] (see <a href="#">Section 6.12</a> and Fig. 4.7 c) for more details).</li> </ul>

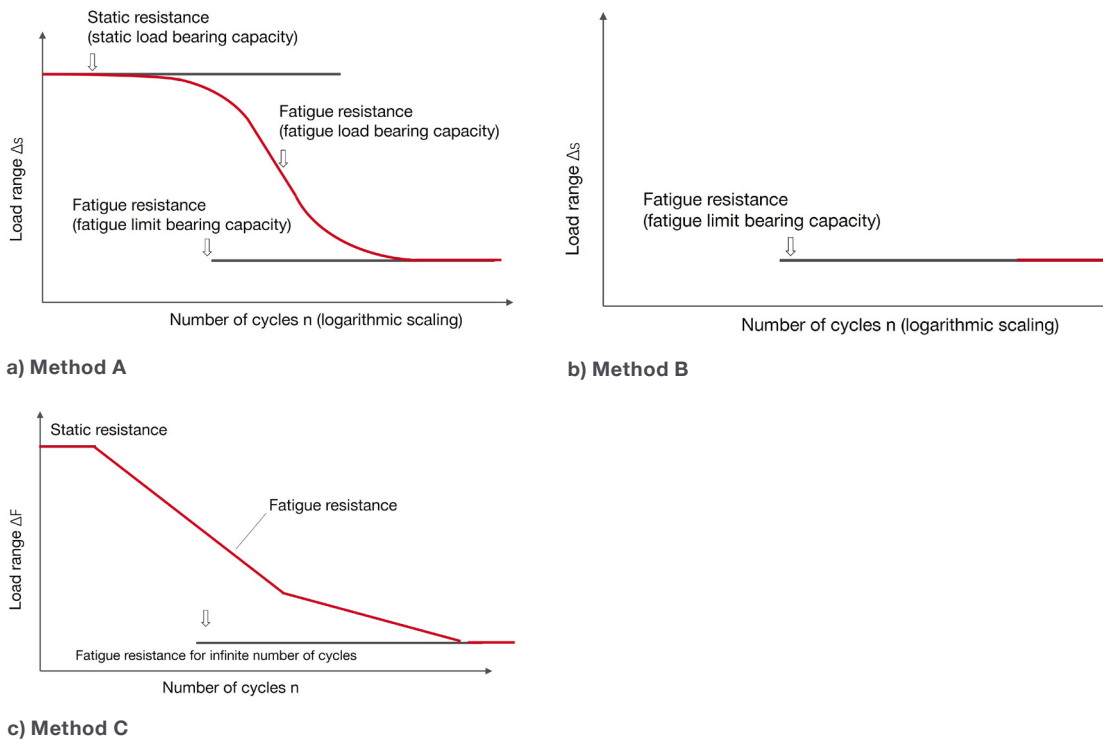

Fig. 4.7: Different assessment methods (graphical representation)

#### 4.4.4 Qualification of bonded screw anchors as per EAD 332795

The EAD 332795 [23] covers assessment of post-installed bonded screw anchors. The qualification criteria for a bonded screw anchor considers robustness aspects relevant for mechanical and bonded anchors. The performance is based on the concrete screw and mortar combination.

The bonded screw anchor may neither be assessed according to EAD 330499 [22] because the external thread diameter of the steel element is larger than the drill hole diameter, nor according to EAD 330232 [21] because some essential characteristics are different (e.g., combined pull-out and

concrete failure, influence of sustained load,  $\psi_{sus}^0$ ). EAD 332795 [23] covers the following in its scope (Table 4.5):

Table 4.5: Different parameters covered in EAD 332795 [23]

Parameter	Description
Minimum diameter	6 mm
Minimum and maximum embedment depth	$\geq 40$ mm and $\leq 8d_o$
Installation temperature	-40°C to +40°C
Design working life	50 years
Base material	Concrete strength C20/25 to C50/60
	Uncracked and cracked concrete
Sensitivity to installation conditions	Drilling method
	Drill hole cleaning
	Installation direction (vertical downward/upward and horizontal)
	Minimum edge distance and spacing
	Minimum curing time
Environmental conditions	Freeze and thaw cycles
	In-service temperature
	High alkalinity and sulfurous atmosphere
	Hydrogen embrittlement
Loading types	Sustained load
	Seismic category C1 and C2
Characteristic displacements	Values for short- and long-term loadings

## 5. HILTI SOLUTIONS

### 5.1 Criteria for selecting an anchor type

The main criteria for selecting the right post-installed anchors depend on various factors as defined in Fig. 5.1.

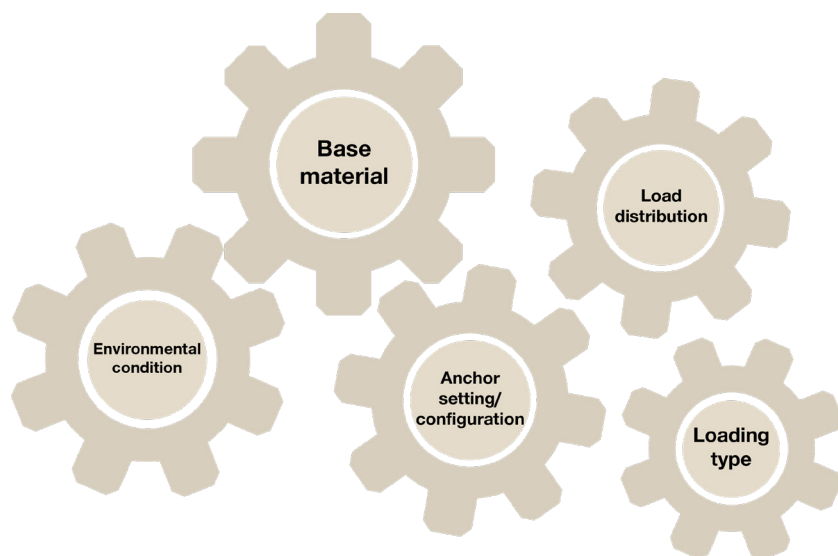

Fig. 5.1: Basic criteria for anchor selection

#### 5.1.1 Base material as concrete and its properties

The wide variety of building materials used today provide different anchoring conditions. The properties of the base material play a decisive role when selecting a suitable anchor and determining the load it can hold. In this handbook only normal concrete is considered as a base material. The tensile capacity of concrete is utilized by the anchor to transfer the loads. The capacity of the fastener will be negatively impacted if the compaction of concrete is not done properly.

**Note:** The concrete may be assumed to be uncracked or cracked. This assumption has a significant impact on the design output.

The concrete referred to in this handbook for post-installed fastening systems should be designed, detailed, planned, produced, transported, placed, compacted, cured and tested according to the requirements of applicable Eurocodes and standards. The concrete material should also satisfy the following requirements:

- 1) Normal weight concrete (without fibers) of strength as applicable in EAD and design standard conforming to EN 206 [26].
- 2) Unreinforced normal weight concrete shall have minimum detailing requirements as per EC2-1-1 [27] when used for structural purposes.
- 3) The concrete shall be non-carbonated.
- 4) The maximum allowed chloride content in the concrete for intended use according to EN 206 [26] Table 15 is Cl 0.20 or 0.40% (related to cement content) depending on the product ETA.

**Note:** See Hilti whitepaper on fastening SFRC for more details.

The thickness of base material is also an important parameter to be checked for the correct selection of anchors. This is because the suitability varies for different types.

**Note:** Anchors can be installed in Steel Fibre Reinforced Concrete (SFRC) with fibers according to EN 14889-1 [59] added to the concrete matrix, if they have been assessed according to the EAD 330232 [21] or EAD 330499 [22]. This assessment does not allow to account for a potential beneficial effect of the SFRC on the anchor performance.





### 5.1.2 Anchor setting and configurations

Other considerations in anchor selection include how close the anchors will be placed to the edge of the concrete, the spacing between anchors and the thickness of the base material. The limitations in the positioning of anchors and their number in a group due to structural detailing are important parameters to be checked while selecting anchors.

**Note:** Minimum spacings, edge distances and member thickness are given in the relevant approval.

The method of setting or fixing of anchors (pre-setting vs through-setting as explained in the [Section 3.3](#)) must also be taken into account.

### 5.1.3 Loading type

Loading type such as, static/seismic/fatigue/fire etc. has an impact on the correct anchor selection as the load-bearing capacity gets changed under different loading conditions. Only anchors prequalified for the applicable loading condition may be used. The use of improperly tested and assessed anchors may lead to significant safety risks.

### 5.1.4 Loading distribution in group of anchors

The selection of an anchor is dependent on different loading types (refer to [Sections 3.4](#) and [3.5](#)). In seismic or fatigue loading, if there is gap between an anchor and the hole of the fixture, then the resistance gets reduced due to the gap effect (hammering) during dynamic loading (refer to [Section 6.10](#)). If a fastening is loaded towards the edge of a concrete member (shear load), the size of the clearance hole in the anchoring plate is very important. The hole clearance is always larger than the anchor diameter to ensure easy installation, so it is unlikely that the anchors will be uniformly loaded. EC2-4 [1] takes this fact into account by assuming that only the row of anchors nearest to the member edge takes up all the loads. The second row of anchors can be activated only if there is considerable deformation of the anchoring plate, which often leads to an edge failure of the concrete member.

To make anchors suitable for reversing cyclic action, which is true for seismic and fatigue loading, Hilti developed the filling set (refer to Fig. 5.2). This consists of a special washer, which permits HIT injection adhesive to be dispensed into the clearance hole, a spherical washer, a nut and a locknut.

**Note:** Refer to data sheet and IFU for Hilti filling set available in Hilti online.

**Note:** Using the Hilti filling set, the shear resistance is improved significantly. The unfavorable assumption of only one row of anchors taking up all loads may be omitted, and the loads are distributed uniformly among all anchors (see SOFA Method in [Section 6.5.1](#) for more details).

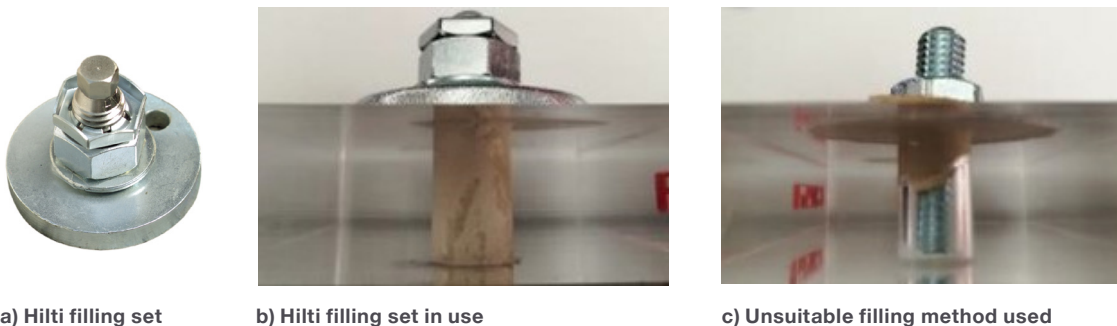

Fig. 5.2: Hilti filling set

### 5.1.5 Environmental conditions

The environment often dictates the choice of an anchor type.

The temperature during installation and the in-service condition plays a significant role in anchor selection as it is important for the curing process of chemical anchors. It becomes harder to inject adhesive at low temperatures due to an increase in viscosity. The anchors must be designed with the **in-service temperature ranges** specified in the relevant ETA and **Installation temperature range** according to IFU and associated curing time must be observed.

**Note:** The main three factors influencing corrosion: temperature / humidity, sulfur dioxide and chlorides.

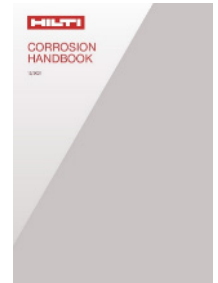

The **in-service exposure conditions** determine the necessary corrosion resistance of the anchor. The potential for corrosion is an important criterion for selecting an anchor, e.g., in marine environments, high corrosion protection is required. For mechanical anchors as well as bonded anchors, corrosion resistance for the steel element, nut and washer, and adhesive needs to be taken into consideration. The most common environmental corrosion is electrochemical corrosion. Electrochemical corrosion exists in three main forms: uniform surface corrosion, galvanic corrosion, and pitting corrosion. There are many methods of resisting corrosion by using the proper anchors. **Zinc-coated carbon steel** anchors provide sufficient protection when there is low risk of corrosion forming, e.g., dry indoor environment. For outdoor, potentially wet environments, a **stainless steel** solution is a better choice. When harsh chemicals that are prone to electrochemical corrosion are present, **highly corrosion-resistant steel** should be used, e.g., de-icing salt.

Hot-dip galvanized or stainless-steel anchors may be suitable for outdoor environments with certain lifetime and application restrictions. Anchors made of galvanized carbon steel or stainless-steel grade A2 may only be used in structures subject to dry indoor conditions, based on an assumed working life of the anchor of 50 years. From the extensive studies on the corrosion behavior of various materials in road tunnels, it is observed that some special corrosion resistance material is required to sustain anchors in this highly corrosive environment. The high-alloyed stainless-steel grade 1.4529 (HCR) has proven to be the one material that shows little to no signs of corrosion. Stainless steel in the corrosion resistance class III (“A4 class”) is in general used for outdoor/marine applications, but can be used for chemical exposure, high humidity, and long-term durability as well. Some examples of corrosive environments are shown in Fig. 5.3. For more details refer to the Hilti “**Corrosion Handbook**” [28].



a) Road tunnels are highly corrosive environments



b) Heavy corrosion of a zinc plated carbon-steel washer



c) Corrosion of a steel bracket in an indoor swimming pool

Fig. 5.3: Some examples of corrosion situations

EC2-4 [1] defines the corrosion requirement for anchors and divides the application/condition in three categories.

- 1) **Fasteners in dry / internal conditions:** do not require any significant corrosion protection, e.g., an electro zinc coating is sufficient. This exposure condition is the same as X0 and XC1 as per EC2-1-1 [27].
- 2) **Fasteners in external atmospheric or in permanently damp internal exposure conditions:** stainless steel fasteners of the proper grade are recommended and they depend on service environments: marine, industrial etc. In general, austenitic steels with at least 17% chromium and

12% nickel and additionally molybdenum may be used. This exposure condition is the same as XC2, XC3 and XC4 as per EC2-1-1 [27].

- 3) **Fasteners in high corrosion exposure because of chloride and sulfur dioxide:** if anchors are in any of these two broad environments: a) immersion in seawater or a splash zone, the chloride atmosphere of indoor swimming pools, road tunnels or car parks etc. where there is use of de-icing materials; and b) extreme chemical pollution with exposure to sulfur dioxide; the anchors should be made of stainless steel designed for high corrosion exposure. In general, stainless steel with about 20% chromium, 20% nickel and 6% molybdenum should be used in highly corrosive conditions. This exposure condition is the same as XD and XS as per EC2-1-1 [27].

## 5.2 Hilti solutions

Hilti offers a range of anchors, designed to provide safe and reliable fastening in various construction applications. These are some of the anchor solutions provided by Hilti:

**Expansion anchors:** Hilti offers a variety of expansion anchors (e.g., HST series), including wedge anchors, sleeve anchors and drop-in anchors. They provide high load capacity and can be used for both static and dynamic loads.

**Screw anchors:** Hilti's screw anchors (e.g., HUS series) are versatile and productive fastening solutions that provide high performance in a wide range of base materials, including concrete, masonry and drywall. These anchors feature self-tapping threads that support an easy installation and they can be used for both temporary and permanent applications.

**Undercut anchors:** Hilti's undercut anchors, such as the HDA series, are ideal for applications where high load-bearing capacity and small edge distances are required. These anchors provide excellent performance in cracked concrete.

**Bonded/chemical anchors:** Hilti's chemical anchors are designed to bond with the base material, providing high load-bearing capacity. These anchors are typically used in applications where heavy loads, small edge and spacing, are present and variable embedment depth is required. Hilti's chemical anchors include injection systems Hilti HIT, and HVU capsules such as:

- Hybrid mineral mortars, fast curing (e.g., Hilti HIT-HY 200-A V3)
- Epoxy mortars, slow curing (e.g., Hilti HIT-RE 500 V4)
- Capsule mortar systems (HVU2)

The **Fastening Technology Manual (FTM)** [29] provides more detailed and precise information on the individual mechanical and chemical properties of all Hilti post-installed fastening systems, considering the main influencing factors/conditions for which the anchors need to be designed. It also offers guidance on design standard and qualification documents which help designers to select the right anchor solution for a particular application.

**Note:** Hilti provides comprehensive technical data, design software and engineering support to assist customers in selecting the most suitable anchor solution for their specific applications. It is recommended to consult with Hilti's technical experts or visit the official website for detailed information on specific anchor products and their applications.

Properties of some key products are described in Table 5.1 (mechanical anchors), Table 5.2 and Table 5.3 (bonded anchors). Special anchors are shown in Table 5.4.

**Note:** Refer to Hilti FTM for more details.



Table 5.1.: Important features of some of the main Hilti mechanical anchors







Product	HST-4	HSL4	HDA	HUS4
<b>Mechanical fasteners</b>				
<b>Working principle</b>	Friction	Friction	Mechanical interlock	Mechanical interlock
<b>Setting type</b>	Pre/through setting	Pre/through setting	Pre/through setting	Through-setting
<b>Portfolio size</b>	M8 to M20	M8 to M24	M10 to M20	d8 to d16
<b>Qualification</b>	EAD 330232 (static, seismic, fire), EAD 330250 (fatigue)			
<b>Design</b>	EC2-4	EC2-4, EOTA TR 061	EC2-4, EOTA TR 061	EC2-4
<b>ETA</b>	ETA-21/0878	ETA-19/0556	ETA-99/0009	ETA-20/0867
<b>Material</b>	Carbon steel galvanized, stainless steel	Carbon steel galvanized	Galvanized steel, stainless steel	Galvanized steel, stainless steel
<b>Performance attributes</b>	Static, seismic, fire	Static, seismic, fatigue, fire	Static, seismic, fatigue, fire	Static, seismic, fire
<b>Minimum edge distance</b>	40 mm to 80 mm	60 mm to 120 mm	80 mm to 200 mm	35 mm to 65 mm
<b>Effective embedment depth</b>	30 mm to 180 mm	60 mm to 210 mm	100 mm to 250 mm	40 mm to 130 mm
<b>Max working life</b>	50 years	50 years	50 years	50 years

Table 5.2: Important features of some of the main Hilti chemical anchors

Product	HIT-RE 500 V4	HIT-HY 200-A V3	HVU2
			
<b>Working principle</b>	Bonding	Bonding	Bonding
<b>Qualification</b>	EAD 330499 (static, seismic, fire), EAD 330250 (fatigue)		
<b>Design</b>	EC2-4, EOTA TR 082, EOTA TR 061	EC2-4, EOTA TR 082, EOTA TR 061	EC2-4, EOTA TR082, EOTA TR 061
<b>ETA</b>	ETA-20/0541, ETA-23/0277	ETA-19/0601, ETA-23/0277	ETA-16/0515, ETA-23/0277
<b>Minimum and maximum embedment length</b>	From Min (60 mm; 4d) to 20d		80 mm to 270 mm
<b>Performance attributes</b>	Static, seismic, fire	Static, seismic, fire	Static, seismic, fire
<b>Min./max. installation temperature</b>	-5°C to +40°C	-10°C to +40°C	-10°C to +40°C

**Note:** Refer to Expert Report by Prof. K. Bergmeister for 120 years' service life design with HIT-RE 500 V4 and HIT-HY200-A V3

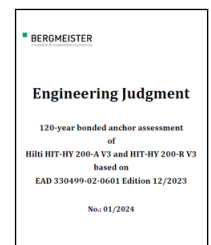

Product	HIT-HY 200-A V3	HIT-RE 500 V4	HVU2
<b>In-service temperature (Max. long temperature and max. short temperature)</b>	Temp range 1: +24°C / +40°C Temp range 2: +43°C / +55°C Temp range 3: +55°C / +75°C	Temp range 1: +24°C / +40°C Temp range 2: +50°C / +80°C Temp range 3: +72°C / +120°C	Temp range 1: +24°C / +40°C Temp range 2: +50°C / +80°C Temp range 3: +72°C / +120°C
<b>Working time @ 20°C</b>	30 min	9 min	Instant
<b>Curing time @ 20°C</b>	7 hours	60 min	5 min
<b>Max. service life</b>	100 years	100 years	50 years

Table 5.3: Different steel elements for bonded anchors







Product	HIT-HY 200-A V3 HIT-RE 500 V4	HIT-HY 200-A V3 HIT-RE 500 V4 HVU2	HIT-HY 200-A V3	HIT-HY 200-A V3	HVU2
					
<b>Portfolio size</b>	M8-M30	M8-M20	M8-M20	M12-M20	M8-M30
<b>Setting type</b>	Pre/through-setting	Pre/through-setting	Pre/through-setting	Pre/through-setting	Pre/through-setting
<b>Anchor denominations</b>	Anchor rod: HAS-U HAS-U HDG HAS-U A4 HAS-U HCR	Internally threaded sleeve: HIS-N HIS-RN	Anchor rod: HIT-Z HIT-Z-F HIT-Z-R	Anchor rod: HAS-D	Anchor rod: HAS-U(-P) HAS-U(-P) HDG HAS-U(-P) A4 HAS-U(-P) HCR

Table 5.4: Important features of some of the most popular Hilti hybrid anchors

Product	HIT-Z	Hybrid HUS
		
<b>Working principle</b>	Bonded expansion fastener	Mechanical interlock and bonding
<b>Setting type</b>	Pre/through-setting	Through-setting
<b>Portfolio size</b>	M8 to M20	d10 to d16
<b>Qualification</b>	EAD 330499	EAD 332795
<b>Design</b>	EC2-4	EOTA TR 075
<b>ETA</b>	ETA-12/0006	ETA-18/1160
<b>Performance attributes</b>	Static, seismic	Static, seismic, fire
<b>Min/max. installation temperature</b>	+5°C to +40°C	-10°C to +40°C
<b>Working time @ 20°C</b>	9 min	Instant
<b>Curing time @ 20°C</b>	60 min	Immediate loading possible
<b>Max. service life</b>	100 years	50 years

**Note:** Hilti provides technical data for threaded rods up to M80 in combination with HIT-RE 500 V4

**Note:** All information mentioned in this section is usually part of the scope of an ETA and instruction for use (IFU) provided by Hilti. Please contact Hilti for help with applications under special conditions.

### 5.3 Mechanical or bonded anchor: when to use which?

There are pros or cons when using mechanical or bonded anchors, depending on the jobsite requirement and design conditions as shown in Table 5.5.

Table 5.5: Key points for proper selection of anchors

Type of anchor	Mechanical	Chemical
Working principle	Mechanical interlock or friction	Bonding
Anchor loading conditions	Immediately	Require certain curing time to be loaded fully
Edge and spacing requirement	Large edge and spacing distance (except screw fastener and undercut fastener)	Suitable for smaller edge and spacing distances
Base material condition	Strong and stable base material that can withstand the installation forces	Suitable also for low-strength base material
Hole cleaning	Less sensitive to poor hole cleaning	More sensitive to poor hole cleaning
Embedment depth	Fixed embedment depth or small variations possible	Variable and large embedment depth available
Installation and in-service temperature	Not relevant	More sensitive
Creep behavior	Not relevant	Significant effect due to sustained load

### 5.4 Hilti as total solution provider

Hilti has a portfolio of **mechanical and chemical anchors** to cover the vast majority of applications and loading cases under different environmental conditions. Furthermore, Hilti offers a complete package, necessary technical expertise, design software, documentation and support services. Hilti also offers a solution for the reliable identification of concrete anchors through **Tracefast technology** (refer to [Section 8.3.7](#)). This technology helps making every fastener traceable, identifying what has been installed and producing shareable standardized documentation.

The entire workflow of a project can be grouped into three phases - the **design, construction** and **inspection** phases. The two major phases are the design and the construction phases. During first one it is the designers' responsibility to find the most suitable, optimized and approved design solutions within shortest possible timeframe. For builders/contractors, the key areas of challenge are quality of installation, jobsite productivity and documentation to satisfy the project need. The entire portfolio of Hilti as end-to-end solution provider is displayed in Fig. 5.4.

**Note:** Tracefast can be key in highly safety relevant applications such as in nuclear power plants.



**Note:** Hilti can support you from the initial design phase with a proposal of the right solution at the right time for safer installation. Hilti also offers to assess the performance of anchors by partnering with various stakeholders: designers/specifiers, engineers, contractors, site team and project owners.

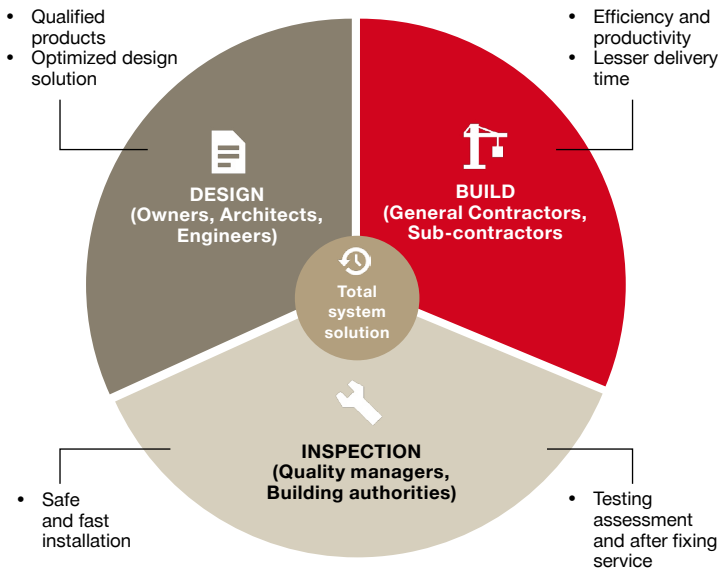

Fig. 5.4: Hilti as a total system provider for post-installed anchors

## 5.5 Design and installation steps

The two major phases – designing and installing post-installed anchors – involve several steps to ensure their proper design and installation. Different personas are involved and responsible for different phases of the workflow. The steps of application and activities are defined in Fig. 5.5.

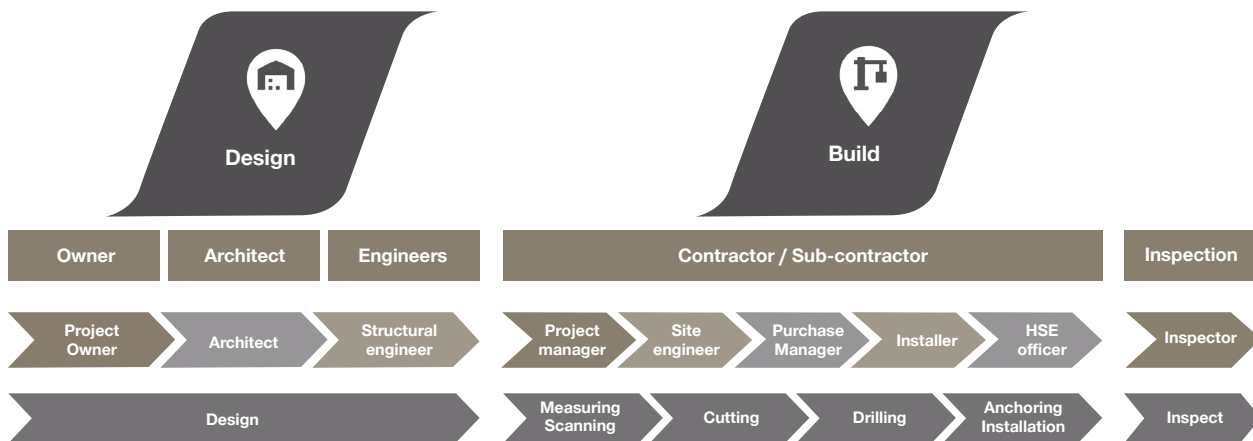

Fig. 5.5: Workflow chart for application of post-installed anchors for S2C connection

### 1. Conceptual design phase:

- Determine the architectural and structural criteria like shape, size, span, thickness, exposure, durability and sustainability requirements for the project.
- Determine existing structure type, structural elements and their details.
- Select general design criteria and objectives, governing codes/standards, ETAs, solution selection criteria and preliminary design values to start the design.

**Note:** Refer to the Hilti Fastening Technology Manual (FTM) for product performance to be used for conceptual design.

### 2. Structural analysis:

- Determine design loading requirements (static, seismic, fire, fatigue).
- Determine installation conditions relevant to design.
- Check the connection profile of metal and size of base material.

- Choose appropriate design method.
- Set target capacity (utilization ratio) and/or allowable stress limits.
- Determine load combinations.

### 3. Detailed design/specification

- Understand the specific requirements of the project and determine the purpose of the anchor installation.
- Select the appropriate anchor type based on the application and load requirements.
- Plan the layout and spacing of the anchors based on the load requirements and structural considerations.
- Calculate and check service and ultimate stress limits.
- Check utilization ratio for different failure modes and their combinations.

**Note:** Use Hilti PROFIS Engineering for detailed design (refer to [Chapter 7](#)).



### 4. Construction documents

- Prepare construction drawings showing position, spacing and embedment of post-installed anchors.
- Call out specifications, installation and application methods.
- Provide inspection/quality control requirements for the jobsite.

### 5. Installation

- Locate anchor positions after scanning the base material.
- Surface preparation.
- Drilling.
- Cleaning holes.
- Anchor setting.

## 5.6 SPEC2SITE solutions

Hilti offers a wide portfolio of solutions for your structural connections, and we want to make it easy for our partners to navigate our portfolio and select the best solution for their application conditions. We do this by offering SPEC2SITE solutions.

**SPEC2SITE**

With **SPEC2SITE** solutions we aim to improve every step of your application workflow and connect the design specification to the execution on the jobsite. **For the engineer**, these solutions help make specifications higher performing and value engineered, while providing more peace of mind and more sustainable designs. **For the contractor**, these solutions help make jobsite practices faster, simpler, safer and more sustainable. When we combine better specifications and better jobsite practices with our onsite support, we help ensure that the application can be executed and installed as specified. Please discover more on our website or by contacting our engineering team.



## 6. DESIGN OF ANCHORS

### 6.1 Design principles

In earlier chapters we have discussed the various loading conditions which post-installed anchors can experience in both structural and non-structural applications. The loading conditions/actions are based on the relevant European standards as mentioned in [Section 4.2](#). In this section, the design provisions based on EC2-4 [1] and relevant EOTA TRs are described. The design should confirm adherence to the requirement of serviceability and ultimate limit state. The **serviceability limit state (SLS)** includes the requirement for limiting deformation and durability. At **ultimate limit state (ULS)**, it must be ensured that the design value of action ( $E_d$ ) does not exceed the design value of the resistance ( $R_d$ ) as shown in Fig. 6.1. The design action is amplified ( $E_k \cdot \gamma_F$ ) and on the other side the resistance is reduced ( $F_{Rk}/\gamma_M$ ) by using some partial safety factors ( $\gamma_F$  and  $\gamma_M \geq 1.0$ ) to reach an adequate level of safety.

**Ultimate limit state design concept:**

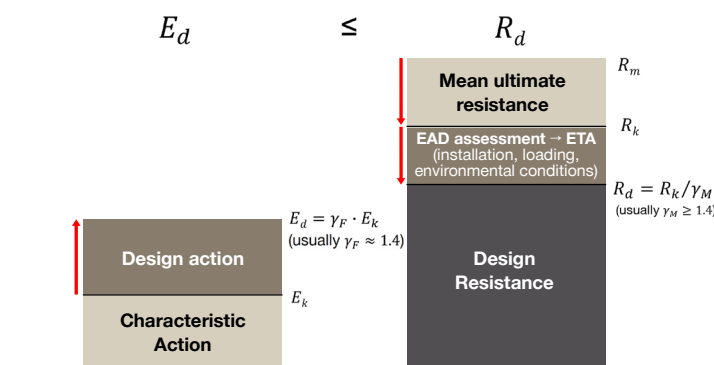

Fig. 6.1: Partial safety factor concept-amplifying action and lowering down resistance (example for static design)

### 6.2 Anchor configurations permitted as per EC2-4

The applicability of the design provisions of EC2-4 [1] is limited to the fastening configurations shown in Fig. 6.2 and Fig. 6.3. An anchor located at an **edge distance  $\geq \max(10h_{ef}; 60d_{nom})$**  is considered to be “far” from the edge, otherwise it is considered to be situated “near” to the edge. In far edge conditions, the check for concrete edge break-out under shear loading may be omitted. Fig. 6.2 shows permitted anchor configurations for fastenings without hole clearance for all edge distances and all load directions, and fastenings with normal hole clearance according to EC2-4 [1] (refer to Table 6.1) situated far from edges for all load directions and situated near to edge loaded in tension only. Fig. 6.3 shows permitted anchor configurations for fastenings with a hole clearance situated near to edge for all load directions.

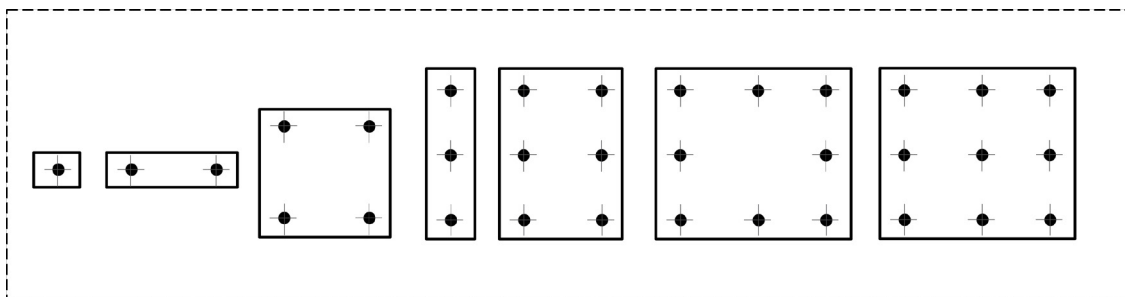

Fig. 6.2: Fastening without hole clearance for all edge distances - by EC2-4 covered configurations

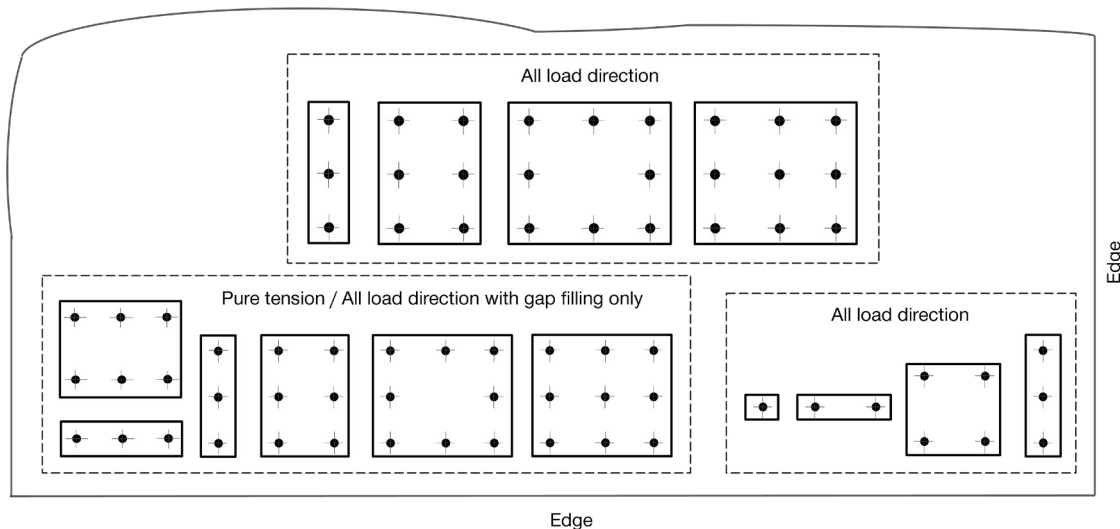

Fig. 6.3: Fastening with hole clearances situated near to edge - by EC2-4 covered configurations

### 6.3 Actions on fasteners (rigid vs. flexible baseplate)

EC2-4 [1] covers design of fastenings, for which the **fixture is considered to be rigid** (as illustrated in Fig. 6.4 a)). The following conditions must be fulfilled:

- All anchors in the group have the same axial stiffness, i.e., only fasteners with the same diameter and embedment can be used within a group. This allows for the assumption of linear strain distribution.
- The fixture remains elastic under design forces and its deformation is negligible in comparison to the axial displacement of the anchors.

**Note:** Design according to EC2-4 assumes a rigid baseplate and consequent linear stress distribution.

In the zone of compression under the fixture, it is assumed that the anchors do not take up normal forces and the compression forces are transmitted to the concrete by the fixture. The axial and shear actions, as well as bending moment, acting on the fastening may be resolved into forces acting on each anchor by assuming a linear distribution of strain.

If the baseplate cannot be assumed as rigid, the forces on an anchor are higher due to shortening of the lever arm and additional prying forces (refer to Fig. 6.4 b)). To assess the amplitude of the forces acting on the anchors, their stiffnesses need to be taken into account in the analysis. EC2-4 [1] does not provide guidance for design of fastenings with a flexible fixture. The Hilti software PROFIS Engineering allows Component Based Finite Element Modeling (CBFEM) which assumes a non-rigid plate behavior and provides an alternative to the classical rigid baseplate design methodology. Refer to CBFEM in PROFIS engineering [Chapter 7](#) (Fig. 7.9).

**Note:** The consideration of rigid baseplate depends on the structural design criteria and the choice of designer.

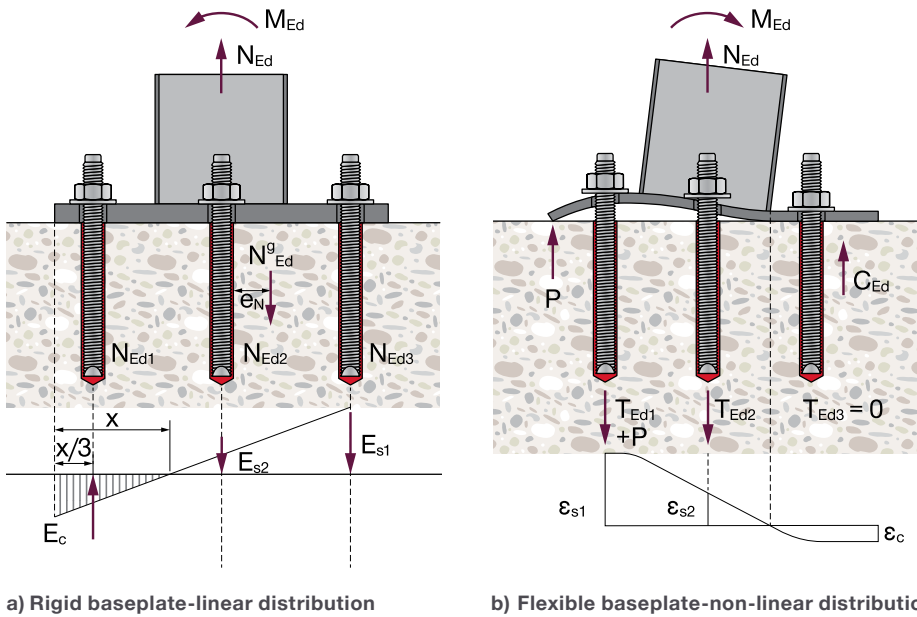

Fig. 6.4: Examples of distribution of strains and anchor forces for a fastening system subjected to bending moment and normal forces

### 6.3.1 Analysis of tension loads

According to EC2-4 [1], the tension load distribution to the anchors may be calculated analogous to the elastic analysis of reinforced concrete. For anchor groups with different levels of tension forces  $N_{Ed,i}$  acting on the individual fasteners of a group, the eccentricity  $e_N$  of the tension force  $N_{Ed}^g$  of the group with respect to the center of gravity of the tensioned fasteners influences the concrete-related resistances of the group. An example of tension loading condition on anchors in a group is shown in Fig. 6.5. More examples are provided in EC2-4 [1]

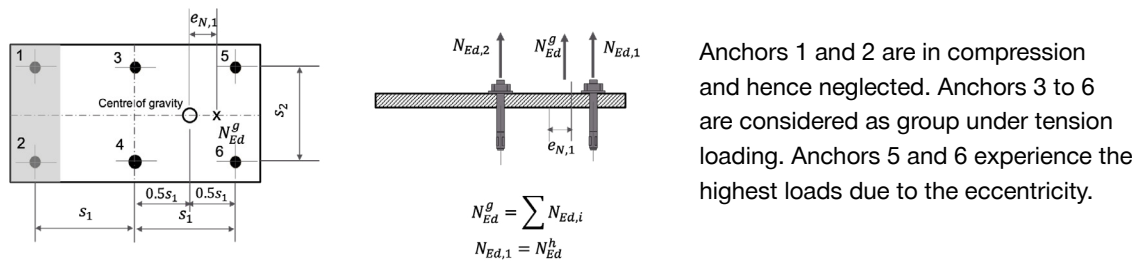

Fig. 6.5: Example of determination of tension load on the individual anchors of a group

### 6.3.2 Analysis of shear loads

The design shear force is distributed to the anchors based on its effectiveness to resist shear load, which in turn is dependent on the hole clearance (as per Table 6.1) and the edge distance. If the hole is slotted in the direction of the shear force, then the anchor doesn't take up the shear loads. All anchors are considered to take up shear load if the shear is acting parallel to the edge or they are subjected to torsion or are located far from the edge ( $c_i \geq \max\{10h_{ef}; 60d_{nom}\}$ ). For steel and pry-out checks, all anchors of an anchor group are considered effective. For concrete edge failure check, only the anchors close to the edge ( $c_i < \max\{10h_{ef}; 60d_{nom}\}$ ) are effective in resisting shear acting perpendicular or parallel to the edge.

**Note:** According to EC2-4 the friction between concrete and baseplate is conservatively neglected.

Table 6.1: Normal hole clearance for anchors according to EC2-4 [1]

External diameter of anchor ( $d^a$ or $d_{nom}^b$ )	6 mm to 8 mm	10 mm to 24 mm	27 mm and above
Diameter of clearance hole in fixture ( $d_f$ )	$d + 1$ or $d_{nom} + 1$	$d + 2$ or $d_{nom} + 2$	$d + 3$ or $d_{nom} + 3$
(a) If bolt bears against the fixture			(b) If sleeve bears against the fixture

**Note:** Follow the IFU of the relevant Hilti product for guidance on hole clearance in the baseplate in the case of through setting with bonded anchors

Fig. 6.6 to Fig. 6.10 describe how shear load acts and fasteners participate in sharing the shear load in near edge conditions. In the case of a group of fasteners loaded parallel to the edge, the shear load is divided equally among all anchors. However, only the verification of anchors closer to edge is required (Fig. 6.6). For a group of fasteners loaded perpendicular to the edge, the shear load is taken by the front row of anchors only (Fig. 6.7). Components of shear loads acting away from the edge are neglected in concrete edge resistance. Check for anchors close to the edge is required (Fig. 6.8).

If a group of anchors is placed in corner condition, both edges should be verified considering the load acting parallel and perpendicular as shown in Fig. 6.9 and Fig. 6.10 respectively. If the shear load acts with an inclination towards an edge, the rules shown in Fig. 6.6 to Fig. 6.10 apply to the perpendicular and parallel components of the shear load accordingly.

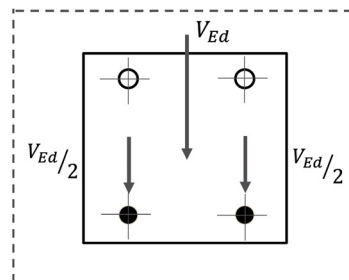
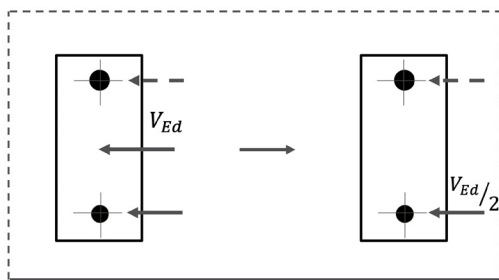

← - - Load distribution to the anchor is not considered for concrete edge failure verification

● Loaded anchor

← Load distribution to the anchor is considered for concrete edge failure verification

○ Unloaded anchor

Fig. 6.6: Group of two anchors close to an edge loaded parallel to the edge

Fig. 6.7: Group of four anchors close to an edge loaded perpendicular to the edge

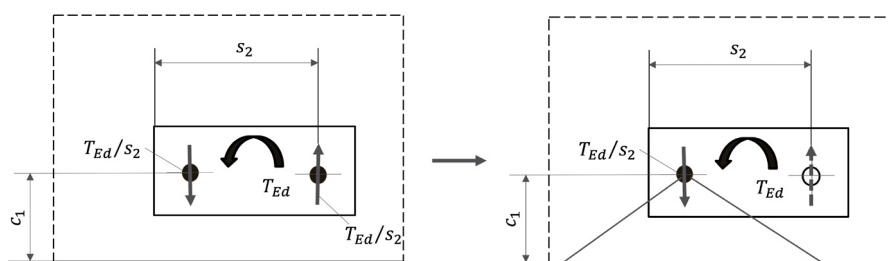

Fig. 6.8: Group of two anchors close to the edge loaded in torsion

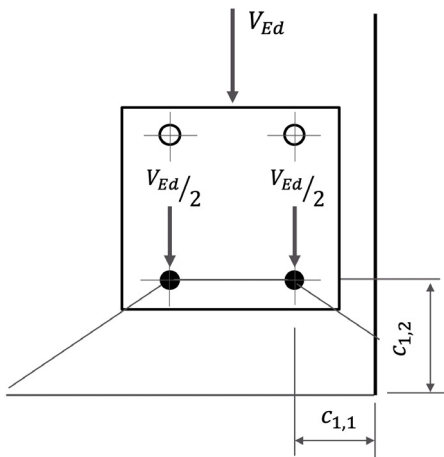

Fig. 6.9: Group of four anchors close to an edge loaded perpendicular to the edge

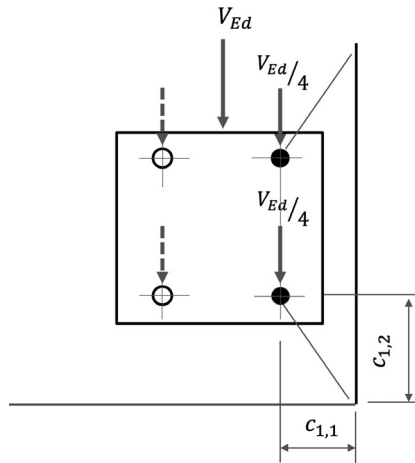

Fig. 6.10: Shear load acting parallel to the edge

## 6.4 Alternative approaches for distribution of shear force as in fib Bulletin 58

EC2-4 [1] has some limitations in distribution of shear loads within group of anchors close to the edge. “*Design of anchorages in concrete*” fib Bulletin 58 [30] gives some additional conditions for resistance against shear load. It allows equal shear distribution among all anchors with no or normal annular gap between a baseplate and anchors of 3 rows parallel to the edge. More details are provided in the following section.

## 6.5 SOFA method

In practical scenarios, sometimes the connection between steel section and concrete is done using multiple anchors beyond the scope of EC2-4 [1] (anchor groups with more than 3x3 numbers, Fig. 6.11).

The Hilti software solution PROFIS Engineering (refer to [Chapter 7](#)) offers two solutions for the design of fastenings: design compliant with EC2-4 [1] and as per the **Hilti SOFA Method** (*SOLutions for FAsTening*).

The Hilti SOFA Method provides design approaches which reflect state-of-the-art research in this field. It is recommended in cases where EC2-4 [1] does not provide a viable solution.

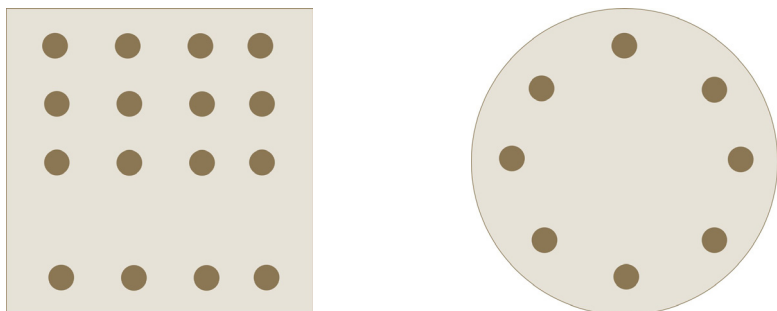

Fig. 6.11: Baseplate connection using group of anchors (4x2)

### 6.5.1 Shear distribution and anchor layout covered in SOFA method

The SOFA method considers **shear distribution of anchors with 3 rows in a group**, with or without hole clearance as per fib Bulletin 58 [30]. It also extends the fastening layout up to 99 anchors using the gap

filling technique (Fig. 6.12 a)). Also, shear distribution for regular and irregular configurations is defined (Fig. 6.12 b)). It provides flexibility to the designer to choose a fastening configuration beyond EC2-4 [1] (Fig. 6.2 and Fig. 6.3).



a) Anchor layout rectangular beyond 3x3      b) Anchor layout in irregular shape

Fig. 6.12: Anchor arrangement allowed in SOFA

Anchors experiencing only tension loading don't require gap filling for the layout of rectangular beyond 3x3, triangular, circular. For other irregular layouts gap filling is required for both tension and shear. For an anchor arrangement of 3 rows, shear distribution follows fib Bulletin 58 [30]. For layouts beyond 3 rows, homogenous shear distribution no further increase of the resistance against concrete to edge breakout is possible (Fig. 6.13 a)). This limitation is based on the current research experience (see e.g. [31]). If anchor layouts follow other irregular shapes, i.e., circular, triangular etc. the bandwidth method allows concrete edge capacity to the fasteners in the front area as shown in Fig. 6.13 b).

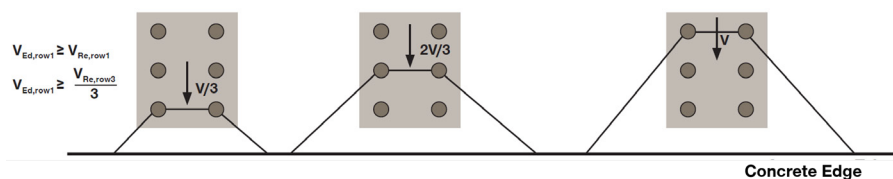

a) Shear distribution among front row of anchors

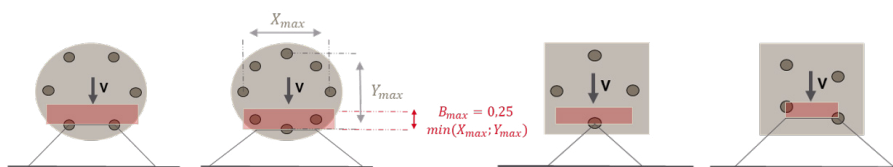

b) Definition of bandwidth to extend edge capacity behind front anchors

Fig. 6.13: Shear distribution in SOFA

### 6.5.2 SOFA gives higher resistance for grouted and ungrouted stand-off applications

The SOFA method provides comprehensive solutions for both **stand-off ungrouted and grouted connections** (Fig. 6.14) and allows flexibility in design of several applications beyond EC2-4 [1] and fib Bulletin 58 [30]. This method is based on the research by McBride [32].

An ungrouted stand-off baseplate refers to a baseplate that is not in contact to the base material but connected only via anchors (Fig. 6.14 a)). A grouted stand-off baseplate refers to a baseplate that is in contact with the base material using a grout layer. In the case of a grouted stand-off baseplate, the grout is poured into the gap between the baseplate and the concrete, creating a solid connection between them (Fig. 6.14 b)).

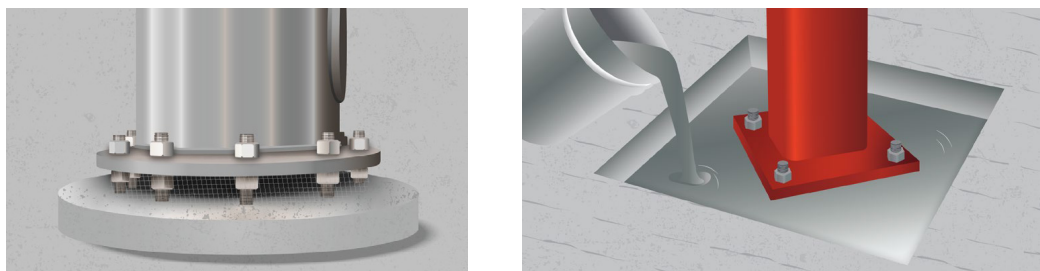

a) Ungrouted stand-off connection: in service      b) Installation of flowable grout in recessed column base

Fig. 6.14: Ungrouted and grouted stand-off

**Note:** When an ungrouted stand-off connection is subjected to a bending moment, some of the anchors have to transfer compression forces in the base material. In such case the choice of the right type of anchor is key, because only some types can transfer such forces, e.g., bonded anchors.

The comparison between SOFA method and EC2-4 [1] for stand-off applications is discussed in Table 6.2 and Table 6.3.

**Note:** Refer to the SOFA whitepapers for more details on grouted [33] and ungrouted [34] stand-off applications.

Table 6.2: Grouted stand-off applications

Property	EC2-4	SOFA method
Shear resistance	Approx 1% loss happens for each 1 mm lever arm for uncracked concrete	Max 20% loss in resistance in both cracked and uncracked concrete
Stand-off height	Stand-off height is allowed up to <i>min</i> (40 mm, 5 <i>d</i> ) for higher values, see “ungrouted stand-off”	Stand-off height is allowed up to 130 mm
Min edge distance	From product ETA	From product ETA
Effect of grout	Grout does not provide advantages	Grout is beneficial
Steel shear resistance	$V_{Rk,s} = (1 - 0.01 \cdot t_{grout}) \cdot k_7 \cdot V_{Rk,s}^0$	$V_{Rk,s} = 0.8 \cdot k_7 \cdot V_{Rk,s}^0$
Resistance to concrete edge break-out	No modification from original equation without stand-off	EC2-4 equation multiplied by reduction factor $\psi_{b,g} = \frac{1}{1 + \frac{C \cdot t_{grout}}{d^{3/4}}}$ where $C = 0.043 (mm^{-0.25})$ = constant representing elastic interaction between fastener and concrete. Bending adds to bearing pressure close to edge
Interaction between tension and shear	Verification is not required for small thicknesses of grouts.	Interaction between tension and shear is checked by $\left(\frac{N_{Ed}}{N_{Rd,s}}\right)^2 + \left(\frac{V_{Ed}}{V_{Rd,s,grout}}\right)^2 \leq 1.0$

Table 6.3: UngROUTED stand-off applications

Property	EC2-4	SOFA Method
<b>Lever arm</b>	Distance from the middle of the steel plate to the reaction point in the concrete	Distance from the bottom of the leveling nut to the reaction point in the concrete
<b>Min edge distance</b>	$\max(10h_{ef}, 60d)$ because concrete edge break-out is not covered	From product ETA
<b>Bending resistance</b>	$1.2 \cdot W_{el} \cdot f_{uk}$	$1.7 \cdot W_{el} \cdot f_{yk}$
<b>Resistance to concrete edge break-out</b>	There is no guidance on near edge stand-off conditions	EC2-4 equation multiplied by reduction factor $\psi_{b,u}$ and $\psi_{b,u} = \frac{1}{1 + \frac{C}{d^{3/4}} \alpha_M}$ , $C = 0.213 (mm^{-0.25})$ Bending adds to the bearing pressure caused by shear on the concrete close to an edge
<b>Interaction between tension and shear for steel</b>	It is satisfied between tension and shear directly through $V_{Rk,s,M}$	It is checked separately between tension and shear, $\left(\frac{N_{Ed}}{N_{Rd,s}}\right)^2 + \frac{V_{Ed}}{V_{Rd,s,M}} \leq 1.0$
	$V_{Rk,s,M} = \frac{\alpha_M \cdot M_{Rk,s}^0 \cdot \left(1 - \frac{N_{Ed}}{N_{Rd,s}}\right)}{l_a} \leq V_{Rk,s}$	$V_{Rk,s,M} = \frac{\alpha_M \cdot M_{Rk,s}^0 \cdot \left(1 - \frac{N_{Ed}}{N_{Rd,s}}\right)}{l_a} \leq V_{Rk,s} \text{ and } \alpha_{s,M} = \frac{1.5 \cdot l_a}{\alpha_M \cdot d}$

The lever arm for ungrouted stand-off connections both in EC2-4 [1] and SOFA is described in Fig. 6.15 below.

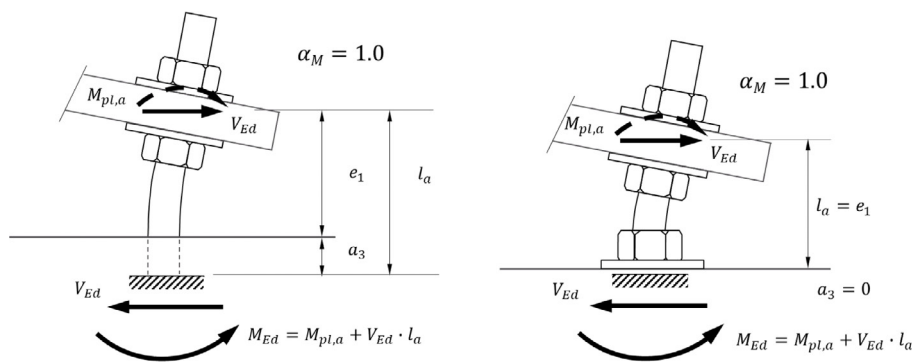

a) Unrestrained rotation of the baseplate (EC2-4 and SOFA)

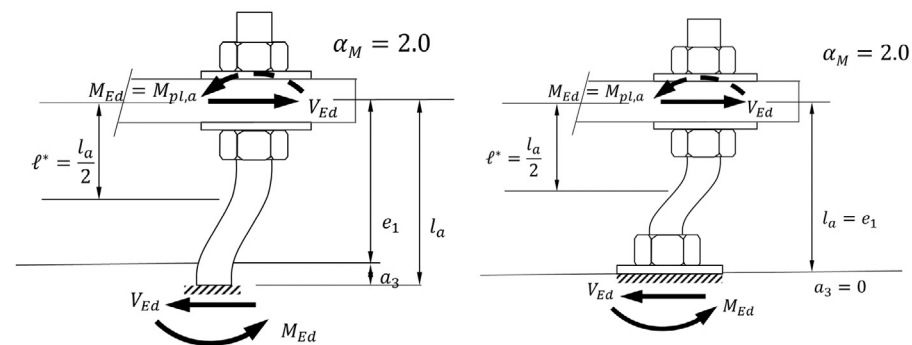

b) Restrained rotation of baseplate (EC2-4)



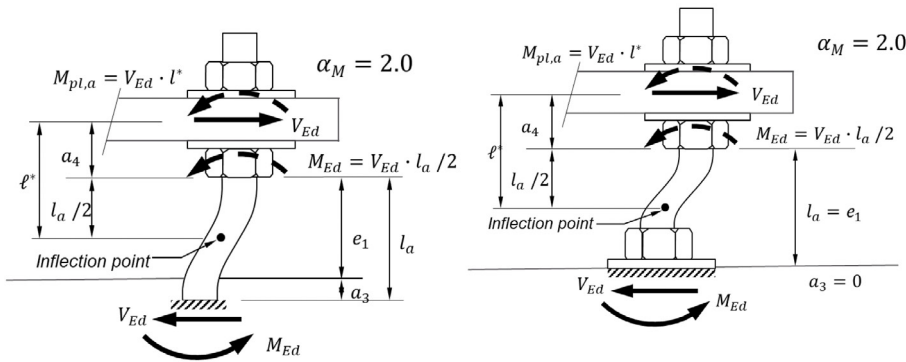

c) Restrained rotation of baseplate (SOFA)

Fig. 6.15: Considerations of lever arm calculation for ungrouted stand-off

## 6.6 Design of anchors for static loading as per EC2-4

Design verification for tension and shear load are defined separately considering all relevant failure modes for post-installed anchors as shown in Fig. 6.16.

**Note:** All concrete-related failure modes are significantly influenced by the concrete conditions (cracked/uncracked, refer to Section 3.7.1). If the designer cannot ensure that the concrete at the location of the fastening will remain uncracked during the entire working life, cracked concrete must be assumed.

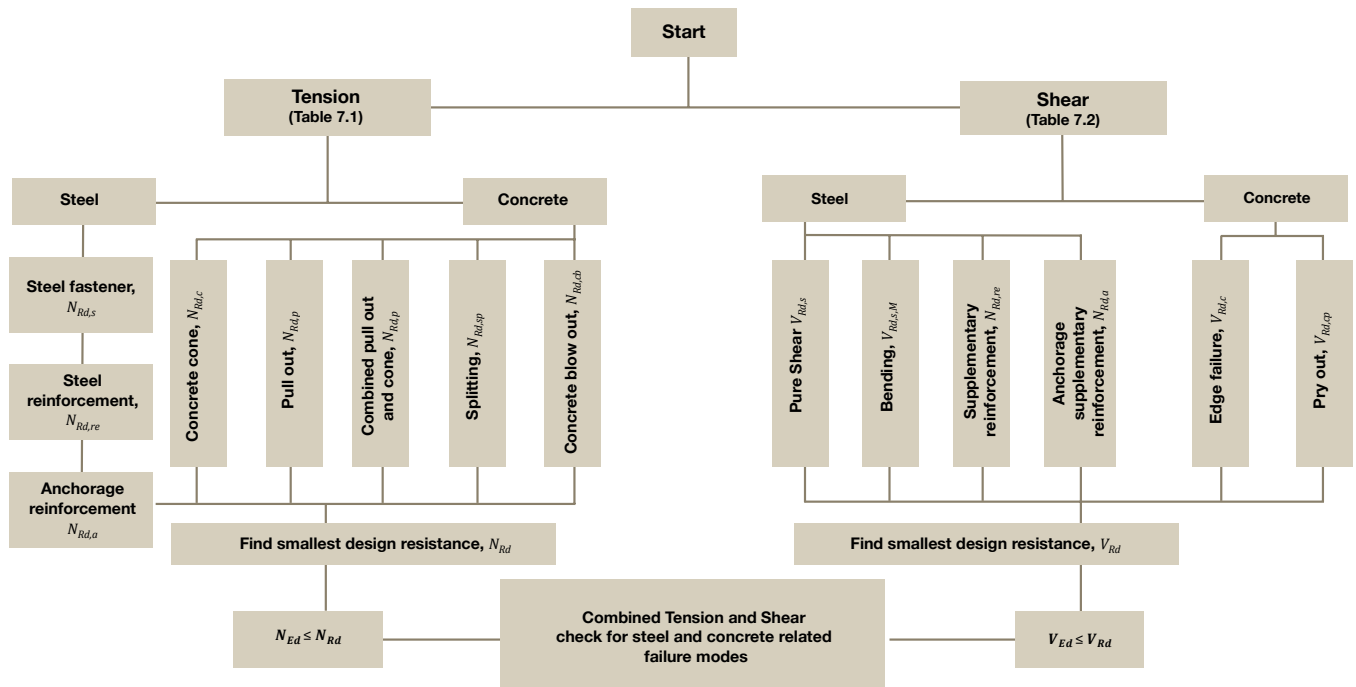

Fig. 6.16: Design proofs according to EC2-4

### 6.6.1 Verifications of anchors under tension loading

The design tension load  $N_{Ed}$  must be smaller than resistance value  $N_{Rd}$  (refer to [Section 6.1](#)). Steel and pull-out failure (resistance  $N_{Ed}^h$ ) are checked for most loaded anchor while the remaining concrete-related failure modes are checked for a group of anchors considering all related boundary conditions. Required verifications for post-installed anchors in tension are mentioned in Table 6.4.

Table 6.4: Failure modes and criteria against tension load in EC2-4 [1]

Failure mode	Single anchor	Group of anchors	
		Most loaded anchor	Group
Steel failure of anchor	$N_{Ed} \leq N_{Rd,s} = \frac{N_{Rk,s}}{\gamma_{Ms}}$	$N_{Ed}^h \leq N_{Rd,s} = \frac{N_{Rk,s}}{\gamma_{Ms}}$	
Concrete cone failure	$N_{Ed} \leq N_{Rd,c} = \frac{N_{Rk,c}}{\gamma_{Mc}}$		$N_{Ed}^g \leq N_{Rd,c} = \frac{N_{Rk,c}}{\gamma_{Mc}}$
Pull-out failure	$N_{Ed} \leq N_{Rd,p} = \frac{N_{Rk,p}}{\gamma_{Mp}}$	$N_{Ed}^h \leq N_{Rd,p} = \frac{N_{Rk,p}}{\gamma_{Mp}}$	
Combined concrete cone and pull-out failure (valid for bonded anchors only)	$N_{Ed} \leq N_{Rd,p} = \frac{N_{Rk,p}}{\gamma_{Mp}}$		$N_{Ed}^g \leq N_{Rd,p} = \frac{N_{Rk,p}}{\gamma_{Mc}}$
Concrete blow-out failure (for undercut anchors acting as headed anchors if the edge distance $c \leq 0.5 h_{ef}$ )	$N_{Ed} \leq N_{Rd,cb} = \frac{N_{Rk,cb}}{\gamma_{Mc}}$		$N_{Ed}^g \leq N_{Rd,cb} = \frac{N_{Rk,cb}}{\gamma_{Mc}}$
Concrete splitting failure	$N_{Ed} \leq N_{Rd,sp} = \frac{N_{Rk,sp}}{\gamma_{Msp}}$		$N_{Ed}^g \leq N_{Rd,sp} = \frac{N_{Rk,sp}}{\gamma_{Msp}}$

Partial factors for tension relevant failure modes are defined in Table 6.5.

Table 6.5: Partial factors for tension under static loading

Failure mode	Partial safety factor	Reference value
Steel	$\gamma_{Ms}$	$1.2 \cdot \frac{f_{uk}}{f_{yk}} \geq 1.4$
Concrete cone	$\gamma_{Mc}$	$\gamma_c \cdot \gamma_{inst}$ ( $\gamma_{inst}$ is taken from ETA and $\gamma_c = 1.5^*$ )
Pull-out	$\gamma_{Mp}$	$\gamma_{Mc}$
Combined concrete cone and pull-out	$\gamma_{Mp}$	$\gamma_{Mc}$
Concrete splitting	$\gamma_{Msp}$	$\gamma_{Mc}$

\*) If not otherwise specified in the applicable National Annex of EC2-4

### 6.6.1.1 Steel failure

This failure mode is characterized by fracture of the steel anchor parts. Steel fracture can happen if the anchor is subjected to tensile force, if the steel capacity of the anchor is not enough to withstand it. Consequently, the metal part breaks off.

**Note:** To obtain a higher resistance to this failure mode, one of these strategies (or a combination of them) can be followed: 1) increase the number of anchors; 2) select a higher steel strength for the anchor or 3) increase the anchor diameter.

The characteristic resistance of an anchor in case of steel failure,  $N_{Rk,s}$  is

$$N_{Rk,s} = A_s \cdot f_{uk}$$

$N_{Rk,s}$  value is given in the relevant ETA.

$A_s$  = stressed cross section of an anchor given in the relevant ETA and  $f_{uk}$  = nominal characteristic steel ultimate tensile strength.

### 6.6.1.2 Concrete cone failure

Concrete cone failure under tension loading occurs when the applied tensile load exceeds the capacity of the concrete engaged by the anchor group to resist it. Base material break-out under tension mainly depends on the concrete compressive strength, the concrete condition (cracked or uncracked) and the volume of concrete cone engaged. This cone depends on the embedment depth and the presence of edges. In the case of adjoining tension anchors, the overlap between concrete cones must also be considered.

**Note:** To obtain a higher concrete cone resistance, one of the strategies (or a combination of them) can be followed: 1) increasing the spacing between anchors; 2) increasing the embedment depth of anchors; 3) using a base material of higher concrete strength class.

The characteristic resistance of a fastener in case of concrete cone break-out failure,  $N_{Rk,c}$  is:

$$N_{Rk,c} = N_{Rk,c}^0 \cdot \frac{A_{c,N}}{A_{c,N}^0} \cdot \psi_{s,N} \cdot \psi_{re,N} \cdot \psi_{ec,N} \cdot \psi_{M,N} \quad \text{EC2-4, eq. (7.1)}$$

Characteristic resistance of single anchor not influenced by adjacent fasteners or edges of the concrete member,  $N_{Rk,c}^0$  is defined by concrete strength, effective depth of anchors and factors related to condition of concrete:

$$N_{Rk,c}^0 = k_1 \cdot \sqrt{f_{ck}} \cdot h_{ef}^{1,5} \quad \text{EC2-4, eq. (7.2)}$$

$f_{ck}$  = nominal characteristic compressive cylinder strength of concrete,  $h_{ef}$  = effective embedment depth of fastener.

$k_1 = k_{cr,N}$  for cracked concrete and  $k_{ucr,N}$  for uncracked concrete values are taken from the relevant ETA. Indicative values are  $k_{cr,N} = 7.7$  and  $k_{ucr,N} = 11$ .

**Note:** The assumption of cracked concrete implies a reduction of 30% of the concrete break-out resistance.

**Note:** Post-installed anchors with very good performance can achieve concrete cone resistance at the level of headed studs with  $k_{cr,N} = 8.9$  and  $k_{ucr,N} = 12.7$ . This is the case for the Hilti anchors HST4 and HDA as shown in the respective ETAs.

The geometric effect of axial spacing and edge distance on the characteristic resistance is considered by calculating the ideal concrete cone projected area of a single anchor ( $A_{c,N}^0$ ) and actual projected area ( $A_{c,N}$ ) using the ratio  $A_{c,N}/A_{c,N}^0$  (refer to Fig. 6.17):

$$A_{c,N}^0 = s_{cr,N} \cdot s_{cr,N} \quad \text{EC2-4, eq. (7.3)}$$

Spacing between anchors,  $s_{cr,N} = 2 \cdot c_{cr,N} = 3 \cdot h_{ef}$ ,  $c_{cr,N}$  = edge distance and is given in the corresponding ETA.

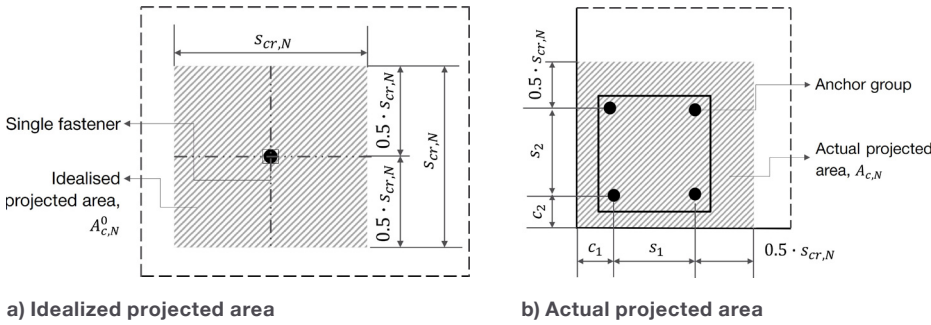

Fig. 6.17: Geometric influence area considered in cone break-out failure

Other factors which have influence on the concrete break-out resistance are described below:

For any group of anchors affected by one or more edges, the smallest edge distance needs to be considered to calculate the reduction factor,  $\psi_{s,N}$ , accounting for the disturbance of distribution of stresses in concrete. The smaller the edge distance is, the smaller will be also this factor, thereby causing a reduction in resistance value. The critical edge distance,  $c_{cr,N}$  is defined in the relevant ETA (usually,  $1.5 \cdot h_{ef}$ ). This factor is calculated by following equation in EC2-4 [1]:

$$\psi_{s,N} = 0.7 + 0.3 \cdot \frac{c}{c_{cr,N}} \leq 1 \quad \text{EC2-4, eq. (7.4)}$$

If anchors are installed in concrete with dense reinforcement, the effect of shell spalling is taken care of by factor  $\psi_{re,N}$ . For anchors with embedment depth  $h_{ef} < 100 \text{ mm}$ , the factor is calculated by using following equation:

$$\psi_{re,N} = 0.5 + \frac{h_{ef}}{200} \leq 1 \quad \text{EC2-4, eq. (7.5)}$$

The factor  $\psi_{re,N}$  may be taken as 1.0 if one of the two cases is satisfied; 1) reinforcement of any diameter is present at a spacing of  $\geq 150 \text{ mm}$ ; or 2) reinforcement of diameter  $\leq 10 \text{ mm}$  is present at a spacing  $\geq 100 \text{ mm}$ . For reinforcement in two directions, the said conditions must be satisfied in both directions.

The eccentricity is defined as distance between the point of loading and the center of gravity of the anchor group and is taken into account by the factor  $\psi_{ec,N}$ . If there is eccentricity in two directions, this factor needs to be calculated separately for both the directions:

$$\psi_{ec,N} = \frac{1}{1 + \left(\frac{z \cdot e_N}{s_{cr,N}}\right)^2} \quad \text{EC2-4, eq. (7.6)}$$

If an anchor group experience a bending moment which results in tension and compression forces between the fixture and concrete, the effect of compression force is considered by factor  $\psi_{M,N}$ .  $\psi_{M,N}$  has to be taken as 1.0, if the edge distance  $c < 1.5 \cdot h_{ef}$  or ratio between the distance of neutral axis and embedment depth  $z / h_{ef} \geq 1.5$ . For anchor groups with edge distance  $c \geq 1.5 \cdot h_{ef}$  and ratio between resultant compression force and tension force  $C_{Ed} / N_{Ed} < 0.8$ , this factor is also to be taken as 1.0. For all other cases,  $\psi_{M,N}$  is calculated as per below equation in EC2-4 [1]:

**Note:** This factor  $\psi_{M,N}$  can significantly increase the concrete cone break-out resistance due to the positive effect of the compression originating from the bending moment.

$$\psi_{M,N} = 2 - \frac{z}{1.5 \cdot h_{ef}} \geq 1.0 \quad \text{EC2-4, eq. (7.7)}$$

If the bending acts in two directions,  $z$  shall be determined for the combined action of moments in two directions and axial force.

If any anchor or anchor group is bounded by three or more edges with edge distance of less than  $c_{cr,N}$ , the value  $h_{ef}$  is modified by introducing the ratio between maximum edge distance  $c_{max}$  and critical edge distance  $c_{cr,N}$ .

$$h'_{ef} = \left\{ \frac{c_{max}}{c_{cr,N}} \cdot h_{ef} \right\} \text{ for single fastener} \quad \text{EC2-4, eq. (7.8)}$$

In case of group,  $h'_{ef}$  is considered as the maximum of ratios between edge distances and spacings ( $s_{max}, s_{cr,N}$ ), refer to Fig. 6.18:

$$h'_{ef} = \max \left\{ \frac{c_{max}}{c_{cr,N}} \cdot h_{ef}; \frac{s_{max}}{s} \cdot h_{ef} \right\} \quad \text{EC2-4, eq. (7.9)}$$

For an anchor without hole clearance where three anchors in a row close to an edge are allowed,  $s_{max}$  is the maximum center-to-center distance of outer fasteners  $\leq 2 s_{cr,N}$ . Anchors configured with three and all four edges with rectangular baseplate are shown in Fig. 6.18.

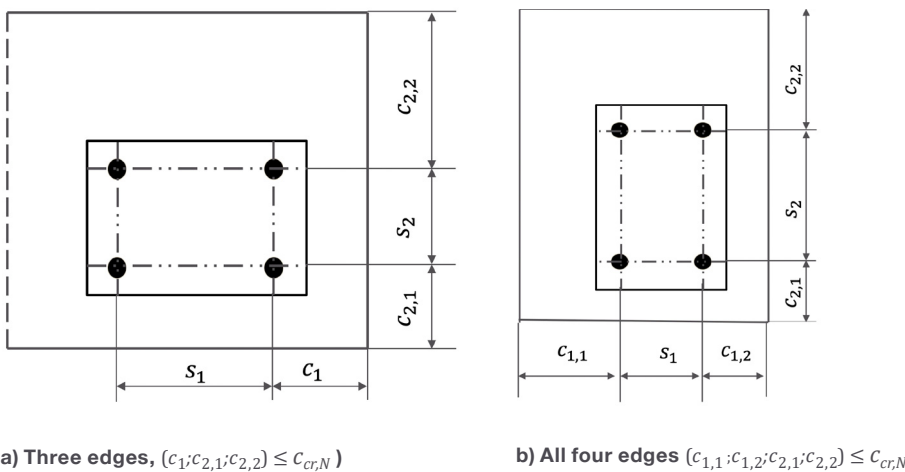

Fig. 6.18: Anchors with three or more than three edges

### 6.6.1.3 Concrete pull-out failure

If steel and concrete are strong enough to sustain the load, it is time to check whether the anchor is capable of transferring it to the base material. The failure mode in which the anchor is extracted out of the concrete without development of the full concrete resistance is referred as pull-out. The pull-out failure under tension for post-installed anchors depends on various factors, including the anchor type, installation method, substrate material.

The characteristic resistance of a fastener in case of pull-out failure,  $N_{Rk,p}$  is taken from the relevant ETA.

**Note:** To improve the pull-out resistance one of the strategies (or a combination of them) can be followed: 1) choice of an anchor with higher resistance 2) increasing the anchor diameter; 3) increasing number of anchors.

### 6.6.1.4 Concrete splitting failure

When a tensile load is applied to an anchor, it creates radial forces that induces tension in the concrete. As a result, if the tensile load exceeds the tensile strength of the concrete, it can cause the concrete to split or crack around the anchor. Splitting failure can occur for two reasons: 1) during installation; and 2) due to loading.

1. **Splitting failure during installation** can occur when installation torque is applied, and the expansion force generated by anchors causes concrete to crack/split. Proper anchor selection, drilling techniques and installation procedures (refer to [Chapter 8](#)), and adequate thickness of base material are essential to avoid this situation.

**Note:** This failure can be avoided by maintaining the following conditions as given in the relevant ETA: 1) minimum edge distance,  $c_{min}$  2) minimum spacing between anchors,  $s_{min}$  3) minimum base material thickness,  $h_{min}$ .

2. **Splitting failure due to loading** can also occur due to excessive loading.

Concrete splitting failure due to loading is checked for the required characteristic spacing,  $s_{cr,sp} = 2 c_{cr,sp}$  as given in relevant ETA.

Design check is not required if the minimum characteristic edge distance is maintained: for single anchor is  $c \geq 1.0 c_{cr,sp}$  and group of anchors,  $c \geq 1.2 c_{cr,sp}$  with depth as  $h \geq h_{min}$  ( $h_{min}$  corresponding to  $c_{cr,sp}$  as in ETA).

**Note:** If the characteristic resistances for concrete cone failure and pull-out failure (post-installed mechanical anchors) or combined pull-out and concrete failure (bonded anchors) are calculated for cracked concrete, and reinforcement resists the splitting forces by limiting the crack width to  $w_k \leq 0.3 \text{ mm}$ , no verification is needed. The reinforcement to avoid splitting failure should be placed symmetrically and close to an anchor (each fastener in case of group).

If detailed information is not available regarding requirement of reinforcement, the cross-section of the reinforcement,  $\Sigma A_{s,re}$ , to resist the splitting forces can be determined as follows:

$$\Sigma A_{s,re} = k_4 \cdot \frac{\Sigma N_{Ed}}{\frac{f_{yk,re}}{\gamma_{Ms,re}}} \quad \text{EC2-4, eq. (7.22)}$$

Table 6.6: Value of  $k_4$  for different types of anchor

	Deformation-controlled expansion anchors	Torque-controlled expansion anchor and bonded expansion anchors	Undercut anchors and concrete screws	Bonded anchors
$k_4$	2.0	1.5	1.0	0.5

$\Sigma N_{Ed}$  = the total design tensile force / actions on the fasteners.

$f_{yk,re}$  = the nominal yield strength of the reinforcing steel  $\leq 600 \text{ N/mm}^2$

If the above criteria is not fulfilled, the characteristic resistance of an anchor or a group shall be calculated according to formula provided below:

$$N_{Rk,sp} = N_{Rk,sp}^0 \cdot \frac{A_{c,N}}{A_{c,N}^0} \cdot \psi_{s,N} \cdot \psi_{re,N} \cdot \psi_{ec,N} \cdot \psi_{h,sp} \quad \text{EC2-4, eq. (7.23)}$$

$N_{Rk,sp}^0$  value is taken from relevant ETA.

$A_{c,N}, A_{c,N}^0, \psi_{s,N}, \psi_{re,N}, \psi_{ec,N}$  factors will be considered same as for concrete cone failure ([Section 6.6.1.2](#)), however the values  $c_{cr,N}$  and  $s_{cr,N}$  shall be replaced by  $c_{cr,sp}$  and  $s_{cr,sp}$ , respectively which correspond to the minimum member thickness  $h_{min}$ .

The influence of actual thickness of base material is taken care of by factor  $\psi_{h,sp}$ .

Considering higher thickness of base material, the value of  $\psi_{h,sp}$  can be increased up to a factor of 2.0. Hence if post-installed anchors are installed in a thicker concrete member, performance against splitting failure can be improved:

$$\psi_{h,sp} = \left( \frac{h}{h_{min}} \right)^{2/3} \leq \max \left\{ 1; \left( \frac{h_{ef} + 1.5c_1}{h_{min}} \right)^{2/3} \right\} \leq 2 \quad \text{EC2-4, eq. (7.24)}$$

**Note:** Effective strategies to increase the resistance against this failure mode are: 1) increasing edge distance and spacing between fasteners; 2) reducing the embedment depth; and 3) accepting that splitting cracks will happen and re-run the design assuming cracked concrete and accounting for sufficient reinforcement in the base material to limit their width.

### 6.6.1.5 Combined pull-out and concrete cone failure

This failure mode is applicable for bonded anchors only.

The characteristic resistance of a group of anchors,  $N_{Rk,p}$  is obtained from the given formula:

$$N_{Rk,p} = N_{Rk,p}^0 \cdot \frac{A_{p,N}}{A_{p,N}^0} \cdot \psi_{g,NP} \cdot \psi_{s,NP} \cdot \psi_{re,N} \cdot \psi_{ec,NP} \quad \text{EC2-4, eq. (7.13)}$$

The resistance for a single anchor not influenced by adjacent bonded fasteners or edges of the concrete member is defined by diameter, effective depth and bond resistance value.

$$N_{Rk,p}^0 = \psi_{sus} \cdot \tau_{Rk} \cdot \pi \cdot d \cdot h_{ef} \quad \text{EC2-4, eq. (7.14)}$$

$\tau_{Rk}$  is the bond resistance mentioned in the relevant ETA:  $\tau_{Rk,cr}$  for cracked concrete and  $\tau_{Rk,ucr}$  for uncracked concrete.

The impact due to sustained load on anchors is taken into account by the factor  $\psi_{sus}$ . This factor depends on the ratio between sustained loads (including permanent actions and permanent component of variable actions) and total loads at ULS. If this ratio ( $\alpha_{sus}$ ) is lesser than the product dependent factor that takes account of the influence of sustained load on the bond strength in ETA,  $\psi_{sus} = 1$  is used.

$$\psi_{sus} = 1 \text{ for } \alpha_{sus} \leq \psi_{sus}^0 \quad \text{EC2-4, eq. (7.14a)}$$

$$\psi_{sus} = \psi_{sus}^0 + 1 - \alpha_{sus} \text{ for } \alpha_{sus} \geq \psi_{sus}^0 \quad \text{EC2-4, eq. (7.14b)}$$

**Note:** The value of  $\alpha_{sus}$  depends on the load assumptions.

In absence of data of any product in ETA,  $\psi_{sus} = 0.6$ .

The geometric effect of axial spacing and edge distance on the characteristic resistance is taken into account by the value  $\frac{A_{p,N}}{A_{p,N}^0}$  using same expression as for concrete cone failure ([Section 6.6.1.2](#)).

The reference ideal bond influence area of an individual anchor is  $A_{p,N}^0 = s_{cr,Np} \cdot s_{cr,Np}$  where spacing  $s_{cr,Np}$  is influenced by bond resistance and sustained load factor of a specific product:

$$s_{cr,Np} = 7.3d \cdot (\psi_{sus} \cdot \tau_{Rk})^{0.5} \leq 3 \cdot h_{ef} \quad \text{EC2-4, eq. (7.15)}$$

Bond resistance,  $\tau_{Rk}$  is considered as  $\tau_{Rk,ucr}$  for uncracked concrete of class C20/25.

$A_{p,N}$  is the actual bond influence area, using actual spacing between adjacent fasteners ( $s \leq s_{cr,Np}$ ) and edge distance of the concrete member ( $c \leq c_{cr,Np}$ ).

Similar to concrete cone failure ([Section 6.6.1.2](#)), there are other influencing factors: closely spaced anchors ( $A_{p,N} / A_{p,N}^0$ ), uneven distribution in stress as a result of anchor placement near to an edge ( $\psi_{s,Np}$ ), spalling factor for reinforcement  $\psi_{re,Np}$ , eccentricity factor for different tension loads in anchor group  $\psi_{ec,Np}$  are calculated for this failure mode in the same manner as for concrete break-out failure. However,  $s_{cr,N}$  and  $c_{cr,N}$  are replaced by  $s_{cr,Np}$  and  $c_{cr,Np}$ .

In addition, the factor for group effect for closely spaced bonded anchors,  $\psi_{g,Np}$  is defined by following expressions:

$$\psi_{g,Np} = \psi_{g,Np}^0 - \left( \frac{s}{s_{cr,Np}} \right)^{0.5} \cdot (\psi_{g,Np}^0 - 1) \geq 1 \quad \text{EC2-4, eq. (7.17)}$$

$$\psi_{g,Np}^0 = \sqrt{n} - \sqrt{(n-1)} \cdot \left( \frac{\tau_{Rk}}{\tau_{Rk,cr}} \right)^{1.5} \geq 1 \quad \text{EC2-4, eq. (7.18)}$$

$$\tau_{Rk} = \frac{k_3}{\pi \cdot d} \cdot \sqrt{(h_{ef} \cdot f_{ck})} \quad \text{EC2-4, eq. (7.19)}$$

$k_3 = 7.7$  for cracked concrete,  $11.0$  for uncracked concrete.

### 6.6.1.6 Combined pull-out and concrete cone failure for hybrid (bonded concrete screw) system as per EOTA TR 075

The resistance against combined pull-out and concrete cone failure for bonded screw anchors are detailed in EOTA TR 075 [35] and depends on the resistance of screw anchor as well as the property of bonding material. The characteristic bond resistance  $\tau_{Rk}$  used given in the relevant equations of EC2-4 [1] for combined pull-out and concrete cone failure (as discussed in previous section) is replaced by the characteristic resistance  $N_{Rk,p,b}$  of the bonding component of bonded screws and applicable for both uncracked and cracked concrete.

**The combined resistance:** The characteristic combined pull-out and concrete cone resistance,  $N_{Rk,p,ucr/cr}$  for group of bonded screw anchors are derived calculating the resistance values of screw anchor and bonding element separately and then the group effect is considered by combining the two:

$$N_{Rk,p,ucr/cr} = N_{Rk,p,CS,ucr/cr} + \alpha_b \cdot N_{Rk,p,B,ucr/cr} \quad \text{EOTA TR 075, eqs. (1) and (12)}$$

$$\alpha_b = 1 - (1 - \varphi_{b,ucr/cr}) \cdot (s_{cr,Np} - s) / s_{cr,Np} \leq 1 \quad \text{EOTA TR 075, eqs. (3) and (13)}$$

The resistance of mechanical part (screw element) is defined by  $N_{Rk,p,CS,ucr/cr}$  and resistance of chemical part (bonding element) is defined by  $N_{Rk,p,B,ucr/cr}$ . Both resistances are combined using a factor,  $\varphi_{b,ucr/cr}$  to consider the contribution of bond property of bond material for uncracked/cracked concrete.

**Resistance of screw anchor:** The characteristic resistance of single concrete screw,  $N_{Rk,p,CS,ucr/cr}^0$  is taken from the relevant product ETA.

The resistance of concrete screw part in a group of anchors is calculated by the following equation:

$$N_{Rk,p,CS,ucr/cr} = n \cdot N_{Rk,p,CS,ucr/cr}^0 \cdot \psi_{ec,Np,CS} \quad \text{EOTA TR 075, eqs. (2) and (15)}$$

When different tension load acts on individual anchors in a group, the group effect is considered by the factor,  $\psi_{ec,Np,CS} = \frac{1}{1+2 \cdot (e_N/s)} \leq 1$  and  $e_N, s$  are calculated in the same way as mentioned in EC2-4 [1].  $n$  is the number of anchors in a group.

**Resistance of bonding element:** The characteristic resistance of bonding material  $N_{Rk,p,B,ucr/cr}^0$  for single anchor is taken from relevant product ETA.

The resistance of bonding material in a group of anchors is calculated by the following equation:

$$N_{Rk,p,B,ucr/cr} = N_{Rk,p,B,ucr/cr}^0 \cdot \frac{A_{p,N}}{A_{p,N}^0} \cdot \psi_{sus} \cdot \psi_{g,Np} \cdot \psi_{s,Np} \cdot \psi_{re,N} \cdot \psi_{ec,Np} \quad \text{EOTA TR 075, eqs. (5) and (16)}$$

$$\text{Sustained load factor } \psi_{sus} = 1.0 \text{ for } \alpha_{sus} \leq \psi_{sus}^0 \quad \text{EOTA TR 075 eqs. (6) and (17)}$$



$$\psi_{sus} = (\psi_{sus}^0 - \alpha_{sus} + \varphi_{b,ucr/cr}) / \varphi_{b,ucr/cr} \text{ for } \alpha_{sus} > \psi_{sus}^0 \quad \text{EOTA TR 075 eqs. (7) and (18)}$$

$\psi_{sus}^0$  is the factor which takes care of the effect of sustained load on bond strength of anchors and considered from product relevant ETA.

The factor ( $\varphi_{b,ucr/cr}$ ) for contribution of bond property in uncracked/cracked concrete is calculated using the following equation and the value is  $\leq 1.0$ :

$$\varphi_{b,ucr/cr} = N_{Rk,p,B,ucr}^0 / (N_{Rk,p,CS,ucr}^0 + N_{Rk,p,B,ucr}^0) \quad \text{EOTA TR 075, eqs. (4) and (14)}$$

The group effect of closely spaced anchors is considered by  $\psi_{g,Np}$  and calculated using the equation as follows:

$$\psi_{g,Np} = \psi_{g,Np}^0 - \left(\frac{s}{s_{cr,Np}}\right)^{0.5} \cdot (\psi_{g,Np}^0 - 1) \geq 1 \quad \text{EOTA TR 075, eqs. (9) and (19)}$$

$$\psi_{g,Np}^0 = \sqrt{n} - (\sqrt{n} - 1) \cdot \left(\frac{N_{Rk,p,B,ucr/cr}^0}{N_{Rk,c}}\right)^{1.5} \geq 1 \quad \text{EOTA TR 075, eqs. (10) and (20)}$$

$$N_{Rk,c} = k_3 \cdot h_{ef}^{1.5} \cdot \sqrt{f_{ck}} \quad \text{EOTA TR 075, eqs. (11) and (21)}$$

$$k_3 = k_{ucr,N} = 11.0 \text{ and } k_3 = k_{cr,N} = 7.7$$

The characteristic spacing is determined using the equation:

$$s_{cr,Np} = 4.1 \cdot \left( \psi_{sus} \cdot \frac{d}{h_{ef}} \cdot (N_{Rk,p,CS,ucr,c20/25}^0 + N_{Rk,p,B,ucr,c20/25}^0) \right)^{0.5} \leq 3h_{ef} \quad \text{EOTA TR 075, eq. (8)}$$

$d$  is the nominal diameter of concrete screw and  $N_{Rk,p,CS,ucr,c20/25}^0$  and  $N_{Rk,p,B,ucr,c20/25}^0$  are the characteristic resistances of screw part and bond element for single fastener in uncracked concrete of defined strength.

$A_{p,N}$  is the actual projected area and  $A_{p,N}^0$  is the ideal projected area of concrete cone.

$\psi_{s,Np}$  considers the effect of edge distance for the anchors loaded in tension,  $\psi_{re,N}$  is the factor which includes the effect of reinforcement located in concrete and  $\psi_{ec,Np}$  considers the eccentricity of load acting on a group of anchors.

### 6.6.1.7 Concrete blow-out failure

When a tensile load is applied to a post-installed anchor, it induces radial tension forces in the concrete around the anchor. These forces cause the concrete to pull away or "blow-out" from the anchor, resulting in a loss of load-bearing capacity. This type of failure typically happens when the anchor is installed close to an edge.

This failure needs to be checked only for post-installed undercut anchors acting as headed fasteners if the edge distance  $c \leq (0.5 \cdot h_{ef})$ . For groups of anchors arranged perpendicular to the edge verification is only required for the fasteners closest to the edge.

Resistance against blow-out failure is derived using the following equation:

$$N_{Rk,cb} = N_{Rk,cb}^0 \cdot \frac{A_{c,Nb}}{A_{c,Nb}^0} \cdot \psi_{s,Nb} \cdot \psi_{g,Nb} \cdot \psi_{ec,Nb} \quad \text{EC2-4, eq. (7.25)}$$

The characteristic resistance of a single anchor, not influenced by adjacent fasteners or further edges:

$$N_{Rk,cb}^0 = k_5 \cdot c_1 \cdot \sqrt{A_h} \cdot \sqrt{f_{ck}} \quad \text{EC2-4, eq. (7.26)}$$

Where,  $k_5$  is a factor depends on the crack condition of concrete: 8.7 for cracked concrete and 12.2 for uncracked concrete.  $A_h$  is as defined in eq. (7.12) of EC2-4 [1] or given in the relevant ETA.

The reference projected area for an individual anchor with an edge distance  $c_1$ :

$$A_{c,Nb}^0 = 4c_1^2 \quad \text{EC2-4, eq. (7.27)}$$

$A_{c,Nb}$  is the actual projected area and calculated using a similar way as for cone and combined failure (refer to Fig. 6.17).

The factor takes account of the disturbance of the distribution of stresses in the concrete due to proximity of edges:

$$\psi_{s,Nb} = 0.7 + 0.3 \cdot \left(\frac{c_2}{2c_1}\right) \leq 1 \quad \text{EC2-4, eq. (7.28)}$$

Factor  $\psi_{g,Nb}$  accounts for the group effect of the number of anchors in a row parallel to the edge:

$$\psi_{g,Nb} = \sqrt{n} + 1 - \sqrt{n} \cdot \left(\frac{s_2}{4c_1}\right) \geq 1 \text{ with } s_2 \leq 4c_1 \quad \text{EC2-4, eq. (7.29)}$$

The factor responsible for eccentricity of tension loads,  $\psi_{ec,Nb}$ :

$$\psi_{ec,Nb} = \left(\frac{1}{1+2 \cdot \frac{e_N}{4c_1}}\right) \leq 1 \quad \text{EC2-4, eq. (7.30)}$$

**Note:** To avoid this failure, edge distance needs to be increased.

### 6.6.1.8 Checklist to improve an anchor's performance against tension-related failure modes

Some features which influence the resistance of post-installed anchors are highlighted in Table 6.7. The table shows how the increase of different parameters may impact the resistance to specific failure modes.

Table 6.7: Summary of factors influencing resistance of anchors for tension load

Parameters \ Failure mode	Steel	Concrete cone	Pull-out	Combined pull-out and concrete cone	Concrete splitting	Concrete blow-out
Number of anchors	↑	●	↑	↑	●	●
Diameter of anchor	↑	●	↑	↑	●	●
Spacing of anchors	●	↑	●	↑	↑	↑
Edge distance	●	↑	●	↑	↑	↑
Effective depth	●	↑	●	↑	↓	●
Steel strength	↑	●	●	●	●	●
Strength of concrete	●	↑	↑	↑	↑	↑
Thickness of concrete	●	●	●	●	↑	●
Bond strength of anchor	●	●	●	↑	↑	●
Load eccentricity	●	↓	●	↓	↓	↓

**Legend:**

- ↑ Factors have positive impact on resistance, hence the value needs to be increased to achieve higher resistance
- ↓ Factors have negative impact on resistance, hence the value needs to be reduced to achieve higher resistance
- Factors do not have any impact on resistance

## 6.6.2 Verifications for anchors under shear loading

Required verifications for post-installed anchors in shear as per EC2-4 [1], are shown in Table 6.8. The design shear load  $V_{Ed}$  must be smaller than resistance value  $V_{Rd}$  (refer to [Section 6.1](#)). steel failure with or without lever arm (resistance  $V_{Ed}^h$ ) is checked for the most loaded anchor. The remaining concrete related failure modes are checked for group of anchors considering all related boundary conditions.

Table 6.8: Failure modes and criteria against shear load in EC2-4 [1]

Failure mode	Single anchor	Group of anchors	
		Most loaded anchor	Group
Steel failure of anchor without lever arm	$V_{Ed} \leq V_{Rd,s} = \frac{V_{Rk,s}}{\gamma_{Ms}}$	$V_{Ed}^h \leq V_{Rd,s} = \frac{V_{Rk,s}}{\gamma_{Ms}}$	
Steel failure of anchor with lever arm	$V_{Ed} \leq V_{Rd,s,M} = \frac{V_{Rk,s,M}}{\gamma_{Ms}}$	$V_{Ed}^h \leq V_{Rd,s,M} = \frac{V_{Rk,s,M}}{\gamma_{Ms}}$	
Concrete pry-out failure	$V_{Ed} \leq V_{Rd,cp} = \frac{V_{Rk,cp}}{\gamma_{Mc}}$		$V_{Ed}^g \leq V_{Rd,cp} = \frac{V_{Rk,cp}}{\gamma_{Mc}}$
Concrete edge failure	$V_{Ed} \leq V_{Rd,c} = \frac{V_{Rk,c}}{\gamma_{Mc}}$		$V_{Ed}^g \leq V_{Rd,c} = \frac{V_{Rk,c}}{\gamma_{Mc}}$

Relevant partial factors for shear resistance of anchors are shown in Table 6.9.

Table 6.9: Partial factors for shear in static loading

Failure mode	Partial safety factor	Reference value
Steel	$\gamma_{Ms}$	$1.0 \cdot \frac{f_{uk}}{f_{yk}} \geq 1.25$ for $f_{uk} \leq 800 \text{ MPa}$ and $\frac{f_{uk}}{f_{yk}} \leq 0.8$ $1.5$ for $f_{uk} > 800 \text{ MPa}$ and $\frac{f_{uk}}{f_{yk}} > 0.8$
Concrete pry-out	$\gamma_{Mc}$	$\gamma_c \cdot \gamma_{inst}$ ( $\gamma_{inst}$ is taken from ETA and $\gamma_c = 1.5^*$ )
Concrete edge break-out	$\gamma_{Mc}$	$\gamma_c \cdot \gamma_{inst}$ ( $\gamma_{inst}$ is taken from ETA and $\gamma_c = 1.5^*$ )

\*) If not otherwise specified in the applicable National Annex of EC2-4

### 6.6.2.1 Steel failure without lever arm

Shear failure without a lever arm for post-installed fasteners refers to a scenario where the anchor fails due to shear forces acting on it.

The characteristic resistance of a single anchor  $V_{Rk,s}^0$  is given in the relevant ETA.

For anchors with a cross section constant along the entire length,  $V_{Rk,s}^0$  is calculated by following equation:

$$V_{Rk,s}^0 = k_6 \cdot A_s \cdot f_{uk} \quad \text{EC2-4, eq. (7.34)}$$

$k_6$  factor depends on the ultimate strength of steel,  $f_{uk} \cdot k_6$  is 0.6 for  $f_{uk} \leq 500 \text{ MPa}$  and 0.5 for  $500 \leq f_{uk} \leq 1000 \text{ MPa}$ .  $A_s$  is the stressed cross section of an anchor.

When the ratio between effective depth and diameter  $h_{ef}/d \leq 5$  for concrete compressive strength class  $\leq C20/25$ ,  $V_{Rk,s}^0$  must be multiplied by a factor of 0.8.

The characteristic resistance of an anchor  $V_{Rk,s}$  is valid for a possible grout layer with a thickness  $t_{grout} \leq d/2$  is:

$$V_{Rk,s} = k_7 \cdot V_{Rk,s}^0 \quad \text{EC2-4, eq. (7.35)}$$

$k_7=1$  for single fastener and for group of fasteners,  $k_7$  is taken from ETA.

If the above condition is not satisfied,  $V_{Rk,s}$  is to be reduced as follows:

$$V_{Rk,s} = (1 - 0.01 \cdot t_{grout}) \cdot k_7 \cdot V_{Rk,s}^0 \quad \text{EC2-4, eq. (7.36)}$$

This equation is valid only in uncracked concrete and when the grout thickness is less than 40 mm.

**Note:** To increase the resistance against this failure mode: 1) select a more resistant steel material; 2) increase the diameter of the anchor; 3) increase the number of anchors.

### 6.6.2.2 Steel failure with lever arm

When the shear force is acting with a lever arm, the anchors experience an additional tension force arising from the bending moment. Therefore, the characteristic resistance for shear with lever arm is influenced by the moment generated ( $M_{Rk,s}$ ) and degree of restraint of anchor ( $\alpha_M$ ) at the side of fixture.

The characteristic resistance of a single anchor  $V_{Rk,s,M}$  is calculated from following equation:

$$V_{Rk,s,M} = \frac{\alpha_M \cdot M_{Rk,s}}{l_a} \quad \text{EC2-4, eq. (7.37)}$$

( $\alpha_M = 1.0$ ) if there is no restraint and it is assumed that the fixture can rotate freely (refer to Fig. 6.14).

( $\alpha_M = 2.0$ ) if there is full restraint and it is assumed that the fixture cannot rotate freely (refer to Fig. 6.14).

$l_a$  is the lever arm and mainly calculated according to Fig. 6.15 a) and b).

If the washer and nut are directly clamped to concrete surface and grout layer (strength  $\geq 30 \text{ N/mm}^2$ ) with thickness  $t_{grout} \leq d/2$ , then  $a_3=0$  (refer to Fig. 6.15 a) and b)).

$$M_{Rk,s} = M_{Rk,s}^0 \cdot \left(1 - \frac{N_{Ed}}{N_{Rd,s}}\right) \quad \text{EC2-4, eq. (7.38)}$$

$M_{Rk,s}^0$  is the characteristic bending resistance of a single anchor.

**Note:** The design provisions for shear with lever arm of EC2-4 [1] are not valid for near edge conditions and do not distinguish between grouted vs. ungrouted stand-off applications. Check the SOFA method explained in [Section 6.5.2](#) to address these design conditions accounting for the state of the art research on the topic.

### 6.6.2.3 Concrete pry-out failure

This failure mode corresponds to the formation of a concrete break-out opposite to the loading direction under shear loading. It may occur when a group of short anchors is placed far away from edges.

For mechanical post-installed anchors, the characteristic resistance  $V_{Rk,cp}$  is calculated as follows:

$$V_{Rk,cp} = k_8 \cdot N_{Rk,c} \quad \text{EC2-4, eq. (7.39 a)}$$

For post-installed bonded anchors,  $V_{Rk,cp}$  shall be calculated as follows:

$$V_{Rk,cp} = k_8 \cdot \min \{N_{Rk,c}; N_{Rk,p}\} \quad \text{EC2-4, eq. (7.39 c)}$$

$k_8$  is a factor to be taken from the relevant ETA.  $N_{Rk,c}$  is determined as per [Section 6.6.1.2](#) and  $N_{Rk,p}$  is determined as per [Section 6.6.1.3](#).

**Note:** Pry-out failure is dependent on the resistance value for cone break-out and pull-out failure. Hence, if resistance for those failure modes can be increased, resistance against pry-out will also be higher.

#### 6.6.2.4 Concrete edge failure

A concrete edge failure may occur under shear load when the anchors are close to the edges.

**Note:** This failure mode needs to be checked only for fasteners with edge distance  $c \leq \max(10h_{ef}; 60d)$  in the direction of shear load. This verification does not apply if shear load acts with the lever arm. Anchors located nearest to the edge are verified for edge failure and if there is more than one edge, checking is required for all the edges.

The characteristic resistance  $V_{Rk,c}$  of an anchor or a group of fasteners loaded towards the edge is:

$$V_{Rk,c} = V_{Rk,c}^0 \cdot \frac{A_{c,v}}{A_{c,v}^0} \cdot \psi_{\alpha,v} \cdot \psi_{h,v} \cdot \psi_{s,v} \cdot \psi_{ec,v} \cdot \psi_{re,v} \quad \text{EC2-4, eq. (7.40)}$$

Characteristic resistance of single anchor,  $V_{Rk,c}^0$  is defined as below:

$$V_{Rk,c}^0 = k_v \cdot d_{nom}^\alpha \cdot l_f^\beta \cdot \sqrt{f_{ck}} \cdot c^{1.5} \quad \text{EC2-4, eq. (7.41)}$$

The factor  $k_v$  is 1.7 for cracked concrete and 2.4 for uncracked concrete. The powers  $\alpha$  and  $\beta$  depend on edge distance ( $c_1$ ), depth ( $l_f$ ), and diameter of anchors ( $d_{nom}$ ):

$$\alpha = 0.1 \cdot \left(\frac{l_f}{c_1}\right)^{0.5} \quad \text{EC2-4, eq. (7.42)}$$

$$\beta = 0.1 \cdot \left(\frac{d_{nom}}{c_1}\right)^{0.2} \quad \text{EC2-4, eq. (7.43)}$$

**Note:** The value of  $l_f$  is mentioned in relevant ETA.

The ratio  $\frac{A_{c,v}}{A_{c,v}^0}$  takes into account the geometrical effect of spacing.  $A_{c,v}^0$  is the reference projected area:

$$A_{c,v}^0 = 4.5 c_1^2 \quad \text{EC2-4, eq. (7.44)}$$

$A_{c,v}$  is the actual area of concrete break-out body of the anchorage towards the lateral concrete surface. It is curtailed through the overlaps of the individual break-out bodies of neighboring anchorages and calculated depending on conditions;  $s < 3c_1$ ,  $c_2 < 1.5 c_1$ ,  $h < 1.5c_1$ . Refer to Fig. 6.20.

The edge influence is accounted by a factor  $\psi_{s,v}$  and calculated by following equation:

$$\psi_{s,v} = 0.7 + 0.3 \cdot \left(\frac{c_2}{1.5c_1}\right) \leq 1.0 \quad \text{EC2-4, eq. (7.45)}$$

Concrete edge resistance does not decrease proportionally with the thickness of the base material, hence this is taken care of by a factor,  $\psi_{h,v}$ :

$$\psi_{h,v} = \sqrt{\left(\frac{1.5c_1}{h}\right)} \geq 1.0 \quad \text{EC2-4, eq. (7.46)}$$

It depends on the value of edge distance perpendicular to the edge ( $c_1$ ) and thickness of concrete ( $h$ ). The effect of eccentricity ( $e_V$ ) in distribution of shear load in a group of anchors is considered by factor  $\psi_{ec,V}$ :

$$\psi_{ec,V} = \frac{1}{\left(1 + \frac{2 \cdot e_V}{3 \cdot c_1}\right)} \leq 1.0 \quad \text{EC2-4, eq. (7.47)}$$

For a design check of more than one edge, the angle between the applied shear load and the relevant edge is considered by a factor  $\psi_{\alpha,V}$ :

$$\psi_{\alpha,V} = \frac{1}{\sqrt{(\cos \alpha_V)^2 + (0.5 \sin \alpha_V)^2}} \leq 1.0 \quad \text{EC2-4, eq. (7.48)}$$

$\alpha_V$  is the angle between design shear load  $V_{Ed}$  (single anchor) or  $V_{Ed}^g$  (group anchors) and a line perpendicular to the verified edge. (Refer to Fig. 6.19).

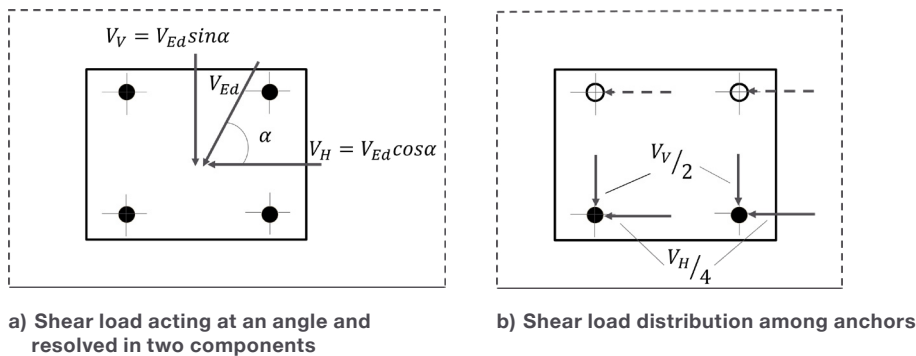

Fig. 6.19: Shear load with an inclination

The effect of edge reinforcement with respect to concrete condition is accounted for using factor  $\psi_{re,V}$ .  $\psi_{re,V} = 1.0$  for anchorages in uncracked or cracked concrete without edge reinforcement.

$\psi_{re,V} = 1.4$  for anchorages in cracked concrete with edge reinforcement ( $d_s \geq 12 \text{ mm}$ ) and closely spaced stirrups (spacing  $a \leq 100 \text{ mm}$  and  $a \leq 2c_1$ ).

**Note:**  $\psi_{re,V}$  can be considered greater than 1 only if  $h_{ef}$  is greater than 2.5 times concrete cover of edge reinforcement.

If anchors are placed in thin concrete with  $c_{2,max} \leq 1.5 c_1$  and  $h \leq 1.5c_1$ ,  $c_1$  is replaced by following expression:

$$c'_1 = \max \left\{ \frac{c_{2,max}}{1.5}; \frac{h}{1.5} \right\} \text{ in case of single anchors} \quad \text{EC2-4, eq. (7.49)}$$

$$c'_1 = \max \left\{ \frac{c_{2,max}}{1.5}; \frac{h}{1.5}; \frac{s_{2,max}}{3} \right\} \text{ in case of groups} \quad \text{EC2-4, eq. (7.50)}$$

$c_{2,max}$  is the larger of the two distances to the edges parallel to the direction of loading; and  $s_{2,max}$  is the maximum spacing in direction 2 between anchors within a group.

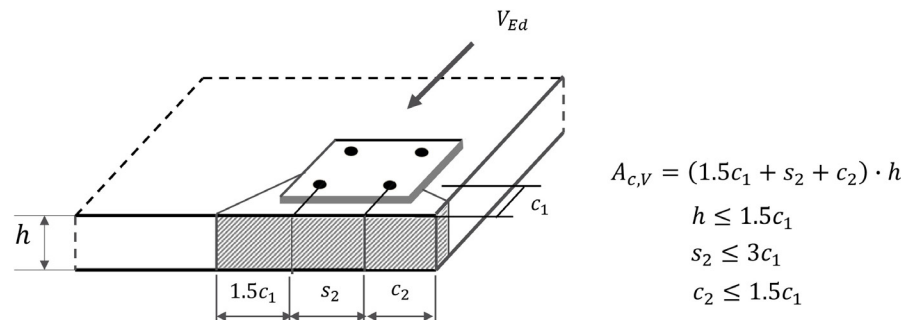

Fig. 6.20: Examples of actual projected areas  $A_{c,V}$  of the idealized concrete break-out bodies

**Note:** The resistance against this failure can be improved by increasing: 1) the edge distance for first row of anchors; 2) the embedment depth of anchors; 3) the spacing between anchors in a group; and 4) diameter of anchors.

### 6.6.2.5 Checklist to improve an anchor's performance against shear related failure modes

Some features which influence the resistance of post-installed anchors are highlighted in Table 6.10. The table shows how different parameters may impact the resistance to specific failure modes.

Table 6.10: Summary of influencing factors for shear resistance of post-installed anchors

Parameters \ Failure mode	Steel (shear without lever arm)	Steel (shear with lever arm)	Concrete pry-out	Concrete edge
Number of anchors	↑	↑	●	●
Diameter of anchor	↑	↑	●	↑
Spacing of anchors	●	●	↑	↑
Edge distance	●	●	↑	↑
Effective depth	●	●	↑	↑
Steel strength	↑	↑	●	●
Strength of concrete	●	●	↑	↑
Thickness of concrete	●	●	●	↑
Load eccentricity	●	●	↓	↓

#### Legend:

- ↑ Factors have positive impact on resistance, hence the value needs to be increased to achieve higher resistance
- ↓ Factors have negative impact on resistance, hence the value needs to be reduced to achieve higher resistance
- Factors do not have any impact on resistance

## 6.7 Design considering supplementary reinforcement as per EC2-4

In many cases concrete break-out is decisive under tension or shear loading. To increase the resistance in such conditions, properly designed supplementary reinforcement or unloaded reinforcement in an existing member can be taken into account. In general, such reinforcement can be utilized to resist tension or shear loading only, i.e., not both loading directions simultaneously. In the following sections the verification equations and the required detailing of supplementary reinforcement are explained.

### 6.7.1 Supplementary reinforcement designed for resistance against tension load

When designing the post-installed anchorages with supplementary reinforcement, **concrete cone break-out does not need to be checked if the supplementary reinforcement is designed to resist the total load**. This supplementary reinforcement needs to comply with the following:

- The reinforcement shall consist of ribbed reinforcing bars and detailed as stirrups or loops with a mandrel diameter  $\phi_m$  according to EC2-1-1 [27]. The reinforcements with a diameter  $\phi \leq 16 \text{ mm}$  must have  $f_{yk,re} \leq 600 \text{ N/mm}^2$ .
- If supplementary reinforcement is designed for the most loaded anchor, the same reinforcement shall be provided around all anchors.
- The effect of eccentricity related to the angle of failure cone can be minimized by using supplementary reinforcement as close as possible to the anchors. The recommended distance between reinforcement and anchor is  $\leq 0.75 h_{ef}$ .
- Anchorage length in the concrete failure cone,  $l_1$  is also defined for reinforcement as follows:
  - Anchorage with bends, hooks, or loops:  $l_1 \geq 4\phi$
  - Anchorage with straight bars, with or without welded transverse bars:  $l_1 \geq 10\phi$

Supplementary reinforcement is designed as per the strut-and-tie model, an approach which is used to analyze and design structures when complex load paths and discontinuities are present. It involves creating simplified diagrams of tension and compression forces which fulfil the equilibrium condition.

The supplementary reinforcement must be anchored outside the assumed failure cone with an anchorage length  $l_{bd}$  (refer to Fig. 6.21) according to EC2-1-1 [27]. Concrete cone failure assuming an embedment length corresponding to the end of the supplementary reinforcement shall be verified using the same formula (refer to [Section 6.6.1.2](#)) for  $N_{Rk,c}$ .

To resist the forces as analyzed from the strut-and-tie model and splitting forces (refer to [Section 6.6.1.4](#)) surface reinforcement is recommended to be provided, see Fig. 6.21.

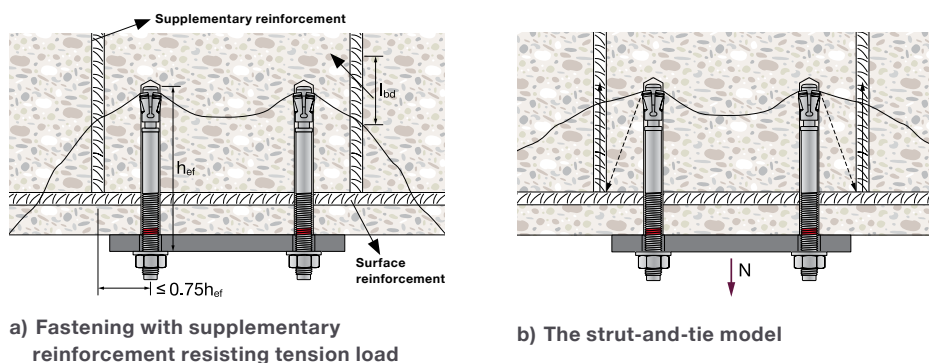

Fig. 6.21: Supplementary reinforcement with post-installed anchors

#### 6.7.1.1 Steel failure

The characteristic yield resistance of the supplementary reinforcement for one anchor is:

$$N_{Rk,re} \leq \sum_{i=1}^{n_{re}} A_{s,re,i} \cdot f_{yk,re}, \text{ where } f_{yk,re} \leq 600 \text{ N/mm}^2 \quad \text{EC2-4, eq. (7.31)}$$

$n_{re}$  is the number of bars of supplementary reinforcement effective for one anchor and  $A_{s,re}$  = area of supplementary reinforcement.



**Note:** Steel failure resistance of the supplementary reinforcement can be increased by using larger diameter of reinforcement and higher steel strength.

### 6.7.1.2 Anchorage failure

The anchorage resistance of the supplementary reinforcement,  $N_{Rd,a}$  is defined by below equation:

$$N_{Rd,a} \leq \sum_{i=1}^{n_{re}} N_{Rd,ai}^0 \quad \text{EC2-4, eq. (7.32)}$$

The resistance for single reinforcement,  $N_{Rd,a}^0$  is influenced by anchorage length ( $l_1$ ), bond strength ( $f_{bd}$ ), diameter of reinforcement ( $\phi$ ) and other factors ( $\alpha_1, \alpha_2$ ).

$$N_{Rd,a}^0 = \frac{(l_1 \cdot \pi \cdot \phi \cdot f_{bd})}{(\alpha_1 \cdot \alpha_2)} \leq A_{s,re} \cdot f_{yk,re} \cdot 1/\gamma_{Ms,re} \quad \text{EC2-4, eq. (7.33)}$$

**Note:**  $f_{bd}$  and  $\alpha_1, \alpha_2$  are considered according to EC2-1-1, sect. 8.4.2 and 8.4.4.

**Note:** By using larger diameter, deeper anchorage length and higher bond strength, anchorage failure resistance of the supplementary reinforcement against cone failure for fasteners can be improved.

### 6.7.2 Supplementary reinforcement designed for resistance against shear load

While designing the post-installed anchorages with supplementary reinforcement, **concrete edge failure does not need to be checked if supplementary reinforcement is designed to resist the total load.**

The requirement of shear supplementary reinforcement is the same as tension load case as defined in [Section 6.7.1](#). The shear supplementary reinforcement is arranged after analyzing with the strut-and-tie model as explained for tension loading. As a simplification, an angle of the compression struts of 45° may be assumed (Fig. 6.22).

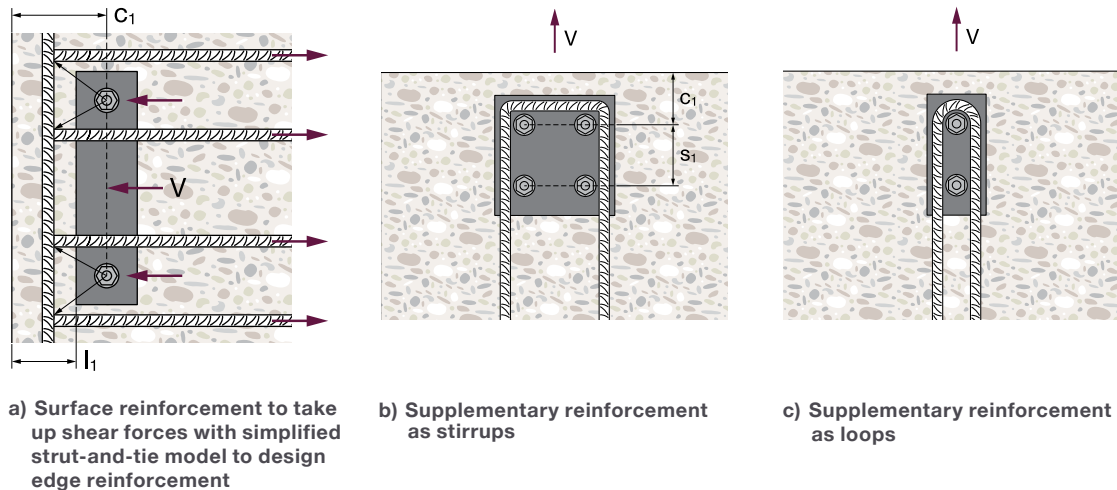

Fig. 6.22: Shear supplementary reinforcement for anchors

#### 6.7.2.1 Steel failure

The characteristic resistance of supplementary reinforcement for one anchor in case of steel failure is:

$$N_{Rk,re} \leq k_{10} \cdot \sum_{i=1}^{n_{re}} A_{s,re,i} \cdot f_{yk,re}, \text{ where } f_{yk,re} \leq 600 \text{ N/mm}^2 \quad \text{EC2-4, eq. (7.51)}$$

$k_{10}$  is the efficiency factor,  $k_{10} = 1.0$  surface reinforcement according to Fig. 6.22 a) and  $k_{10} = 0.5$  supplementary reinforcement as stirrups or loops enclosing the anchor (refer to Fig. 6.22 b) and Fig. 6.22 c)).

### 6.7.2.2 Anchorage failure

If supplementary reinforcement is provided as stirrups or loops in contact with anchor, design check for capacity of reinforcement in assumed and concrete break-out body is not required (refer to Fig. 6.22 b) and Fig. 6.22 c)).

The anchorage resistance of the supplementary reinforcement for a single fastener against concrete edge failure:

$$N_{Rd,a} \leq \sum_{i=1}^{n_{re}} N_{Rd,ai}^0 \quad \text{EC2-4, eq. (7.52)}$$

$$\text{Where, } N_{Rd,a}^0 = \frac{(l_1 \cdot \pi \cdot \Phi \cdot f_{bd})}{(\alpha_1 \cdot \alpha_2)} \leq A_{s,re} \cdot f_{yk,re} \cdot 1/\gamma_{Ms,re} \quad \text{EC2-4, eq. (7.53)}$$

## 6.8 Interaction between tension and shear loading

Post-installed anchors experiencing both tension and shear loading must be verified for combined action as per EC2-4 [1] provisions.

The design verification is done separately for steel failure and for failures other than steel by the equations mentioned in Table 6.11 and Fig. 6.23.

Table 6.11: Verification against combined action

Failure mode	Verification
Steel	$\left(\frac{N_{Ed}}{N_{Rd,s}}\right)^2 + \left(\frac{V_{Ed}}{V_{Rd,s}}\right)^2 \leq 1$
Failure mode other than steel	$\left(\frac{N_{Ed}}{N_{Rd,i}}\right)^{1.5} + \left(\frac{V_{Ed}}{V_{Rd,i}}\right)^{1.5} \leq 1$ or $\frac{N_{Ed}}{N_{Rd,i}} + \frac{V_{Ed}}{V_{Rd,i}} \leq 1.2$ and $\frac{N_{Ed}}{N_{Rd,i}} \leq 1$ and $\frac{V_{Ed}}{V_{Rd,i}} \leq 1$ , largest value $\frac{N_{Ed}}{N_{Rd,i}}$ and $\frac{V_{Ed}}{V_{Rd,i}}$ for different failure modes must be considered
Failure mode other than steel (supplementary reinforcement)	$\left(\frac{N_{Ed}}{N_{Rd,i}}\right)^{k_{11}} + \left(\frac{V_{Ed}}{V_{Rd,i}}\right)^{k_{11}} \leq 1$ , $k_{11} = 2/3$ or is given in the relevant ETA

**Note:** When shear load is applied with lever arm, steel failure verification is not required.

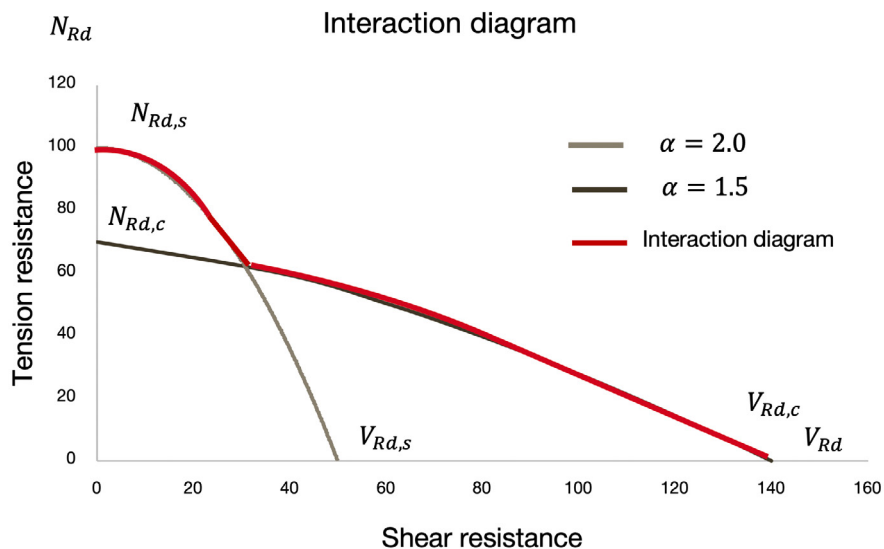

Fig. 6.23: Interaction between tension and shear diagram

## 6.9 Design example of post-installed anchors for static loading

### 6.9.1 Design for static loading without supplementary reinforcement

#### 6.9.1.1 Design example for mechanical expansion anchors

Project requirement: An IPBv 120/HE 120 M is attached to a concrete slab with steel baseplate. The connection is established using mechanical anchors (Fig. 6.24).

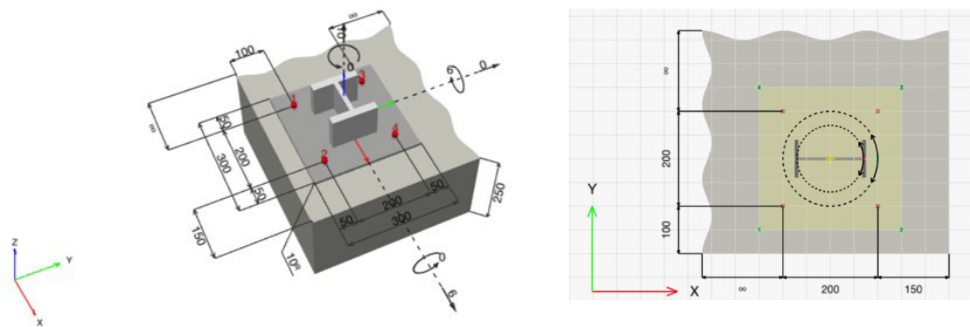

Fig. 6.24: Baseplate connection using post-installed mechanical anchors

Relevant project information:

Geometry of concrete:	Slab thickness, $h = 250 \text{ mm}$
Geometry of baseplate:	Plate dimension, $l \times w = 300 \times 300 \text{ mm}$
	Plate thickness, $t = 15 \text{ mm}$
Materials:	Normal weight concrete C25/30, cracked
	Surface reinforcement with spacing of 200 mm
Loading:	Tension force, $N_{Ed} = 10 \text{ kN}$
	Bending moment, $M_{Ed} = 6 \text{ kNm}$
	Shear, $V_{Ed} = 6 \text{ kN}$ (no stand-off)
Steel profile:	IPBv 120 /HE 120 M
Design working life:	50 years

Details of post-installed anchors:

Type of anchor:	Mechanical
No of anchors:	4
Spacing between anchors in X	200 mm
Spacing between anchors in Y	200 mm
Edge distance along X	150 mm
Edge distance along Y	100 mm

Installation condition of post-installed anchors:

Drilling method/orientation:	Rotary-hammer drilling/horizontal, dry
Installation/in-service temp.:	24°C (long term)/40°C (short term)
Corrosion resistance:	Anchors will be exposed in marine corrosive environment
System/solution choice:	Hilti HST4-R metal expansion anchor (ETA-21/0878 [36])

1) Analysis of tension forces:

Moment acting on anchor group,  $M_{Ed} = 6 \text{ kNm}$ , is divided in tension and compression among all anchors. For this, the neutral axis is calculated and the force on each anchor is analyzed and shown in Fig. 6.25. Total tension force on anchor group,  $N_{Ed} = 32.5 \text{ kN}$ .

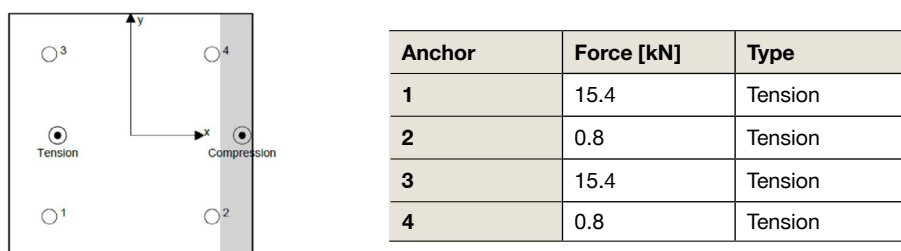

Fig. 6.25: Force analysis of anchors

2) Analysis of shear forces:

Total shear force acting on anchor group is  $V_{Ed} = 6 \text{ kN}$ . It is distributed among all four anchors for steel and pry-out verification. For concrete edge verification it is distributed only between the near edge row of anchors considered based on the principles shown in Fig. 6.9 and Fig. 6.10, considering the edges parallel and perpendicular to the acting shear, respectively.

3) Details of proposed anchor: The proposed anchor solution is defined in Table 6.12.

Table 6.12: Anchor properties

Type of anchor	Mechanical	
Specification of anchor	HST4-R	
Diameter of anchor	$d$	16 mm
Effective embedment depth	$h_{ef}$	115 mm
Nominal embedment depth	$h_{nom}$	128 mm



Design verifications are carried considering rigid baseplate as per EC2-4 [1] and characteristic resistances are taken from ETA-21/0878 [36]. For a details on the calculations of resistances against the different failure modes please refer to [Section 6.6](#).

### Check of tension load failures:

#### Steel failure:

The resistance against steel failure is calculated for the most stressed anchor using the following equation:

$$N_{Rd,s} = \frac{N_{Rk,s}}{\gamma_{M,s}} \quad \text{EC2-4, Table 7.1}$$

$$N_{Rk,s} = 75 \text{ kN} \quad \text{ETA-21/0878, Table C1}$$

$$N_{Rd,s} = \left( \frac{75}{1.4} \right) = 53.6 \text{ kN} > N_{Ed}^h = 15.4 \text{ kN} \quad \text{verification fulfilled } \checkmark$$

#### Pull-out failure:

The resistance against pull-out failure is calculated for the highest loaded anchor by the following expression,

$$N_{Rd,p} = \frac{\psi_c \cdot N_{Rk,p}}{\gamma_{M,p}} \quad \text{EC2-4, Table 7.1}$$

$$\psi_c = 1.118 \quad \text{influence of concrete strength for C25/30, ETA-21/0878, Table C1}$$

$$N_{Rk,p} = 38 \text{ kN} \quad \text{ETA-21/0878, Table C1}$$

$$\gamma_{M,p} = 1.5 \quad \text{ETA-21/0878, Table C1}$$

$$N_{Rd,p} = \left( \frac{1.118 \cdot 38}{1.5} \right) = 28.3 \text{ kN} > N_{Ed}^h = 15.4 \text{ kN} \quad \text{verification fulfilled } \checkmark$$

#### Concrete cone failure:

The resistance against concrete cone failure is checked for the entire anchor group with following equation:

$$N_{Rd,c} = \frac{N_{Rk,c}}{\gamma_{Mc}} \quad \text{EC2-4, Table 7.1}$$

$$N_{Rk,c}^0 = k_1 \cdot \sqrt{f_{ck}} \cdot h_{ef}^{1.5} = 8.9 \cdot \sqrt{25} \cdot 115^{1.5} = 54.9 \text{ kN} \quad \text{ETA-21/0878, Table C1 and EC2-4, eq. (7.2)}$$

$$s_{cr,N} = 2 \cdot c_{cr,N} = 3 \cdot h_{ef} = (3 \cdot 115) = 345 \text{ mm}, c_{cr,N} = 172.5 \text{ mm} \quad \text{EC2-4, sect. 7.2.1.4 (3)}$$

$$A_{c,N} = (100 + 200 + 172.5) \cdot (150 + 200 + 172.5) = 246,881 \text{ mm}^2 \quad \text{EC2-4, Fig. 7.4}$$

$$A_{c,N}^0 = s_{cr,N} \cdot s_{cr,N} = (345 \cdot 345) = 119,025 \text{ mm}^2; \quad \text{EC2-4, eq. (7.3)}$$

$$\psi_{s,N} = 0.7 + 0.3 \cdot \frac{c}{c_{cr,N}} = 0.7 + 0.3 \cdot \left( \frac{100}{172.5} \right) = 0.87 \leq 1.0 \quad \text{EC2-4, eq. (7.4)}$$

$$\psi_{re,N} = 0.5 + \frac{h_{ef}}{200} \leq 1.0 \quad \text{EC2-4, eq. (7.5)}$$

$$\psi_{re,N} = 1.0, \text{ Surface reinforcement with spacing of } 200 \text{ mm}$$

$$\psi_{ec,N} = \frac{1}{1 + \left( \frac{2 \cdot e_{c,N}}{s_{cr,N}} \right)} \quad \text{EC2-4, eq. (7.6)}$$

$$\text{Eccentricity along X axis } e_{c,N} = 89.8 \text{ mm}, \psi_{ec,N} = \frac{1}{1 + \left( \frac{2 \cdot 89.8}{345} \right)} = 0.66$$

$$\text{Eccentricity along Y axis } e_{c,N} = 0 \text{ mm}, \text{ hence } \psi_{ec,N} = 1.0$$

$$\text{Factor for bending moment, } \psi_{M,N} = 1.0 \text{ due to edge proximity} \quad \text{EC2-4, eq. (7.7)}$$

$$N_{Rk,c} = N_{Rk,c}^0 \cdot \frac{A_{c,N}}{A_{c,N}^0} \cdot \psi_{s,N} \cdot \psi_{re,N} \cdot \psi_{ec,N} \cdot \psi_{M,N} = 54.9 \cdot \left( \frac{246,881}{119,025} \right) \cdot 0.87 \cdot 1.0 \cdot 0.66 = 65.4 \text{ kN}$$

$$\gamma_{Mc} = 1.5$$

$$N_{Rd,c} = \left( \frac{65.4}{1.5} \right) = 43.6 \text{ kN} > N_{Ed} = 32.5 \text{ kN} \quad \text{verification fulfilled } \checkmark$$

### Concrete splitting failure:

With reference to the criteria given in EC2-4 [1], sect. 7.2.1.7 (2) b) 2), the splitting failure is resisted by reinforcement in concrete with limitation in crack width of  $w_k \leq 0.3 \text{ mm}$ .

### Check of shear load failures:

#### Steel failure:

The resistance against steel failure is calculated for the most stressed anchor using following equation:

$$V_{Rd,s} = \frac{V_{Rk,s}}{\gamma_{Ms}} \quad \text{EC2-4, Table 7.2}$$

$$\gamma_{Ms} = 1.25 \quad \text{ETA-21/0878, Table C2}$$

$$V_{Rk,s} = 72.4 \text{ kN} \quad \text{ETA-21/0878, Table C2}$$

$$V_{Rd,s} = \left( \frac{72.4}{1.25} \right) = 57.9 > V_{sd1} = 1.5 \text{ kN} \quad \text{verification fulfilled} \checkmark$$

#### Concrete pry-out failure:

The resistance against concrete pry-out failure is calculated for the group of anchors,

$$V_{Rk,cp} = k_8 \cdot N_{Rk,c} \quad \text{EC2-4, eq. (7.39a)}$$

$$V_{Rd,cp} = \frac{V_{Rk,cp}}{\gamma_{Mcp}} \quad \text{EC2-4, Table 7.2}$$

$$\gamma_{Mcp} = 1.5 \quad \text{ETA-21/0878, Table C2}$$

$$k_8 = 2.74 \quad \text{ETA-21/0878, Table C2}$$

The characteristic resistance of a single anchor is taken from the check of concrete cone failure:

$$N_{Rk,c}^0 = 54.9 \text{ kN}, \psi_{s,N} = 0.87, \psi_{re,N} = 1.0 \text{ [ same as concrete cone failure]}, \psi_{ec,N} = 1.0$$

$$N_{Rk,c} = N_{Rk,c}^0 \cdot \frac{A_{c,N}}{A_{c,N}^0} \cdot \psi_{s,N} \cdot \psi_{re,N} \cdot \psi_{ec,N} = 54.9 \cdot \frac{246,881}{119,025} \cdot 0.87 \cdot 1.0 \cdot 1.0 = 99 \text{ kN},$$

$$V_{Rk,cp} = 99 \cdot 2.74 = 271.3 \text{ kN}$$

$$V_{Rd,cp} = \left( \frac{271.3}{1.5} \right) = 180.8 \text{ kN} > V_{Ed} = 6 \text{ kN} \quad \text{verification fulfilled} \checkmark$$

#### Concrete edge failure: shear acting parallel to edge in Y'-direction

The resistance against the concrete edge is checked for the shear force parallel to the left edge in the direction of Y', force is acting on all anchors.

$$V_{Rd,c} = \frac{V_{Rk,c}}{\gamma_{Mc}} \quad \text{EC2-4, Table 7.2}$$

$$\gamma_{Mc} = 1.5 \quad \text{ETA-21/0878, Table C2}$$

$$l_f = h_{ef} = 115 \text{ mm}, c_1 = 100 \text{ mm}, c_2 = 150 \text{ mm}, k_v = 1.7 \text{ for cracked concrete}$$

$$\alpha = 0.1 \cdot \left( \frac{l_f}{c_1} \right)^{0.5} = 0.1 \cdot \left( \frac{115}{100} \right)^{0.5} = 0.11 \quad \text{EC2-4, eq. (7.42)}$$

$$\beta = 0.1 \cdot \left( \frac{d_{nom}}{c_1} \right)^{0.2} = 0.1 \cdot \left( \frac{16}{100} \right)^{0.2} = 0.07 \quad \text{EC2-4, eq. (7.43)}$$

$$V_{Rk,c}^0 = k_v \cdot d_{nom}^\alpha \cdot l_f^\beta \cdot \sqrt{f_{ck}} \cdot c_1^{1.5} = 1.7 \cdot 16^{0.11} \cdot 115^{0.07} \cdot \sqrt{25} \cdot 100^{1.5} = 15.9 \text{ kN} \quad \text{EC2-4, eq. (7.41)}$$

$$A_{c,v}^0 = 4.5 c_1^2 = 4.5 \cdot 100^2 = 45,000 \text{ mm}^2 \quad \text{EC2-4, eq. (7.44)}$$

$$A_{c,v} = (150 + 200 + 1.5 \cdot 100) \cdot (1.5 \cdot 100) = 75,000 \text{ mm}^2$$

$$\psi_{s,v} = 0.7 + 0.3 \cdot \left( \frac{c_2}{1.5c_1} \right) \leq 1.0 = 0.7 + 0.3 \cdot \left( \frac{150}{1.5 \cdot 100} \right) = 1.0$$

$$\psi_{h,v} = 1.0, \psi_{ec,v} = 1.0, \psi_{\alpha,v} = 2.0 \text{ for } \alpha_v = 90^\circ$$

$$V_{Rk,c} = V_{Rk,c}^0 \cdot \frac{A_{c,V}}{A_{c,V}^0} \cdot \psi_{\alpha,V} \cdot \psi_{h,v} \cdot \psi_{s,V} \cdot \psi_{ec,V} \cdot \psi_{re,V} = 15.9 \cdot \frac{75,000}{45,000} \cdot 2.0 \cdot 1.0 \cdot 1.0 \cdot 1.0 \cdot 1.0 = 53 \text{ kN}$$

$$V_{Rd,c} = \left( \frac{53}{1.5} \right) = 35.3 \text{ kN} > V_{Ed} = 6 \text{ kN}$$

verification fulfilled ✓

### Concrete edge failure: shear acting perpendicular to edge in $X^+$ -direction (decisive edge)

The resistance against the edge is checked for the shear force perpendicular to the bottom edge in the direction of  $X^+$ , the force is acting on front anchors.

$$V_{Rd,c} = \frac{V_{Rk,c}}{\gamma_{Mc}} \quad \text{EC2-4, Table 7.2}$$

$$\gamma_{Mc} = 1.5 \quad \text{ETA-21/0878, Table C2}$$

$l_f = h_{ef} = 115 \text{ mm}$ ,  $c_1 = 150 \text{ mm}$ ,  $c_2 = 100 \text{ mm}$ ,  $k_v = 1.7$  for cracked concrete

$$\alpha = 0.1 \cdot \left( \frac{l_f}{c_1} \right)^{0.5} = 0.1 \cdot \left( \frac{115}{150} \right)^{0.5} = 0.088 \quad \text{EC2-4, eq. (7.42)}$$

$$\beta = 0.1 \cdot \left( \frac{d_{nom}}{c_1} \right)^{0.2} = 0.1 \cdot \left( \frac{16}{150} \right)^{0.2} = 0.064 \quad \text{EC2-4, eq. (7.43)}$$

$$V_{Rk,c}^0 = k_v \cdot d_{nom}^\alpha \cdot l_f^\beta \cdot \sqrt{f_{ck}} \cdot c_1^{1.5} = 1.7 \cdot 16^{0.088} \cdot 115^{0.064} \cdot \sqrt{25} \cdot 150^{1.5} = 26.9 \text{ kN} \quad \text{EC2-4, eq. (7.41)}$$

$$A_{c,V}^0 = 4.5 c_1^2 = 4.5 \cdot 150^2 = 101,250 \text{ mm}^2 \quad \text{EC2-4, eq. (7.44)}$$

$$A_{c,V} = (100 + 200 + 1.5 \cdot 150) \cdot (1.5 \cdot 150) = 118,125 \text{ mm}^2$$

$$\psi_{s,V} = 0.7 + 0.3 \cdot \left( \frac{c_2}{1.5 c_1} \right) \leq 1.0 = 0.7 + 0.3 \cdot \left( \frac{100}{1.5 \cdot 150} \right) = 0.833$$

$$\psi_{h,v} = 1.0, \psi_{ec,V} = 1.0, \psi_{\alpha,V} = 1.0$$

$$V_{Rk,c} = V_{Rk,c}^0 \cdot \frac{A_{c,V}}{A_{c,V}^0} \cdot \psi_{\alpha,V} \cdot \psi_{h,v} \cdot \psi_{s,V} \cdot \psi_{ec,V} \cdot \psi_{re,V} = 26.3 \cdot \frac{118,125}{101,250} \cdot 1.0 \cdot 1.0 \cdot 0.833 \cdot 1.0 \cdot 1.0$$

$$V_{Rk,c} = 26.2 \text{ kN}$$

$$V_{Rd,c} = \left( \frac{26.2}{1.5} \right) = 17.5 \text{ kN} > V_{Ed} = 6 \text{ kN}$$

verification fulfilled ✓

### Check for combined tension and shear load:

Steel failure: EC2-4, Table 7.3

$$\text{Ratio between action load and resistance in tension, } \beta_N = \left( \frac{15.4}{53.6} \right) = 0.28 \leq 1.0$$

$$\text{Ratio between action load and resistance in shear, } \beta_v = \left( \frac{1.5}{57.9} \right) = 0.03 \leq 1.0$$

$$\beta_N^\alpha + \beta_v^\alpha = 0.28^2 + 0.03^2 = 0.08 \leq 1$$

verification fulfilled ✓

Failure other than steel: EC2-4, Table 7.3

$$\text{Ratio between action load and resistance in tension, } \beta_N = \left( \frac{32.5}{43.6} \right) = 0.75 \leq 1.0$$

$$\text{Ratio between action load and resistance in shear, } \beta_v = \left( \frac{6}{17.5} \right) = 0.34 \leq 1.0$$

$$\beta_N^\alpha + \beta_v^\alpha = 0.75^{1.5} + 0.34^{1.5} = 0.85 \leq 1.$$

verification fulfilled ✓

### 6.9.1.2 Design example for concrete screw anchor

Project requirement: Handrails are connected to concrete through baseplate using post-installed screw anchors (Fig. 6.26).

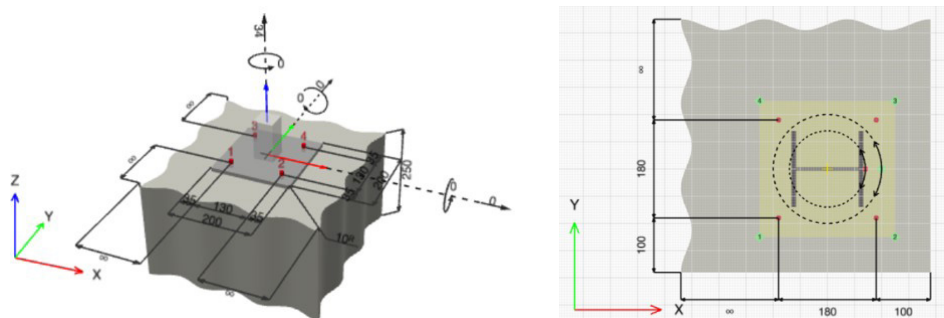

Fig. 6.26: Baseplate connection using post-installed concrete screw anchors

Relevant project information:

Geometry of concrete:	Slab thickness, $h = 250 \text{ mm}$
Geometry of baseplate:	Plate dimension, $l \times w = 200 \times 200 \text{ mm}$ Plate thickness, $t = 20 \text{ mm}$
Materials:	Normal weight concrete C20/25, cracked Surface reinforcement with spacing $200 \text{ mm}$
Loading:	Tension force, $N_{Ed} = 34 \text{ kN}$
Steel profile:	Square bar for handrail, $50 \times 50 \text{ mm}$
Design working life:	50 years

Details of post-installed anchors:

Type of anchor:	Mechanical
No of anchors:	4
Spacing between anchors in X	130 mm
Spacing between anchors in Y	130 mm

Installation condition of post-installed anchors:

Drilling method/orientation:	Rotary-hammer drilling/horizontal, dry
Installation/in-service temp.:	24°C (long term)/40°C (short term)
System/solution choice:	Hilti HUS4-H metal expansion anchor (ETA-20/0867 [37])

4) Analysis of tension forces:

Total tension force on anchor group,  $N_{Ed} = 34 \text{ kN}$  will be equally distributed among all anchors (Fig. 6.27).

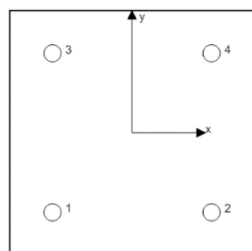

Anchor	Force [kN]	Type
1	8.5	Tension
2	8.5	Tension
3	8.5	Tension
4	8.5	Tension

Fig. 6.27: Force analysis of anchors



5) Details of proposed anchor: The proposed anchor solution is defined in Table 6.13.

Table 6.13: Anchor properties

Type of anchor	Mechanical	
Specification of anchor	HUS4-H	
Diameter of anchor	$d$	10 mm
Effective embedment depth	$h_{ef}$	68 mm
Nominal embedment depth	$h_{nom}$	90 mm



Design verifications are carried considering rigid baseplate as per EC2-4 [1] and characteristic resistances are taken from ETA-20/0867 [37]. For a details on the calculations of resistances against the different failure modes please refer to [Section 6.6](#).

Check of tension load failures:

Steel failure:

The resistance against steel failure is calculated for the most stressed anchor using the following equation:

$$N_{Rd,s} = \frac{N_{Rk,s}}{\gamma_{M,s}} \quad \text{EC2-4, Table 7.1}$$

$$N_{Rk,s} = 55 \text{ kN} \quad \text{ETA-20/0867, Table C1}$$

$$N_{Rd,s} = \left( \frac{55}{1.4} \right) = 36.7 \text{ kN} > N_{Ed}^h = 8.5 \text{ kN} \quad \text{verification fulfilled} \checkmark$$

Pull-out failure:

The resistance against pull-out failure is calculated for the highest loaded anchor by the following expression:

$$N_{Rd,p} = \frac{\psi_c \cdot N_{Rk,p}}{\gamma_{M,p}} \quad \text{EC2-4, Table 7.1}$$

$$\psi_c = 1.0 \quad \text{influence of concrete strength for C20/25, ETA-20/0867, Table C1}$$

$$N_{Rk,p} \geq N_{Rk,c}^0 = 15.8 \text{ kN} \quad \text{ETA-20/0867, Table C1}$$

$$N_{Rk,c}^0 = k_1 \cdot \sqrt{f_{ck}} \cdot h_{ef}^{1.5} = 7.7 \cdot \sqrt{20} \cdot 68^{1.5} = 19.3 \text{ kN} \quad \text{ETA-20/0867, Table C1 and EC2-4, eq. (7.2)}$$

$$\gamma_{M,p} = 1.5 \quad \text{ETA-20/0867, Table C1}$$

$$N_{Rd,p} = \left( \frac{1.0 \cdot 19.3}{1.5} \right) = 12.9 \text{ kN} > N_{Ed}^h = 8.5 \text{ kN} \quad \text{verification fulfilled} \checkmark$$

Concrete cone failure:

The resistance against concrete cone failure is checked for the entire anchor group with following equation:

$$N_{Rd,c} = \frac{N_{Rk,c}}{\gamma_{Mc}} \quad \text{EC2-4, Table 7.1}$$

$$N_{Rk,c}^0 = k_1 \cdot \sqrt{f_{ck}} \cdot h_{ef}^{1.5} = 7.7 \cdot \sqrt{20} \cdot 68^{1.5} = 19.3 \text{ kN} \quad \text{ETA-20/0867, Table C1 and EC2-4, eq. (7.2)}$$

$$s_{cr,N} = 2 \cdot c_{cr,N} = 3 \cdot h_{ef} = (3 \cdot 68) = 204 \text{ mm}, c_{cr,N} = 102 \text{ mm} \quad \text{EC2-4, sect. 7.2.1.4 (3)}$$

$$A_{c,N} = 111,556 \text{ mm}^2 \quad \text{EC2-4, Fig. 7.4}$$

$$A_{c,N}^0 = s_{cr,N} \cdot s_{cr,N} = (204 \cdot 204) = 41,616 \text{ mm}^2 \quad \text{EC2-4, eq. (7.3)}$$

$$\psi_{s,N} = 0.7 + 0.3 \cdot \frac{c}{c_{cr,N}} \leq 1.0 \quad \text{EC2-4, eq. (7.4)}$$

$$\psi_{re,N} = 0.5 + \frac{h_{ef}}{200} \leq 1.0 \quad \text{EC2-4, eq. (7.5)}$$

$\psi_{re,N} = 1.0$ , Surface reinforcement with spacing of 200 mm.

$$\psi_{ec,N} = \frac{1}{1 + \left(\frac{2 \cdot e_{c,N}}{s_{cr,N}}\right)} \quad \text{EC2-4, eq. (7.6)}$$

Eccentricity along X and Y axis  $e_{c,N} = 0 \text{ mm}$ , hence  $\psi_{ec,N} = 1.0$

Factor for bending moment,  $\psi_{M,N} = 1.0$  EC2-4, eq. (7.7)

$$N_{Rk,c} = N_{Rk,c}^0 \cdot \frac{A_{c,N}}{A_0} \cdot \psi_{s,N} \cdot \psi_{re,N} \cdot \psi_{ec,N} \cdot \psi_{M,N} = 19.3 \cdot \left(\frac{111,556}{41,616}\right) \cdot 1.0 \cdot 1.0 \cdot 1.0 = 51.7 \text{ kN}$$

$$\gamma_{Mc} = 1.5$$

$$N_{Rd,c} = \left(\frac{51.7}{1.5}\right) = 34.5 \text{ kN} > N_{Ed} = 34 \text{ kN} \quad \text{verification fulfilled} \checkmark$$

Concrete splitting failure:

With reference to the criteria given in EC2-4 [1], sect. 7.2.1.7 (2) b) 2), the splitting failure is resisted by reinforcement in concrete with limitation in crack width of  $w_k \leq 0.3 \text{ mm}$ .

Check for utilization:

Steel failure: EC2-4, Table 7.3

$$\text{Ratio between action load and resistance in tension, } \beta_N = \left(\frac{8.5}{36.7}\right) = 0.24 \leq 1 \quad \text{verification fulfilled} \checkmark$$

Failure other than steel: EC2-4, Table 7.3

$$\text{Ratio between action load and resistance in tension, } \beta_N = \left(\frac{34}{34.5}\right) = 0.99 \leq 1 \quad \text{verification fulfilled} \checkmark$$

Due to the update in design of the structural elements, the tension force has increased by 15% and the revised tension force is  $N_{Ed} = 39 \text{ kN}$ . Now the existing HUS4-H screw anchors can't be used as the utilization ratio is higher than 100%. The anchors have been taken out and requirement has been set for replacing these with an anchor solution with better performance and reusability. The design has been checked for the hybrid screw anchor system (Table 6.14).

Table 6.14: Anchor properties

Type of anchor	Hybrid	
Specification of anchor	HUS4-MAX capsule	
Diameter of anchor	$d$	10 mm
Effective embedment depth	$h_{ef} = h_{nom}$	85 mm



**Note:** For retrofitting application German National approval Z-21.8-2137 [38] is followed.

Total tension force on anchor group,  $N_{Ed} = 39 \text{ kN}$  will be equally distributed among all anchors (Fig. 6.28).

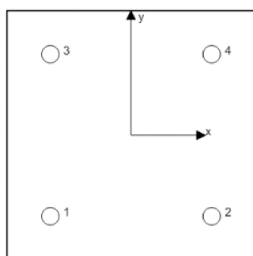

Anchor	Force [kN]	Type
1	9.75	Tension
2	9.75	Tension
3	9.75	Tension
4	9.75	Tension

Fig. 6.28: Force analysis of anchors

Design verifications are carried considering rigid baseplate as per EC2-4 [1], EOTA TR 075 [35] and characteristic resistances are taken from ETA-18/1160 [39]. For a details on the calculations of resistances against the different failure modes please refer to [Section 6.6](#).

#### Check of tension load failures:

##### Steel failure:

The resistance against steel failure is calculated for the most stressed anchor using the following equation:

$$N_{Rd,s} = \frac{N_{Rk,s}}{\gamma_{M,s}} \quad \text{EC2-4, Table 7.1}$$

$$N_{Rk,s} = 55 \text{ kN} \quad \text{ETA-18/1160, Table C1}$$

$$N_{Rd,s} = \left(\frac{55}{1.5}\right) = 36.7 \text{ kN} > N_{Ed}^h = 9.75 \text{ kN} \quad \text{verification fulfilled } \checkmark$$

##### Combined pull-out and concrete cone failure:

The resistance against combined pull-out and concrete cone failure is checked for the entire anchor group with following equation:

$$N_{Rd,p} = \frac{N_{Rk,p}}{\gamma_{Mp}} \quad \text{EC2-4, Table 7.1}$$

$$N_{Rk,p,CS,cr}^0 = 19.3 \text{ kN} \quad \text{ETA-18/1160, Table C1}$$

$$\psi_{sus} = 1.0$$

$$N_{Rk,p,B,cr}^0 = 4.5 \text{ kN} \quad \text{ETA-18/1160, Table C1}$$

$$N_{Rk,c} = k_3 \cdot \sqrt{f_{ck}} \cdot h_{ef}^{1.5} = 7.7 \cdot \sqrt{20} \cdot 85^{1.5} = 26.9 \text{ kN} \quad \text{EOTA TR 075, eq. (21)}$$

$$s_{cr,Np} = 4.1 \cdot \left( \psi_{sus} \cdot \frac{d}{h_{ef}} \cdot (N_{Rk,p,CS,ucr,c20/25}^0 + N_{Rk,p,B,ucr,c20/25}^0) \right)^{0.5}$$

$$s_{cr,Np} = 4.1 \cdot \left( 1.0 \cdot \frac{10}{85} \cdot (27.6 + 10.4) \right)^{0.5} \leq 3 \cdot h_{ef} \quad \text{EOTA TR 075, eq. (8)}$$

$$s_{cr,Np} = 255 \text{ mm}, c_{cr,Np} = 127.5 \text{ mm}$$

$$A_{p,N} = 148,225 \text{ mm}^2 \quad \text{EC2-4, Fig. 7.4}$$

$$A_{p,N}^0 = s_{cr,Np} \cdot s_{cr,Np} = (255 \cdot 255) = 65,025 \text{ mm}^2; \quad \text{EC2-4, eq. (7.3)}$$

$$\psi_{g,Np}^0 = \sqrt{n} - \sqrt{(n-1)} \cdot \left( \frac{N_{Rk,p,B,ucr/cr}^0}{N_{Rk,c}} \right)^{1.5} \geq 1.0, \psi_{g,Np}^0 = 1.93 \quad \text{EOTA TR 075, eq. (20)}$$

$$\psi_{g,Np} = \psi_{g,Np}^0 - \left( \frac{s}{s_{cr,Np}} \right)^{0.5} \cdot (\psi_{g,Np}^0 - 1) \quad \text{EOTA TR 075, eq. (19)}$$

$$\psi_{g,Np} = 1.26$$

$$\psi_{s,Np} = 0.7 + 0.3 \cdot \frac{c}{c_{cr,N}} \leq 1.0 \quad \text{EC2-4, eq. (7.4)}$$

$$\psi_{re,Np} = 0.5 + \frac{h_{ef}}{200} \leq 1.0, \psi_{re,Np} = 1.0 \quad \text{EC2-4, eq. (7.5)}$$

$$\psi_{ec,Np} = \frac{1}{1 + \left( \frac{e_{c,N}}{s_{cr,N}} \right)} \quad \text{EC2-4, eq. (7.6)}$$

Eccentricity along X and Y axis  $e_{c,N} = 0 \text{ mm}$ , hence  $\psi_{ec,N} = 1.0$

Factor for bending moment,  $\psi_{M,N} = 1.0$

$$N_{Rk,p,B,ucr/cr} = N_{Rk,p,B}^0 \cdot \frac{A_{p,N}}{A_{p,N}^0} \cdot \psi_{g,Np} \cdot \psi_{s,Np} \cdot \psi_{re,Np} \cdot \psi_{ec,Np} = 4.5 \cdot \left( \frac{148,225}{65,025} \right) \cdot 1.26 \cdot 1.0 \cdot 1.0 \cdot 1.0 = 13 \text{ kN}$$

$$N_{Rk,p,CS,cr} = n \cdot N_{Rk,p,CS,cr}^0 \cdot \psi_{ec,Np,CS} = 4 \cdot 19.3 \cdot 1.0 = 77.3 \text{ kN} \quad \text{EOTA TR 075, eq. (15)}$$

$$\varphi_{b,ucr/cr} = N_{Rk,p,B,ucr}^0 / (N_{Rk,p,CS,ucr}^0 + N_{Rk,p,B,ucr}^0) = 4.5 / (19.3 + 4.5) = 0.19 \quad \text{EOTA TR 075, eq. (14)}$$

$$\alpha_b = 1 - (1 - \varphi_{b,cr}) \cdot (s_{cr,Np} - s) / s_{cr,Np} \quad \text{EOTA TR 075, eq. (13)}$$

$$\alpha_b = 1 - (1 - 0.19) \cdot (255 - 130) / 255 = 0.6$$

$$N_{Rk,p,ucr/cr} = N_{Rk,p,CS,ucr/cr} + \alpha_b \cdot N_{Rk,p,B,ucr/cr} = 77.3 + 0.6 \cdot 13.0 = 85.5 \text{ kN} \quad \text{EOTA TR 075, eq. (12)}$$

$$\gamma_{Mc} = 1.5$$

$$N_{Rd,c} = \left( \frac{85.5}{1.5} \right) = 57 \text{ kN} > N_{Ed} = 39 \text{ kN} \quad \text{verification fulfilled} \checkmark$$

#### Concrete cone failure:

The resistance against concrete cone failure is checked for the entire anchor group with following equation:

$$N_{Rd,c} = \frac{N_{Rk,c}}{\gamma_{Mc}} \quad \text{EC2-4, Table 7.1}$$

$$N_{Rk,c}^0 = k_1 \cdot \sqrt{f_{ck}} \cdot h_{ef}^{1.5} = 7.7 \cdot \sqrt{20} \cdot 85^{1.5} = 26.9 \text{ kN} \quad \text{ETA-20/0867, Table C1 and EC2-4, eq. (7.2)}$$

$$s_{cr,N} = 2 \cdot c_{cr,N} = 3 \cdot h_{ef} = (3 \cdot 85) = 255 \text{ mm}, c_{cr,N} = 127.5 \text{ mm} \quad \text{EC2-4, sect. 7.2.1.4 (3)}$$

$$A_{c,N} = 148,225 \text{ mm}^2 \quad \text{EC2-4, Fig. 7.4}$$

$$A_{c,N}^0 = s_{cr,N} \cdot s_{cr,N} = (255 \cdot 255) = 65,025 \text{ mm}^2; \quad \text{EC2-4, eq. (7.3)}$$

$$\psi_{s,N} = 0.7 + 0.3 \cdot \frac{c}{c_{cr,N}} \leq 1.0 \quad \text{EC2-4, eq. (7.4)}$$

$$\psi_{re,N} = 0.5 + \frac{h_{ef}}{200} \leq 1.0 \quad \text{EC2-4, eq. (7.5)}$$

$\psi_{re,N} = 1.0$ , Surface reinforcement with spacing of 200 mm.

$$\psi_{ec,N} = \frac{1}{1 + \left( \frac{2 \cdot e_{c,N}}{s_{cr,N}} \right)} \quad \text{EC2-4, eq. (7.6)}$$

Eccentricity along X and Y axis  $e_{c,N} = 0 \text{ mm}$ , hence  $\psi_{ec,N} = 1.0$

Factor for bending moment,  $\psi_{M,N} = 1.0$

$$N_{Rk,c} = N_{Rk,c}^0 \cdot \frac{A_{c,N}}{A_{c,N}^0} \cdot \psi_{s,N} \cdot \psi_{re,N} \cdot \psi_{ec,N} \cdot \psi_{M,N} = 26.9 \cdot \left( \frac{148,225}{65,025} \right) \cdot 1.0 \cdot 1.0 \cdot 1.0 \cdot 1.0 = 61.3 \text{ kN}$$

$$\gamma_{Mc} = 1.5$$

$$N_{Rd,c} = \left( \frac{61.3}{1.5} \right) = 41 \text{ kN} > N_{Ed} = 39 \text{ kN} \quad \text{verification fulfilled} \checkmark$$

#### Concrete splitting failure:

With reference to the criteria given in EC2-4 [1], sect. 7.2.1.7 (2) b) 2), the splitting failure is resisted by reinforcement in concrete with limitation in crack width of  $w_k \leq 0.3 \text{ mm}$ .

#### Check for utilization:

Steel failure: EC2-4, Table 7.3

$$\text{Ratio between action load and resistance in tension, } \beta_N = \left( \frac{9.75}{36.7} \right) = 0.27 \leq 1.0 \quad \text{verification fulfilled} \checkmark$$

Failure other than steel: EC2-4, Table 7.3

$$\text{Ratio between action load and resistance in tension, } \beta_N = \left( \frac{39}{41} \right) = 0.95 \leq 1.0 \quad \text{verification fulfilled} \checkmark$$

### 6.9.2 Design for static loading with supplementary reinforcement

Project requirement: An IPBi 140/HEA 140 A is attached to a concrete beam with steel baseplate. The connection is established using mechanical anchors (Fig. 6.29).

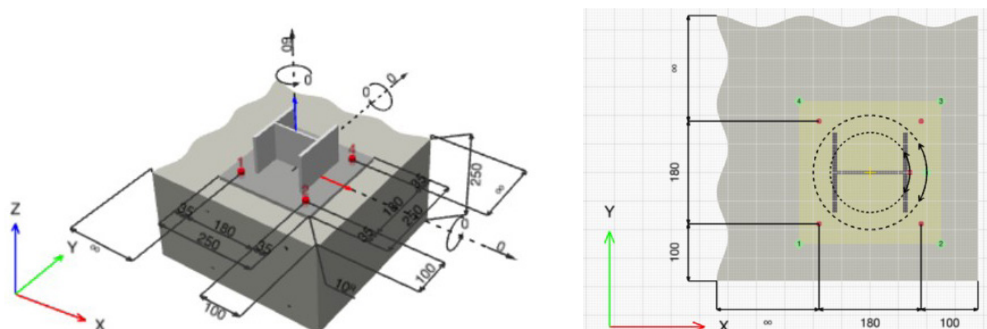

Fig. 6.29: Baseplate connection using post-installed mechanical anchors

#### Relevant project information:

Geometry of concrete:	Beam height, $h = 250 \text{ mm}$
Geometry of baseplate:	Plate dimension, $l \times w = 250 \times 250 \text{ mm}$ Plate thickness, $t = 20 \text{ mm}$
Materials:	Normal weight concrete C25/30, cracked Reinforcing steel $f_{yk} = 500 \text{ N/mm}^2$ Surface reinforcement with spacing of $100 \text{ mm}$ and diameter $\varnothing 12$
Loading:	Tension force, $N_{Ed} = 60 \text{ kN}$
Steel profile:	IPBi 140 /HEA 140 A
Design working life:	50 years

#### Details of post-installed anchors:

Type of anchor:	Mechanical
No of anchors:	4
Spacing between anchors in X	$180 \text{ mm}$
Spacing between anchors in Y	$180 \text{ mm}$
Edge distance along X	$100 \text{ mm}$
Edge distance along Y	$100 \text{ mm}$

#### Installation condition of post-installed anchors:

Drilling method/orientation:	Rotary-hammer drilling/horizontal, dry
Installation/in-service temp.:	$24^\circ\text{C}$ (long term)/ $40^\circ\text{C}$ (short term)
Design working life:	50 years
Corrosion resistance:	Anchors will be exposed in marine corrosive environment
System/solution choice:	Hilti HST4-R metal expansion anchor (ETA-21/0878 [36])

#### 1) Analysis of tension forces:

Total tension force on anchor group,  $N_{Ed} = 60 \text{ kN}$  will be equally distributed among all anchors (Fig. 6.30).

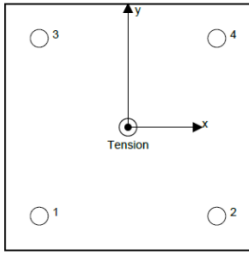

Anchor	Force [kN]	Type
1	15	Tension
2	15	Tension
3	15	Tension
4	15	Tension

Fig. 6.30: Force analysis of anchors

2) Details of proposed anchor: The proposed anchor solution is defined in Table 6.15.

Table 6.15: Anchor properties

Type of anchor	Mechanical	
Specification of anchor	HST4-R	
Diameter of anchor	$d$	16 mm
Effective embedment depth	$h_{ef}$	155 mm
Nominal embedment depth	$h_{nom}$	168 mm



Design verifications are carried considering rigid baseplate as per EC2-4 [1] and characteristic resistances are taken from ETA-21/0878 [36]. For a details on the calculations of resistances against the different failure modes please refer to [Section 6.7](#).

Check of tension load failures:

Steel failure:

The resistance against steel failure is calculated for the most stressed anchor using the following equation:

$$N_{Rd,s} = \frac{N_{Rk,s}}{\gamma_{M,s}} \quad \text{EC2-4, Table 7.1}$$

$$N_{Rk,s} = 75 \text{ kN} \quad \text{ETA-21/0878, Table C1}$$

$$N_{Rd,s} = \left(\frac{75}{1.4}\right) = 53.6 \text{ kN} > N_{Ed}^h = 15 \text{ kN} \quad \text{verification fulfilled} \checkmark$$

Pull-out failure:

The resistance against pull-out failure is calculated for the highest loaded anchor by the following expression:

$$N_{Rd,p} = \frac{\psi_c \cdot N_{Rk,p}}{\gamma_{M,p}} \quad \text{EC2-4, eq. (7.1)}$$

$$\psi_c = 1.118 \quad \text{influence of concrete strength for C25/30, ETA-21/0878, Table C1}$$

$$N_{Rk,p} = 38 \text{ kN} \quad \text{ETA-21/0878, Table C1}$$

$$\gamma_{M,p} = 1.5 \quad \text{ETA-21/0878, Table C1}$$

$$N_{Rd,p} = \left(\frac{1.118 \cdot 38}{1.5}\right) = 28.3 \text{ kN} > N_{Ed}^h = 15 \text{ kN} \quad \text{verification fulfilled} \checkmark$$

Concrete cone failure:

The resistance against concrete cone failure is checked for the entire anchor group with the following equation:

$$N_{Rd,c} = \frac{N_{Rk,c}}{\gamma_{Mc}} \quad \text{EC2-4, Table 7.1}$$

$$N_{Rk,c}^0 = k_1 \cdot \sqrt{f_{ck}} \cdot h_{ef}^{1.5} = 8.9 \cdot \sqrt{25} \cdot 155^{1.5} = 85.9 \text{ kN} \quad \text{ETA-21/0878, Table C1 and EC2-4, eq. (7.2)}$$

$$s_{cr,N} = 2 \cdot c_{cr,N} = 3 \cdot h_{ef} = (3 \cdot 155) = 465 \text{ mm}, c_{cr,N} = 232.5 \text{ mm} \quad \text{EC2-4, sect. 7.2.1.4 (3)}$$

$$A_{c,N} = (100 + 180 + 232.5) \cdot (100 + 180 + 232.5) = 262,656 \text{ mm}^2 \quad \text{EC2-4, Fig. 7.4}$$

$$A_{c,N}^0 = s_{cr,N} \cdot s_{cr,N} = (465 \cdot 465) = 216,225 \text{ mm}^2 \quad \text{EC2-4, eq. (7.3)}$$

$$\psi_{s,N} = 0.7 + 0.3 \cdot \frac{c}{c_{cr,N}} = 0.7 + 0.3 \cdot \left(\frac{100}{232.5}\right) = 0.83 \leq 1.0 \quad \text{EC2-4, eq. (7.4)}$$

$$\psi_{re,N} = 0.5 + \frac{h_{ef}}{200} \leq 1.0 \quad \text{EC2-4, eq. (7.5)}$$

$$\psi_{re,N} = 0.5 + \frac{155}{200} = 1.275 > 1.0$$

$$\psi_{ec,N} = \frac{1}{1 + \left(\frac{2 \cdot e_{c,N}}{s_{cr,N}}\right)} \quad \text{EC2-4, eq. (7.6)}$$

Eccentricity along X axis  $e_{c,N} = 0$  mm, hence  $\psi_{ec,N} = 1.0$

Eccentricity along Y axis  $e_{c,N} = 0$  mm, hence  $\psi_{ec,N} = 1.0$

$$\text{Factor for bending moment, } \psi_{M,N} = 1.0 \quad \text{EC2-4, eq. (7.7)}$$

$$N_{Rk,c} = N_{Rk,c}^0 \cdot \frac{A_{c,N}}{A_{c,N}^0} \cdot \psi_{s,N} \cdot \psi_{re,N} \cdot \psi_{ec,N} \cdot \psi_{M,N} = 85.9 \cdot \left(\frac{262,656}{216,225}\right) \cdot 0.83 \cdot 1.0 \cdot 1.0 \cdot 1.0 = 86.6 \text{ kN}$$

$$\gamma_{Mc} = 1.5$$

$$N_{Rd,c} = \left(\frac{86.6}{1.5}\right) = 57.7 \text{ kN} < N_{Ed} = 60 \text{ kN} \quad \text{verification not fulfilled } \otimes$$

Concrete splitting failure:

With reference to the criteria given in EC2-4 [1], sect. 7.2.1.7 (2) b) 2), the splitting failure is resisted by reinforcement in concrete with limitation in crack width of  $w_k \leq 0.3 \text{ mm}$ .

To resist concrete cone break-out failure, the available supplementary tension reinforcement is taken into account and the arrangement is shown in Fig. 6.31.

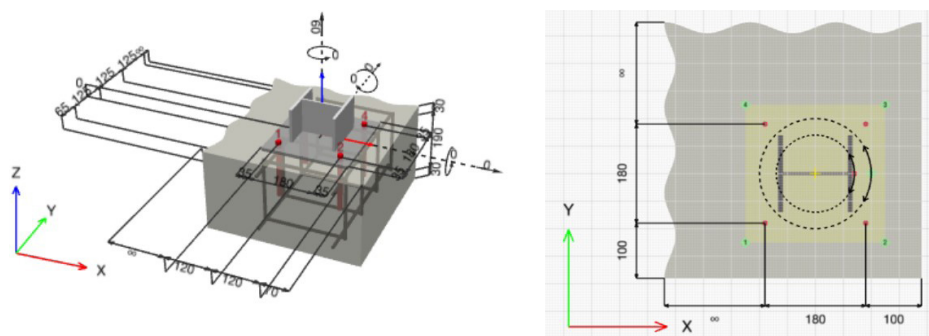

Fig. 6.31: Additional supplementary reinforcement in concrete base material

Supplementary reinforcement of diameter 10 mm in form of closed stirrups at spacing of 125 mm is used. Diameter of surface reinforcement is also 10 mm. Considering the strut-and-tie model as per EC2-4 [1], sect.7.2.1.2 and 7.2.1.9, forces on each member are as given in Table 6.16 in reference to the model shown in Fig. 6.32.

Table 6.16: Forces on supplementary reinforcement

Rebar	Type	Orientation	Tension force (kN)
Surface reinforcement	Straight	Horizontal	3.0
0	Closed stirrup	Vertical 1 (0-V1)	10.8
		Vertical 2 (0-V2)	10.8
		Horizontal (0-H)	4.3
1	Closed stirrup	Vertical 1 (1-V1)	8.4
		Vertical 2 (1-V2)	8.4
		Horizontal (1-H)	4.0
2	Closed stirrup	Vertical 1 (2-V1)	10.8
		Vertical 2 (2-V2)	10.8
		Horizontal (2-H)	4.3

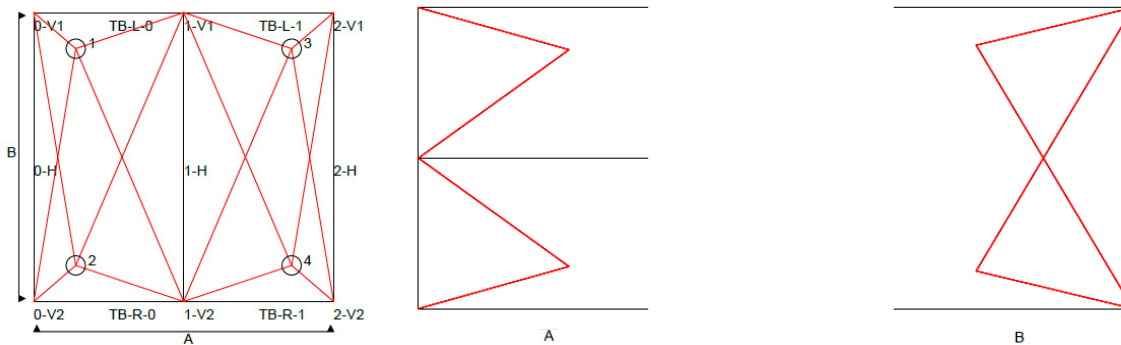

Fig. 6.32: Strut-and-tie model

Steel failure of longitudinal rebar:

The resistance against steel failure of longitudinal rebars are checked considering following equation:

$$N_{Rd,re} = \frac{N_{Rk,re}}{\gamma_{Ms,re}}$$

$$\gamma_{Ms,re} = 1.15$$

$$N_{Rk,re} = A_{s,re} \cdot f_{s,re}, A_{s,re} = 79 \text{ mm}^2 \text{ and } f_{s,re} = 500 \text{ MPa}, N_{Rk,re} = 79 \cdot 500 = 39.5 \text{ kN}$$

$$N_{Rd,re} = \left( \frac{39.5}{1.15} \right) = 34.4 \text{ kN} > N_{Ed,re} = 3 \text{ kN} \quad \text{verification fulfilled} \checkmark$$

**Note:** For shear loading, shear supplementary reinforcement is provided. Refer to Hilti PROFIS Engineering (Chapter 7).

Steel failure of supplementary reinforcement, horizontal:

$$N_{Rd,re} = \frac{N_{Rk,re}}{\gamma_{Ms,te}}$$

$$\gamma_{Ms,te} = 1.15$$

$$N_{Rk,re} = A_{s,re} \cdot f_{s,re}, A_{s,re} = 79 \text{ mm}^2 \text{ and } f_{s,re} = 500 \text{ MPa}, N_{Rk,re} = 79 \cdot 500 = 39.5 \text{ kN}$$

$$N_{Rd,re} = \left( \frac{39.5}{1.15} \right) = 34.4 \text{ kN} > N_{Ed,re} = 4 \text{ kN} \quad \text{verification fulfilled} \checkmark$$

Steel failure of supplementary reinforcement, vertical:

$$N_{Rd,re} = \frac{N_{Rk,re}}{\gamma_{Ms,te}}$$

$$\gamma_{Ms,te} = 1.15$$



$$N_{Rk,re} = A_{s,re} \cdot f_{s,re}, A_{s,re} = 79 \text{ mm}^2 \text{ and } f_{s,re} = 500 \text{ MPa}, N_{Rk,re} = 79 \cdot 500 = 39.5 \text{ kN}$$

$$N_{Rd,re} = \left( \frac{39.5}{1.15} \right) = 34.4 \text{ kN} > N_{Ed,re} = 8.4 \text{ kN} \quad \text{verification fulfilled } \checkmark$$

Reinforcement anchorage inside the break-out body vertical:

$$N_{Rd,a} = \frac{l_1 \cdot \pi \cdot d_{s,re} \cdot f_{bd}}{\alpha_1 \cdot \alpha_2}, l_1 = 70 \text{ mm}, d_{s,re} = 10 \text{ mm}, f_{bd} = 2.69 \text{ MPa}$$

$$\alpha_1 = 0.7, \alpha_2 = 1.0 \quad \text{EC2-1, sect. 8.4.2 and 8.4.4}$$

$$N_{Rd,a} = \left( \frac{70 \cdot \pi \cdot 10 \cdot 2.69}{0.7 \cdot 1.0} \right) = 8.5 \text{ kN} > N_{Ed,re} = 8.4 \text{ kN} \quad \text{verification fulfilled } \checkmark$$

## 6.10 Design against seismic actions as per EC2-4

As discussed in [Section 3.7](#), the performance of post-installed anchors is sensitive to conditions typical of seismic events, e.g., cyclic loading and large crack width. Therefore, the design of anchors in seismic prone areas must be treated accordingly. **Seismic events** are natural phenomena that may occur with lower or higher probability (risk) in specific geographical areas (Fig. 6.33). **Seismic hazard** (Fig. 6.33) is a factor of **seismic risk** that depends on ground acceleration during seismic events and **vulnerability** of the structure depends on the type of structure and importance class. **Seismic categories** are used to assess the potential of seismic hazard for structures and define the design with the aim of making structures anti-seismic. Seismic performance of anchors is categorized in two types: C1 and C2. C1 represents a generally low level of hazard whereas C2 indicates a higher level of seismic risk.

- **Performance category C1** provides anchor capacities only in terms of resistances at the ultimate limit state (maximum assumed crack width  $\Delta w = 0.5 \text{ mm}$ ).
- **Performance category C2** provides anchor capacities in terms of both resistances at the ultimate limit state and displacements at the damage limitation state and ultimate limit state (maximum assumed crack width  $\Delta w = 0.8 \text{ mm}$ ).

The requirements for category C2 are more stringent. The recommended seismic performance category is defined in EC2-4 [1] and applicable national regulations.

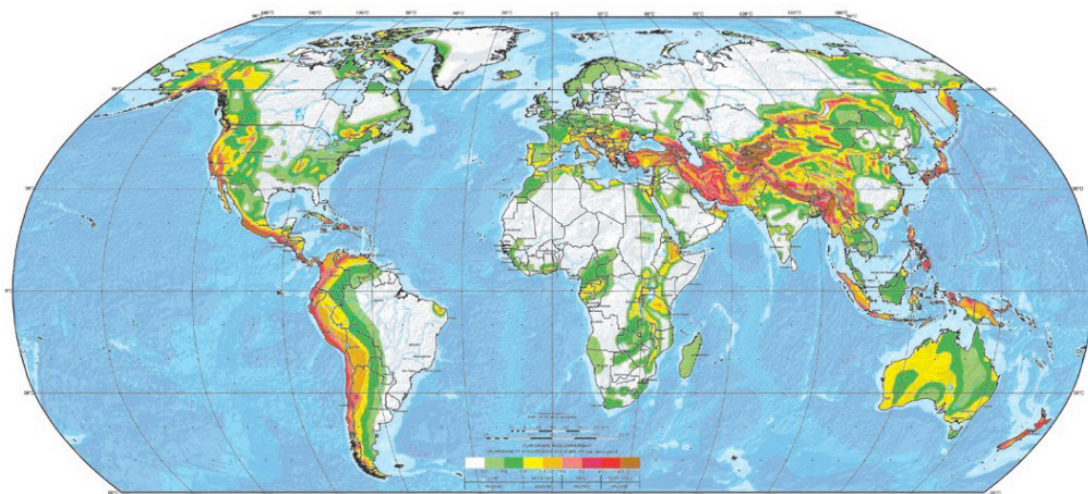

Fig. 6.33: Seismic hazard map. (Source: The Global Seismic Hazard Assessment Program, GSHAP).

In all cases, no anchors are allowed to be installed in areas of the concrete members where section plasticization is expected, i.e., in plastic hinges (see Fig. 6.34), because the crack width will likely exceed the limit of  $\Delta w = 0.8 \text{ mm}$ , for which the anchors are assessed.

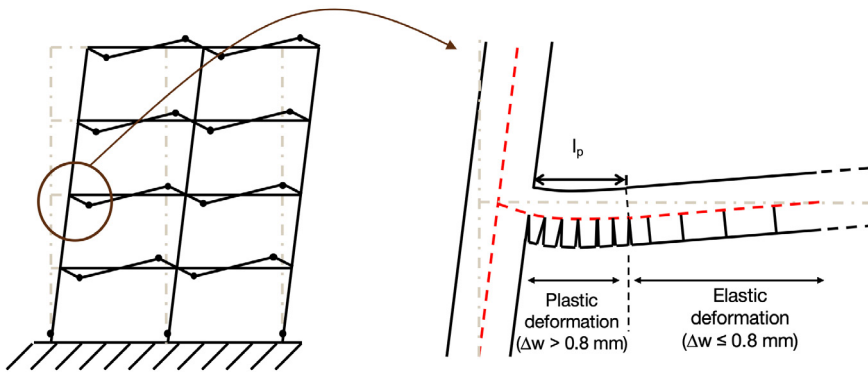

Fig. 6.34: Example of plastic and elastic portions of reinforced concrete members ( [4])

### 6.10.1 Determination of seismic actions

The design value of seismic actions is determined according to EC8-1 [40] and EC2-4 [1] Annex C considering all possible effects for vertical and horizontal ground motions for both structural and non-structural connections.

**Note:** Fastening with stand-off installation or with a layer of grout as  $\geq 0.5d$  are not covered by EC2-4 under seismic actions.

#### 6.10.1.1 Vertical seismic actions

Design seismic load for baseplate **structural applications (type-A)** is considered according to EC8-1 [40]. EC2-4 [1] includes the scope of calculation of design seismic load for **non-structural applications (type B)** as well. For type A connections, the vertical effect of seismic ground motion can be considered if design vertical ground acceleration,  $\alpha_{vg} > 2.5 \text{ m/s}^2$ . A typical model is presented in Fig. 6.35 to show the vertical effect of seismic action for type-B connections, including the application where gravity load is transferred through the direct bearing of a fixture on the structure.

The connection shown at point 1 requires including the vertical effect of seismic whereas connection 2 does not need to include the vertical effect if  $\alpha_{vg} < 2.5 \text{ m/s}^2$ .

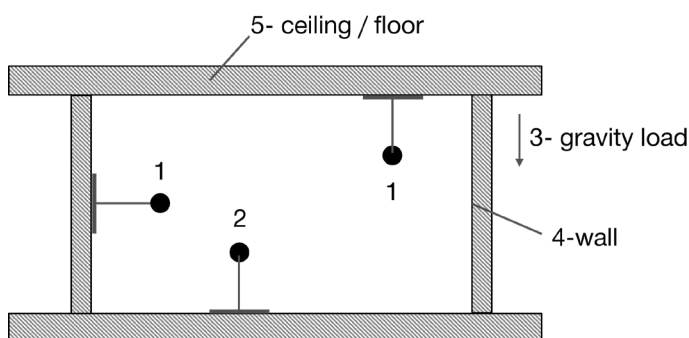

Fig. 6.35: Model showing vertical effect of seismic action

The horizontal effect of seismic can be calculated from the requirement mentioned in EC8-1 [40] with behavior factor  $q_a$ .

### 6.10.1.2 Horizontal seismic actions

The horizontal component of seismic action for type-B connections is considered if Section 4.3.5.1 (3) of EC8-1 [40] is satisfied. The horizontal effect is calculated as per the requirement given in EC8-1 [40] with behavior factor  $q_a$  as shown in Table 6.17.

Seismic effect is determined using a horizontal force  $F_a$  as mentioned in eq. (4.25) of EC8-1 [40] with the modification in seismic coefficient value,  $S_a$ .

$$S_a = \alpha \cdot S \cdot \left[ \left( 1 + \frac{z}{H} \right) \cdot A_a - 0.5 \right] \geq \alpha \cdot S \quad \text{EC2-4, eq. (C.3)}$$

$$A_a = \frac{3}{1 + \left( 1 - \frac{T_a}{T_1} \right)^2} \quad \text{EC2-4, eq. (C.4)}$$

$\alpha_g$  = design ground acceleration on type-A ground (see EC8-1 [40], sect. 3.2.1)

$S$  = soil factor (EC8-1 [40], sect. 3.2.2).

$T_a$  = fundamental period of vibration for type-B connections

$T_1$  = fundamental period of vibration of building at the relevant direction

$z$  = height of type-B element above level of application of seismic action

$H$  = building height measured from foundation or top of rigid basement

The value of  $A_a$  can be calculated from the above equation. If one of the fundamental periods of vibrations is unknown the values listed in Table 6.17 can be used.

The vertical effect of seismic action is calculated by applying a vertical force  $F_{va}$  as defined in following equation:

$$F_{va} = S_{va} \cdot W_a \cdot \gamma_a / q_a \quad \text{EC2-4, eq. (C.5)}$$

$$S_{va} = \alpha_v \cdot A_a \quad \text{EC2-4, eq. (C.6)}$$

**Note:** EC2-4 introduces the parameter  $A_a$  to simplify the calculations of EC8-1, since the fundamental period of vibration of the attached element is often not known.

**Table 6.17: Factors for non-structural elements according to EC2-4 [1]**

#	Type of non-structural element	$q_a$	$A_a$
1	Cantilevering parapets or ornamentations	1.0	3.0
2	Signs and billboards		3.0
3	Chimneys, masts and tanks on legs acting as unbraced cantilevers along more than one half of their total height		3.0
4	Hazardous material storage, hazardous fluid piping	2.0	3.0
5	Exterior and interior walls		1.5
6	Partitions and facades		1.5
7	Chimneys, masts and tanks on legs acting as unbraced cantilevers along less than one half of their total height, or braced or guyed to the structure at or above their center of mass		1.5
8	Elevators		1.5
9	Computer access floors, electrical and communication equipment		3.0
10	Conveyors		3.0
11	Anchorage elements for permanent cabinets and book stacks supported by the floor		1.5
12	Anchorage elements for false (suspended) ceilings and light fixtures		1.5
13	High pressure piping, fire suppression piping		3.0
14	Fluid piping for non-hazardous materials		3.0
15	Computer, communication and storage racks		3.0

### 6.10.2 Determination of seismic resistance of anchors

Table 6.18 includes the recommendation of EC2-4 [1] for the use of anchors assessed according to seismic category C1 and C2 as a function of the seismicity level and importance class of building/structure according to EC8-1 [40].

Table 6.18: Association of seismic categories with seismicity levels and importance classes of buildings/ structures as per EC8-1 [40].

Seismicity level			Importance Class acc. to EC8-1, sect. 4.2.5			
1	Class	$\alpha_g \cdot S^c$	I	II	III	IV
2	Very low	$\alpha_g \cdot S \leq 0.05g$	No seismic performance category required			
3	Low	$0.05g \leq \alpha_g \cdot S \leq 0.1g$	C1	C1 <sup>a</sup> or C2 <sup>b</sup>		C2
4	≥ low	$\alpha_g \cdot S > 0.1g$	C1	C2		

Note: Table 6.18 is modified in various ways in the National Annexes to EC2-4.

a= C1 for fixing Type-B connections; b = C2 for fixing Type-A connections

c:  $\alpha_g$  = ground acceleration on Type A ground; S = Soil factor

To resist seismic actions, different design strategies can be followed: 1) Capacity design 2) Elastic design and 3) ductile anchor design.

### 6.10.2.1 Capacity design

This refers to the approach which focuses on ensuring that structures are designed to be protected against brittle failure of fragile elements and/or connections during a seismic event. The idea is to create a **controlled and predictable failure mechanism** that helps prevent catastrophic failure. For the design of anchors according to ‘**capacity design**’, for both structural (type-A) and non-structural connections (type-B), the fastening is designed for the maximum load. The maximum load corresponds to either the development of a ductile yield mechanism in the attached steel component (Fig. 6.36 a) or in the steel baseplate (Fig. 6.36 b)), including strain hardening and material overstrength effects, or on the capacity of a non-yielding attached component or structural element (Fig. 6.36 c)).

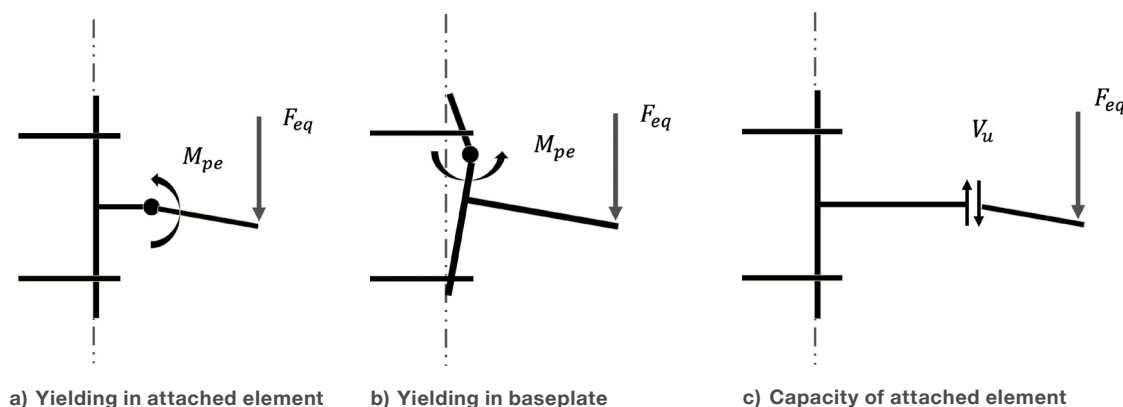

Fig. 6.36: Seismic design by protection of fastening

**Note:** This design approach is easy to follow. However, the anchors are subjected to the highest design actions. Special detailing of the attached element may be required to ensure the desired plastic mechanism.

### 6.10.2.2 Elastic design

This refers to the approach which focuses on designing structures to remain elastic during the seismic event. The goal is to ensure **structures that can withstand the seismic action without experiencing significant damage or collapse**. It involves analysis of structures using linear elastic behavior. For the design of anchors according to 'elastic design' the action effects for structural connections shall be derived according to EC8-1 [40] with a behavior factor  $q = 1.0$ . For non-structural connections the action effects shall be derived with behavior factor  $q_a = 1.0$ . If action effects are derived in accordance with the approach explained in [Section 6.10.1](#) with  $q_a = 1.0$ , they shall be multiplied by an amplification factor equal to 1.5. For a more precise derivation, this additional amplification may be ignored.

### 6.10.2.3 Design considering ductility of anchors

Seismic design requirements often include the ductility of anchors to enhance structures' ability to absorb energy during an earthquake. **Anchors help to prevent failures by allowing controlled deformation** that contributes to the overall seismic resilience of structures. The design of anchors according to '**design with requirements on the ductility of the fastener**', requires following conditions to be satisfied.

- The fastener requires an ETA including qualification for performance category C2.
- To ensure steel failure of the fastening, the following conditions must be satisfied.
  - 1) For steel failure of a single anchor:  $R_{ks,eq} \leq 0.7 \cdot (R_{k,conc,eq} / \gamma_{inst})$
  - 2) For steel failure of two or more anchors;  $(R_{ks,eq} / E_d^h) \leq 0.7 \cdot (R_{k,conc,eq} / E_d^h \cdot \gamma_{inst})$

$R_{ks,eq}$  = Characteristic resistance for steel failure,  $R_{k,conc,eq}$  = Characteristic resistance for all concrete related failures.

For a group of two or more anchors, the highest loaded fastener will be checked for pull-out failure as per point no. 1) mentioned above.

- Ductile fastener: ultimate tensile strength  $f_{uk} \leq 800 \text{ MPa}$  and yield to ultimate strength ratio,  $f_{yk} / f_{uk} \leq 0.8$ .

**Note:** This design approach requires the choice of anchors that, for the given boundary conditions (e.g., edge distances and spacings), fail due to steel rupture in tension.

The design resistance of anchors against seismic action are as follows:

$$R_{d,eq} = R_{k,eq} / \gamma_{m,eq} \quad \text{EC2-4, eq. (C.7)}$$

The characteristic seismic resistance  $R_{k,eq}$ :

$$R_{k,eq} = \alpha_{gap} \cdot \alpha_{eq} \cdot R_{k,eq}^0 \quad \text{EC2-4, eq. (C.8)}$$

- fastener and fixture in case of shear loading, given in the relevant ETA.
- $\alpha_{gap}$  is the reduction factor given in the ETA to consider the inertia effect due to clearance of the hole between anchor and fixture (i.e., hammering effect) under shear loading.
- $\alpha_{eq}$  is the factor to take into account the influence of seismic actions and associated cracking depending on:
  - a) Formation of large crack widths; and
  - b) Uneven tension stiffness of fasteners in a group due to random crack distribution

Refer to Table 6.19 for the values of  $\alpha_{eq}$ .

**Note:** An annular gap between fasteners and baseplate creates uneven shear distribution and significant ‘hammering effect’ under seismic action (see [58]). It is highly beneficial to limit these effects during dynamic loading with high amplitude load reversals, such as seismic. To make anchors suitable in such conditions for reversing shear loads, Hilti has developed a “filling set” (refer to [Section 5.1](#)). Shear resistance can be improved significantly as the factor,  $\alpha_{gap} = 1.0$  may be assumed in design.

**Note:** For more details regarding the Hilti filling set, see [Section 5.1.4](#)

Table 6.19: Reduction factor  $\alpha_{eq}$  according to EC2-4 [1]

Loading	Failure mode	Single fastener	Fastener group
Tension	Steel failure	1.0	1.0
	Concrete cone failure; Headed fastener and undercut fasteners with $k_1$ -factor same as headed fastener	1.0	0.85
	Concrete cone failure; all other fasteners	0.85	0.75
	Pull-out failure	1.0	0.85
	Combined pull-out and concrete failure (bonded fastener)	1.0	0.85
	Concrete splitting failure	1.0	0.85
	Concrete blow-out failure	1.0	0.85
Shear	Steel failure	1.0	0.85
	Concrete pry-out failure; Headed fastener and undercut fasteners with $k_1$ -factor same as headed fastener	1.0	0.85
	Concrete pry-out failure; all other fasteners	0.85	0.75
	Concrete edge failure	1.0	0.85

$R_{k,eq}^0$  is the basic characteristic seismic resistance for a given failure mode. For steel and pull-out Failure under tension and shear load  $R_{k,eq}^0$  shall be taken from the relevant ETA (i.e.,  $N_{RK,s,eq}$ ,  $N_{RK,p,eq}$ ,  $V_{RK,s,eq}$ ).

For combined pull-out and concrete failure in case of post-installed bonded fasteners  $R_{k,eq}^0$  shall be determined as for static and quasi static loading (refer to [Section 6.6.1](#)), however, using the characteristic bond resistance  $\tau_{Rk,eq}$  given in the relevant ETA.

For all other failure modes  $R_{k,eq}^0$  shall be determined as for static and quasi static loading (i.e., for tension load:  $N_{Rk,c}$ ,  $N_{Rk,sp}$ ,  $N_{Rk,cp}$ ,  $N_{Rk,re}$ ,  $N_{Rk,a} = \gamma_c \cdot N_{Rd,a}$ , and for shear load;  $V_{Rk,c}$ ,  $V_{Rk,cp}$ ,  $V_{Rk,a} = \gamma_c \cdot V_{Rd,a}$  .

Partial safety factors for the calculation of resistance against seismic loading may be taken from static design ([Section 6.6](#)).

Check for combination of tension and shear load:

$$\left(\frac{N_{Ed}}{N_{Rd,eq}}\right)^{k_{15}} + \left(\frac{V_{Ed}}{V_{Rd,eq}}\right)^{k_{15}} \leq 1 \quad \text{EC2-4, eq. (C.9)}$$

- $N_{Ed}$  and  $V_{Ed}$  are the design seismic actions on the fasteners for the corresponding failure modes.
- $k_{15} = 1$  for steel failure,  $2/3$  for fastenings with a supplementary reinforcement against tension or shear loads only, and  $1$  in all other cases.

### 6.10.2.4 Displacement of fasteners for seismic action

The displacement at **damage limit state (DLS)** and **ultimate limit state (ULS)** are defined in the ETA for each embedment depth and diameter of an anchor against both tension and shear loading ( $\delta_{N,C2,DLS}$ ,  $\delta_{V,C2,DLS}$ ,  $\delta_{N,C2,ULS}$  and  $\delta_{V,C2,ULS}$ ). The anchor displacement should be limited to  $\delta_{N,req,DLS} \leq \delta_{N,C2,DLS}$  under tensile load and to  $\delta_{V,req,DLS} \leq \delta_{V,C2,DLS}$  under shear loads at DLS. This is required to meet functional and support requirements, depending on the application. Anchors should also be able to accommodate expected rotations. The rotation of the connection  $\theta_p$  can be taken as equal to  $\delta_{N,eq} / s_{max}$ , where  $\delta_{N,eq}$  is the displacement of the anchor under seismic load and  $s_{max}$  is the distance between the outermost row of the anchors and the opposite edge of the fixture. [EC2-4 [1], eq. (C.10)].

**Note:** The Hilti filling set allows a reduction of the shear displacements at DLS and ULS.

If a rigid support is assumed in design, then it shall be established that the limiting displacement is compatible to the structural behavior/requirement. The designer may require a displacement/rotation smaller than the values published in an ETA at DLS.

EC2-4 [1] allows to linearly reduce the loads to account for maximum displacements in a specific application as follows:

$$N_{Rd,eq,red} = N_{Rd,eq} \cdot \frac{\delta_{N,req,DLS}}{\delta_{N,eq,DLS}} \quad \text{EC2-4, eq. C.11 a)}$$

$$V_{Rd,eq,red} = V_{Rd,eq} \cdot \frac{\delta_{V,req,DLS}}{\delta_{V,eq,DLS}} \quad \text{EC2-4, eq. C.11 b)}$$

### 6.10.3 Design example of post-installed anchors against seismic loading

Project requirement: A square hollow section is attached to concrete slab with a steel baseplate. The connection is established using chemical anchors ( Fig. 6.37).

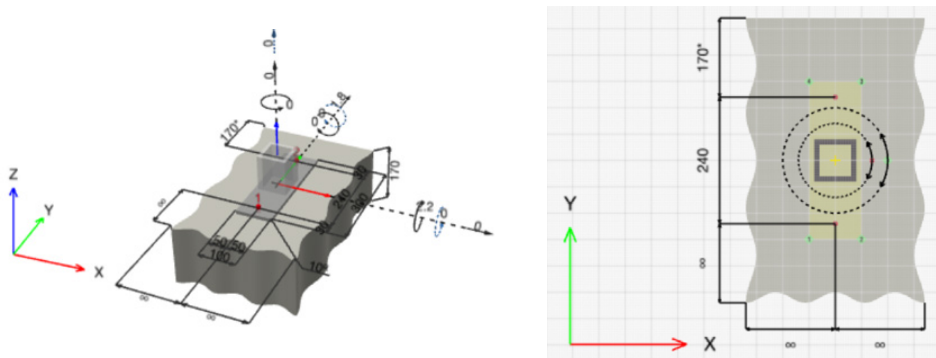

Fig. 6.37: Baseplate connection using post-installed chemical anchors

Relevant project information:

Geometry of concrete:	Slab thickness, $h = 170 \text{ mm}$
Geometry of baseplate:	Plate dimension, $l \times w = 300 \times 100 \text{ mm}$
	Plate thickness, $t = 20 \text{ mm}$
Materials:	Normal weight concrete C25/30, cracked
	Surface reinforcement with spacing of $200 \text{ mm}$
Loading:	Bending moment, $M_{Ed} = 2.2 \text{ kNm}$



	Shear, $V_{Ed} = 1.8 \text{ kN}$ (no stand-off)
Limiting Displacement	$\delta_{N,req(DLS)} = 1 \text{ mm}$ in tension and $\delta_{V,req(DLS)} = 5 \text{ mm}$ in shear
Steel profile:	Square hollow section of $80 \times 80 \times 10 \text{ mm}$
Design working life:	50 years
Seismic performance category:	C2
Seismic proof type:	Elastic design

Details of post-installed anchors:

Type of anchor:	Chemical
No of anchors:	2
Spacing between anchors in Y	240 mm
Edge distance along Y	170 mm

Installation condition of post-installed anchors:

Drilling method/orientation:	Rotary-hammer drilling/horizontal, dry
Installation/in-service temp.:	24°C (long term)/40°C (short term)
Design working life:	50 years
System/solution choice:	Hilti HIT-HY 200-A V3 bonded anchor with anchor rod HAS-U 8.8 (ETA-19/0601 [41]) without the Hilti Filling Set.

1) Analysis of tension and shear forces:

Moment acting on anchor group,  $M_{Ed,eq} = 2.2 \text{ kNm}$  will be divided in tension and compression among all anchors. For this, the neutral axis is calculated and the force on each anchor is analyzed and shown in Fig. 6.38. Total tension force on anchor group,  $N_{Ed,eq} = 8.9 \text{ kN}$ . Total shear force acting on anchor group is  $V_{Ed,eq} = 1.8 \text{ kN}$ . It is equally distributed among the two anchors for steel and pry-out verification. It is entirely taken by the front anchor for the concrete edge break-out check.

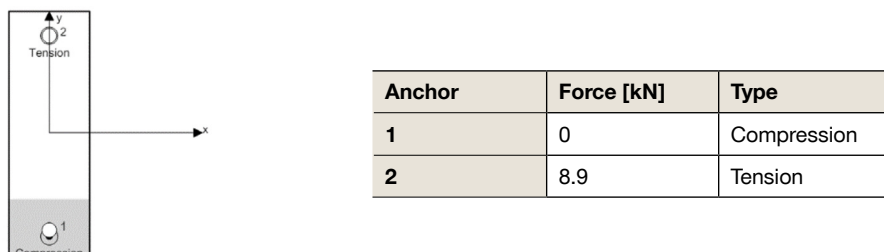

Fig. 6.38: Force analysis of anchors

2) Details of proposed anchor: The proposed anchor solution is described in Table 6.20.

Table 6.20: Anchor properties for seismic

Type of anchor	Chemical	
Specification of anchor	HIT-HY 200-A V3 + HAS U 8.8	
Diameter of anchor	$d$	16 mm
Effective embedment depth	$h_{ef}$	100 mm

Design verifications are carried considering rigid baseplate as per EC2-4 [1] and characteristic resistances are taken from ETA-19/0601 [41]. For details on the calculations of resistances against the different failure modes please refer to [Section 6.10](#).

### Check of tension load failures:

#### Steel failure:

The resistance against steel failure is calculated for the most stressed anchor using following equation:

$$N_{Rd,s,eq} = \frac{N_{Rk,s,eq}}{\gamma_{M,s,eq}} \quad \text{EC2-4, eq. (C.7) Annex C, sect. C.5}$$

$$N_{Rk,s,eq}^0 = A_s \cdot f_{uk} = 157 \cdot 800 = 125.6 \text{ kN} \quad \text{ETA-19/0601, Table C23}$$

$$N_{Rk,s,eq} = \alpha_{eq} \cdot N_{Rk,s,eq}^0 = 1.0 \cdot 125.6 = 125.6 \text{ kN} \quad \text{EC2-4, eq. (C.8) and Table C.3}$$

$$\gamma_{M,s,eq} = 1.5 \quad \text{ETA-19/0601, Table C1}$$

$$N_{Rd,s,eq} = \left( \frac{125.6}{1.5} \right) = 83.7 \text{ kN} > N_{Ed,eq}^h = 8.9 \text{ kN} \quad \text{verification fulfilled} \checkmark$$

#### Concrete cone failure:

The resistance against concrete cone failure is checked for the entire anchor group with the following equation:

$$N_{Rd,c,eq} = \frac{N_{Rk,c,eq}}{\gamma_{M,c,eq}} \quad \text{EC2-4, Table 7.1, Annex-C, sect. C.5}$$

$$N_{Rk,c,eq}^0 = k_1 \cdot \sqrt{f_{ck}} \cdot h_{ef}^{1.5} = 7.7 \cdot \sqrt{25} \cdot 100^{1.5} = 38.5 \text{ kN} \quad \text{EC2-4, eq. (7.2)}$$

$$s_{cr,N} = 2 \cdot c_{cr,N} = 3 \cdot h_{ef} = (3 \cdot 100) = 300 \text{ mm}, c_{cr,N} = 150 \text{ mm} \quad \text{EC2-4, sect. 7.2.1.4 (3)}$$

$$A_{c,N} = (150 + 150) \cdot (150 + 150) = 90,000 \text{ mm}^2 \quad \text{EC2-4, Fig. 7.4}$$

$$A_{c,N}^0 = s_{cr,N} \cdot s_{cr,N} = (300 \cdot 300) = 90,000 \text{ mm}^2 \quad \text{EC2-4, eq. (7.3)}$$

$$\psi_{s,N} = 0.7 + 0.3 \cdot \frac{c}{c_{cr,N}} = 1 \quad \text{EC2-4, eq. (7.4)}$$

$$\psi_{re,N} = 0.5 + \frac{h_{ef}}{200} \leq 1.0 \quad \text{EC2-4, eq. (7.5)}$$

$$\psi_{re,N} = 1.0, \text{ Surface reinforcement with spacing of } 200 \text{ mm}$$

$$\psi_{ec,N} = \frac{1}{1 + \left( \frac{2 \cdot e_{c,N}}{s_{cr,N}} \right)} \quad \text{EC2-4, eq. (7.6)}$$

$$\text{Eccentricity along X axis } e_{c,N} = 0 \text{ mm, hence } \psi_{ec,N} = 1.0$$

$$\text{Eccentricity along Y axis } e_{c,N} = 0 \text{ mm, hence } \psi_{ec,N} = 1.0$$

$$\text{Factor for bending moment, } \psi_{M,N} = 1.0 \quad \text{EC2-4, eq. (7.7)}$$

$$\text{Reduction factor, } \alpha_{eq} = 0.85 \text{ for single anchor} \quad \text{EC2-4, Table C3}$$

$$N_{Rk,c,eq} = \alpha_{eq} \cdot N_{Rk,c,eq}^0 \cdot \frac{A_{c,N}}{A_{c,N}^0} \cdot \psi_{s,N} \cdot \psi_{re,N} \cdot \psi_{ec,N} \cdot \psi_{M,N}$$

$$N_{Rk,c,eq} = 0.85 \cdot 38.5 \cdot \left( \frac{90,000}{90,000} \right) \cdot 1.0 \cdot 1.0 \cdot 1.0 \cdot 1.0 = 32.7 \text{ kN}, \gamma_{M,c} = 1.5$$

$$N_{Rd,c,eq} = \left( \frac{32.7}{1.5} \right) = 21.8 \text{ kN} > N_{Ed,eq} = 8.9 \text{ kN} \quad \text{verification fulfilled} \checkmark$$

#### Combined concrete cone and pull-out failure:

The resistance of combined cone and pull-out is checked by following expression from EC2-4 [1]:

$$N_{Rd,p,eq} = \frac{N_{Rk,p,eq}}{\gamma_{M,p,eq}} \quad \text{EC2-4, Table 7.1, Annex-C, sect. C.5}$$

The characteristic resistance for this failure mode is:

$$N_{Rk,p,eq} = \alpha_{eq} \cdot N_{Rk,p}^0 \cdot \frac{A_{p,N}}{A_{p,N}^0} \cdot \psi_{g,Np} \cdot \psi_{s,Np} \cdot \psi_{re,N} \cdot \psi_{ec,Np} \quad \text{EC2-4, eq. (7.13)}$$

$$\tau_{Rk,eq} = 4.6 \text{ MPa} \quad \text{ETA-19/0601, Table C23}$$

$$\tau_{Rk,ucr} = 18 \text{ MPa for C20/25} \quad \text{ETA-19/0601, Table C1}$$

$$\tau_{Rk,cr} = 9.5 \text{ MPa for C20/25} \quad \text{ETA-19/0601, Table C1}$$

$$\psi_{sus} = 1.0 \text{ as } \psi_{sus}^0 = 0.8 \text{ and } \alpha_{sus} = 0 \quad \text{EC2-4, eq. (7.14a), ETA-19/0601, Table C1}$$

$$s_{cr,Np} = 7.3 \cdot d \cdot (\psi_{sus} \cdot \tau_{Rk})^{0.5} = 7.3 \cdot 16 \cdot (1.0 \cdot 18)^{0.5} = 496 \geq 3 \cdot 100$$

$$s_{cr,Np} = 300 \text{ mm} \quad \text{EC2-4, eq. (7.15)}$$

$$c_{cr,Np} = s_{cr,Np} / 2 = (300/2) = 150 \text{ mm}$$

$$k_3 = 7.7 \text{ for cracked concrete} \quad \text{ETA-19/0601, Table C1}$$

$$\tau_{Rkc} = \frac{k_3}{\pi \cdot d} \cdot \sqrt{(h_{ef} \cdot f_{ck})} = \frac{7.7}{\pi \cdot 16} \cdot \sqrt{(100 \cdot 25)} = 7.66 \text{ MPa} \quad \text{EC2-4, eq. (7.19)}$$

$$\psi_{g,Np}^0 = \sqrt{n} - \sqrt{(n-1)} \cdot \left( \frac{\tau_{Rk,eq}}{\tau_{Rkcr}} \right)^{1.5} = \sqrt{1} - \sqrt{(1-1)} \cdot \left( \frac{4.6}{18} \right)^{1.5} \geq 1, \psi_{g,Np}^0 = 1.0 \quad \text{EC2-4, eq. (7.18)}$$

$$\psi_{g,Np} = \psi_{g,Np}^0 - \left( \frac{s}{s_{cr,Np}} \right)^{0.5} \cdot (\psi_{g,Np}^0 - 1) = 1 - \left( \frac{240}{371.7} \right)^{0.5} \cdot (1 - 1) \geq 1, \psi_{g,Np} = 1.0 \quad \text{EC2-4, eq. (7.17)}$$

$$e_{c,N} = 0, \psi_{ec,Np} = \left( \frac{1}{1 + 2 \cdot \frac{e_{c,N}}{s_{cr,Np}}} \right) = \left( \frac{1}{1 + 2 \cdot \frac{0}{453}} \right) = 1.0 \quad \text{EC2-4, eq. (7.21)}$$

$$\psi_{s,Np} = 0.7 + 0.3 \cdot \left( \frac{c}{c_{cr,Np}} \right) = 1.0 \quad \text{EC2-4, eq. (7.20)}$$

$$\psi_{re,N} = 1.0$$

$$A_{p,N}^0 = s_{cr,Np} \cdot s_{cr,Np} = 300 \cdot 300 = 90,000 \text{ mm}^2$$

$$A_{p,N} = A_{p,N}^0 = 90,000 \text{ mm}^2$$

$$N_{Rk,p}^0 = \psi_{sus} \cdot \tau_{Rk,eq} \cdot \pi \cdot d \cdot h_{ef} = 1 \cdot 4.6 \cdot \pi \cdot 16 \cdot 100 = 23.1 \text{ kN} \quad \text{EC2-4, eq. (7.14)}$$

$$\text{Reduction factor, } \alpha_{eq} = 1.0 \text{ for single anchor} \quad \text{EC2-4, Table C.3}$$

$$N_{Rk,p,eq} = \alpha_{eq} \cdot N_{Rk,p}^0 \cdot \frac{A_{p,N}}{A_{p,N}^0} \cdot \psi_{g,Np} \cdot \psi_{s,Np} \cdot \psi_{re,N} \cdot \psi_{ec,Np}$$

$$N_{Rk,p,eq} = 1.0 \cdot 23.1 \cdot \frac{90,000}{90,000} \cdot 1.0 \cdot 1.0 \cdot 1.0 \cdot 1.0 = 23.1 \text{ kN}$$

$$N_{Rd,p,eq} = \left( \frac{23.1}{1.5} \right) = 15.4 \text{ kN} > N_{Ed,eq} = 8.9 \text{ kN} \quad \text{verification fulfilled} \checkmark$$

### Concrete splitting failure:

With reference to the criteria given in EC2-4 [1], sect. 7.2.1.7 (2) b) 2), the splitting failure is resisted by reinforcement in concrete with limitation in crack width of  $w_k \leq 0.3 \text{ mm}$ .

### Check of shear load failures:

#### Steel failure:

The resistance against steel failure is calculated for the most stressed anchor using following equation:

$$V_{Rd,s,eq} = \frac{V_{Rk,s,eq}}{\gamma_{Ms,eq}} \quad \text{EC2-4, Table 7.2 Annex C, sect. C.5}$$

$$\gamma_{Ms,eq} = 1.25 \quad \text{ETA-19/0601, Table C2}$$

$$\alpha_{gap} = 0.5 \text{ and } \alpha_{eq} = 0.85 \quad \text{EC2-4, sect. C.5 and Table C.3}$$

$$V_{Rk,s,eq}^0 = 40 \text{ kN} \quad \text{ETA-19/0601, Table C24}$$

$$V_{Rk,s,eq} = \alpha_{gap} \cdot \alpha_{eq} \cdot k_7 \cdot V_{Rk,s,eq}^0 = 0.5 \cdot 0.85 \cdot 1.0 \cdot 1.0 \cdot 40 = 17 \text{ kN}$$

$$V_{Rd,s,eq} = \left( \frac{17}{1.25} \right) = 13.6 \text{ kN} > V_{sd1,eq} = 0.9 \text{ kN} \quad \text{verification fulfilled} \checkmark$$

### Concrete pry-out failure:

The resistance against concrete pry-out failure is calculated for the group of anchors:

$$V_{Rd,cp,eq} = \frac{V_{Rk,cp,eq}}{\gamma_{Mcp,eq}} \quad \text{EC2-4, Table 7.2 Annex C, sect. C.5}$$

$$\gamma_{Mcp,eq} = 1.5$$

$$k_8 = 2 \quad \text{ETA-19/0601, Table C2}$$

$$\alpha_{gap} = 0.5 \text{ and } \alpha_{eq} = 0.75 \quad \text{EC2-4, sect. C.5 and Table C.3}$$

The characteristic resistance of a single anchor is taken from the check of concrete cone failure:

$$N_{Rk,c}^0 = 38.5 \text{ kN}, \psi_{s,N} = 1.0, \psi_{re,N} = 1.0 \text{ [ same as concrete cone failure]}, \psi_{ec,N} = 1.0$$

$$A_{c,N} = (150 + 240 + 150) \cdot (150 + 150) = 162,000 \text{ mm}^2 \quad \text{EC2-4, Fig. 7.4}$$

$$A_{c,N}^0 = s_{cr,N} \cdot s_{cr,N} = (300 \cdot 300) = 90,000 \text{ mm}^2 \quad \text{EC2-4, eq. (7.3)}$$

$$N_{Rk,c} = N_{Rk,c}^0 \cdot \frac{A_{c,N}}{A_{c,N}^0} \cdot \psi_{s,N} \cdot \psi_{re,N} \cdot \psi_{ec,N} = 38.5 \cdot \frac{162,000}{90,000} \cdot 1.0 \cdot 1.0 \cdot 1.0 = 38.5 \text{ kN},$$

$$V_{Rk,cp} = 69.3 \cdot 2 = 138.6 \text{ kN}$$

$$V_{Rk,cp,eq} = \alpha_{gap} \cdot \alpha_{eq} \cdot k_8 \cdot N_{Rk,c} = 0.5 \cdot 0.75 \cdot 138.6 = 52 \text{ kN} \quad \text{EC2-4, Annex C, sect. C.5}$$

$$V_{Rd,cp,eq} = \left( \frac{52}{1.5} \right) = 34.7 \text{ kN} > V_{Ed,eq} = 1.8 \text{ kN} \quad \text{verification fulfilled } \checkmark$$

### Concrete edge failure: Shear acting perpendicular to edge $Y^+$

The resistance against concrete edge is checked for the shear force perpendicular to bottom edge in the direction of  $Y^+$ , the force is acting on front anchors.

$$V_{Rd,c,eq} = \frac{V_{Rk,c,eq}}{\gamma_{Mc,eq}} \quad \text{EC2-4, Table 7.2}$$

$$\gamma_{Mc} = 1.5$$

$$l_f = h_{ef} = 100 \text{ mm}, c_1 = 170 \text{ mm}, k_v = 1.7 \text{ for cracked concrete}$$

$$\alpha = 0.1 \cdot \left( \frac{l_f}{c_1} \right)^{0.5} = 0.1 \cdot \left( \frac{100}{170} \right)^{0.5} = 0.077 \quad \text{EC2-4, eq. (7.42)}$$

$$\beta = 0.1 \cdot \left( \frac{d_{nom}}{c_1} \right)^{0.2} = 0.1 \cdot \left( \frac{16}{170} \right)^{0.2} = 0.062 \quad \text{EC2-4, eq. (7.43)}$$

$$V_{Rk,c}^0 = k_v \cdot d_{nom}^\alpha \cdot l_f^\beta \cdot \sqrt{f_{ck}} \cdot c_1^{1.5} = 1.7 \cdot 16^{0.077} \cdot 100^{0.062} \cdot \sqrt{25} \cdot 170^{1.5} = 31.1 \text{ kN} \quad \text{EC2-4, eq. (7.41)}$$

$$A_{c,V}^0 = 4.5 c_1^2 = 4.5 \cdot 170^2 = 130,050 \text{ mm}^2 \quad \text{EC2-4, eq. (7.44)}$$

$$A_{c,V} = 86,700 \text{ mm}^2$$

$$\psi_{s,V} = 0.7 + 0.3 \cdot \left( \frac{c_2}{1.5c_1} \right) \leq 1.0, \psi_{s,V} = 1.0$$

$$\psi_{h,v} = 1.225, \psi_{ec,v} = 1.0, \psi_{a,v} = 1.0$$

$$\alpha_{gap} = 0.5 \text{ and } \alpha_{eq} = 0.85 \quad \text{EC2-4, sect. C.5 and Table C.3}$$

$$V_{Rk,c,eq} = \alpha_{gap} \cdot \alpha_{eq} \cdot V_{Rk,c}^0 \cdot \frac{A_{c,V}}{A_{c,V}^0} \cdot \psi_{a,v} \cdot \psi_{h,v} \cdot \psi_{s,V} \cdot \psi_{ec,v} \cdot \psi_{re,v}$$

$$V_{Rk,c,eq} = 0.5 \cdot 0.85 \cdot 31.1 \cdot \frac{86,700}{130,050} \cdot 1.0 \cdot 1.225 \cdot 1.0 \cdot 1.0 \cdot 1.0 = 10.8 \text{ kN}$$

$$V_{Rd,c,eq} = \left( \frac{10.8}{1.5} \right) = 7.2 \text{ kN} > V_{Ed,eq} = 1.8 \text{ kN} \quad \text{verification fulfilled } \checkmark$$

### Check for combined tension and shear load:

Steel failure: EC2-4, Table 7.3, Annex C, sect. C.5

$$\text{Ratio between action load and resistance in tension, } \beta_N = \left( \frac{8.9}{83.7} \right) = 0.11 \leq 1.0$$

Ratio between action load and resistance in shear,  $\beta_v = \left(\frac{0.9}{13.6}\right) = 0.07 \leq 1.0$

$$\beta_N^{k_{15}} + \beta_v^{k_{15}} = 0.11^{1.0} + 0.07^{1.0} = 0.18 \leq 1.0$$

verification fulfilled ✓

Failure other than steel:

EC2-4, Table 7.3 Annex C, sect. C.5

Ratio between action load and resistance in tension,  $\beta_N = \left(\frac{8.9}{15.4}\right) = 0.58 \leq 1.0$

Ratio between action load and resistance in shear,  $\beta_v = \left(\frac{1.8}{7.2}\right) = 0.25 \leq 1.0$

$$\beta_N^{k_{15}} + \beta_v^{k_{15}} = 0.58^{1.0} + 0.25^{1.0} = 0.83 \leq 1.0$$

verification fulfilled ✓

**Note:** Using Hilti filling set the utilization ratio for steel failure is 14% and for failure other than steel is 71%.

Now, the design is checked with some other post-installed combined anchor solution with the same boundary conditions (refer to Table 6.21).

Table 6.21: Anchor properties for seismic (combined system)

Type of anchor	Combined mechanical and bonded	
Specification of anchor	HUS4-MAX	
Diameter of anchor	<i>d</i>	12 mm
Effective embedment depth	<i>h<sub>ef</sub></i>	100 mm



The summary of utilization ratio against different failure modes under tension and shear loading is shown in Table 6.22. For comparison also a solution with HIT-HY 200 A-V3 M12 and maximum allowed  $h_{ef} = 140 \text{ mm}$  for the given member thickness of 170 mm is shown in the Table 6.22. As you can see, this solution leads to a utilization significantly higher than 100% and therefore, it is not acceptable.

Table 6.22: Utilization against failure modes

Load direction	Failure modes	Utilization [%] – HUS4 MAX d12, <i>h<sub>ef</sub></i> = 100 mm	Utilization [%] – HIT- HY 200 A-V3 M16, <i>h<sub>ef</sub></i> = 100 mm	Utilization [%] – HIT- HY 200 A-V3 M12, <i>h<sub>ef</sub></i> = 140 mm
Tension	Steel	17	11	20
	Concrete cone	41	41	25
	Combined pull-out and concrete cone	71	58	92
Shear	Steel	11	7	12
	Concrete pry-out	11	6	5
	Concrete edge	27	25	25
Combination	Steel	28	18	31
	Failure other than steel	98	83	117

The displacement values are also checked for seismic C2 design and presented in Table 6.23.

Table 6.23: Displacements  $\delta_{N,eq(DLS)}$  and  $\delta_{V,eq(DLS)}$

Loading	Displacement [mm]	HUS4 MAX d12, $h_{ef} = 100 \text{ mm}$	HIT- HY 200 A-V3 M16, $h_{ef} = 100 \text{ mm}$
Tension	$\delta_{N,eq(DLS)}$	0.7 mm	0.4 mm
Shear	$\delta_{V,eq(DLS)}$	4.9 mm	3.2 mm

The displacements values are within the project requirement and hence, no reduction is required for the resistance values against failure modes for tension and shear loading. However, if the requirement of limiting displacement is lesser than the design value, the resistance values must be reduced by the ratio between the required and design displacement values as explained in [Section 6.10.2.4](#). Accordingly, the utilization ratios will also increase due to reduction in resistance values considering the effect of limiting displacements.

**Note:** It is observed that for the same loading, the utilization of resistance is within the allowable range against the design seismic action for both HIT-HY 200-A V3 M16 and HUS4-MAX d12 anchor systems. However, the size of anchor required for HUS4-MAX hybrid system is smaller than HIT-HY 200 for the same embedment depth. Also, HIT-HY 200-A V3 bonded anchor requires curing time as mentioned in [Chapter 5](#) to achieve the desired performance. It implies that the HUS4-MAX anchor system helps to reach a more optimized solution with easier installation.

## 6.11 Design under fire exposure as per EC2-4 and EOTA TR 082

According to the principles of EC2-1-2 [42], the verification format Load vs. resistance follows, under fire exposure, the same principle as for static loading, but with reduced safety factors (Table 6.24). The difference between considerations in fire and static design is shown in Fig. 6.39.

**Ultimate limit state design concept:**

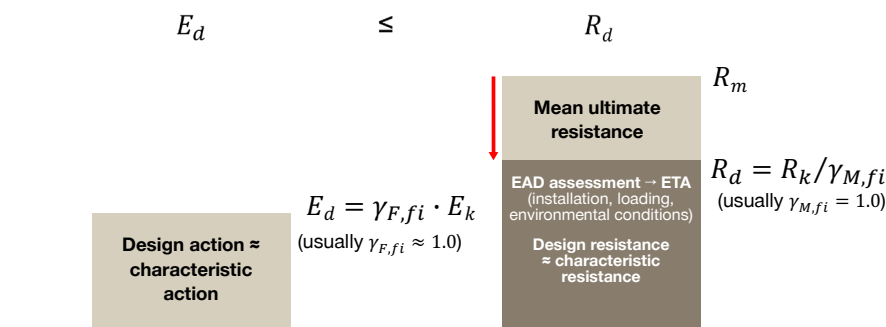
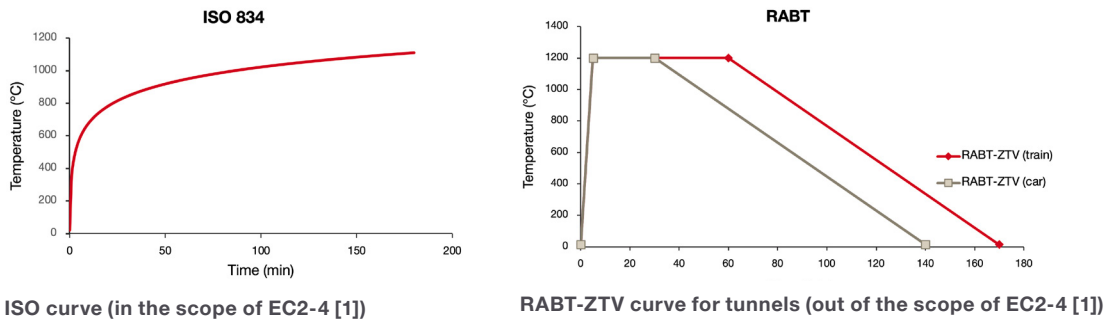

Fig. 6.39: Load vs resistance concept in fire design

Fire resistance of anchors is assessed considering temperature-time profiles classified according to EN 13501-2 [43] using the Standard ISO 834-1 [13] time-temperature curve (STC), which is the same used by EC2-1-2 [42]. For special applications, e.g., rail/car tunnels, different fire curves may be followed, e.g., RABT for road tunnels (RABT-ZTV-ING (Car) [44]) and ZTV/EBA for rail tunnels (RABT-ZTV-ING (Train) [44], [45]), see Fig. 6.40.



**Note:** Different fire curves affect the performance of post-installed anchors. For more information, please contact Hilti.

Fig. 6.40: Fire curves considered in design

The design method is defined in EC2-4 [1], Annex D against the relevant failure modes for post-installed anchors. However, the design check against combined pull-out and concrete cone failure is not covered. Hence, EC2-4 [1] is only restricted to mechanical anchors ([Section 6.11.1](#)). For the design of bonded anchors, EOTA published the TR 082 [46] where the design for combined failure check is described. The design scope of EC2-4 [1] and EOTA TR 082 [46] is further discussed in next [Sections 6.11.1](#) and [6.11.2](#).

**Note:** EC2-4, Annex D does not include provisions to design of bonded anchors under fire exposure.

### 6.11.1 Design against fire condition as per EC2-4

Fire design of fasteners is dependent on two primary criteria: **fire resistance** and **fire exposure**. In general, **cracked concrete** must be assumed for fire design. Concrete splitting failure is not calculated, hence sufficient reinforcement must be present in concrete to take care of this failure. Fire exposure can cause spalling of concrete which shall also be taken into account by a suitable factor for reinforcement in concrete.

The design method in EC2-4 [1] covers post-installed mechanical anchors for **one sided fire exposure of up to 120 minutes**. Also, if there is requirement for the design of anchors for more than one side of fire exposure, **edge distance of the second side must be greater than or equal to 300 mm and  $2h_{ef}$** . Considering these large edge distance criteria, we can assume that the fire will not have any effect on the far most exposed side.

Anchors under fire exposure must have an **ETA for use in cracked concrete and characteristic resistances under fire exposure**. The design of anchors under fire exposure is carried out according to the design method for the ambient temperature mentioned in EC2-4 [1] for static loading (refer to [Section 6.6](#)). However, partial factors and characteristic resistances under fire exposure are used instead of the corresponding values under ambient temperature in line with the requirements of EC2-1-2 [42]. Referring to the Table 6.4 and Table 6.8 for resistance against static loading, fire design resistances are derived using relevant partial safety factors for fire, as defined in Table 6.24.

Table 6.24: Partial safety factors for fire design as per EC2-4 [1]

Failure mode		Partial safety factor	Reference value
Tension	Steel	$\gamma_{M,s,fi}$	1.0
	Concrete cone break-out	$\gamma_{M,c,fi}$	$1.0 \cdot \gamma_{inst}$ ( $\gamma_{inst}$ is taken from ETA)
	Pull-out	$\gamma_{M,p,fi}$	$1.0 \cdot \gamma_{inst}$
	Combined concrete cone and pull-out	$\gamma_{M,p,fi}$	$1.0 \cdot \gamma_{inst}$
Shear	Steel	$\gamma_{M,s,fi}$	1.0
	Concrete pry-out	$\gamma_{M,cp,fi}$	$1.0 \cdot \gamma_{inst}$
	Concrete edge break-out	$\gamma_{M,c,fi}$	$1.0 \cdot \gamma_{inst}$

### 6.11.1.1 Design check for tension loading

#### Resistance against steel failure

The design resistance against steel failure is defined in EC2-4 [1] Annex D, sect. D.4.2 where the characteristic resistance,  $N_{Rk,s,fi}$  is taken from relevant ETA.

**Note:** It has been observed that the performance of anchors made of stainless steel is better than carbon steel with respect to tensile strength, even for indoor applications. Using stainless steel anchors, design can be optimized.

#### Resistance against pull-out failure

The pull-out resistance follows same equation as for steel failure and static resistance, except the partial safety factor is considered for fire from the relevant ETA and EC2-4 [1] as per Table 6.24.

The characteristic resistance,  $N_{Rk,p,fi}$  is defined from the resistance formula applicable for static loading with a reduction factor as defined below:

$$N_{Rk,p,fi} = 0.25 \cdot N_{Rk,p} \quad (\text{fire exposure} < 90 \text{ mins}) \text{ EC2-4, Annex D, eq. (D.4)}$$

$$N_{Rk,p,fi} = 0.20 \cdot N_{Rk,p} \quad (\text{fire exposure between 90 and 120 mins}) \text{ EC2-4, Annex D, eq. (D.5)}$$

$N_{Rk,p}$  is the resistance value derived for static loading in C20/25. Refer to [Section 6.6.1](#).

#### Concrete cone failure

The resistance for concrete cone failure is calculated with reference to the equation for the resistance against static loading (refer to [Section 6.6.1](#)). A reduction factor is considered over the static characteristic resistance for single anchor which is not influenced by adjacent fastener or edges of concrete,  $N_{Rk,c}^0$  according to EC2-4 [1]:

**Note:** Positive influence of concrete strength greater than C20/25 cannot be used under fire exposure for concrete related failure modes.



$$N_{Rk,c,fi}^0 = \frac{h_{ef}}{200} \cdot N_{Rk,c}^0 \leq N_{Rk,c}^0 \quad (\text{fire exposure} < 90 \text{ mins}) \text{ EC2-4 Annex-D, eq. (D.2)}$$

$$N_{Rk,c,fi}^0 = 0.8 \cdot \frac{h_{ef}}{200} \cdot N_{Rk,c}^0 \leq N_{Rk,c}^0 \quad (\text{fire exposure between 90 and 120 mins}) \text{ EC2-4 Annex-D, eq. (D.3)}$$

The fire resistance is considerably reduced for small embedment depths. For an embedment depth of 200 mm or more, the basic concrete break-out fire characteristic resistance is same as for the static loading. The pattern of change in resistance value for a single anchor for varying embedment depth against fire exposure of up to 90 mins is shown in graph of Fig. 6.41.

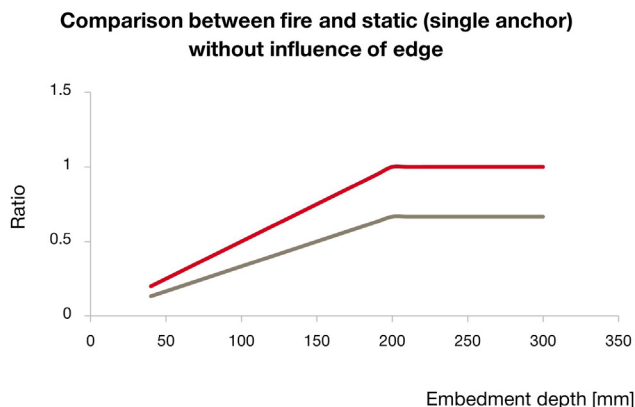

Fig. 6.41: Reduction factor for resistance against concrete cone failure

Characteristic resistance,  $N_{Rk,c,fi}$  is calculated following same equation as for static loading only by replacing  $N_{Rk,c}$  with  $N_{Rk,c,fi}$  and other partial factors,  $\psi_{s,N,fi}$ ,  $\psi_{ec,N,fi}$ ,  $\psi_{M,N,fi}$ ,  $\psi_{re,c,fi}$  etc. are considered for fire exposure. Actual and reference projected area,  $A_{c,N}^0$  and  $A_{c,N}$  are considered from anchor geometry and spacing, edge distance applicable for fire design.

**Note:** For design against fire loading, critical edge distance and spacing are higher than the value for cold design.  $s_{cr,N} = 2 \cdot c_{cr,N} = 4h_{ef}$ ,  $c_{cr,N} = s_{cr,N}/2$

### 6.11.1.2 Design checks for shear load

#### Resistance against steel failure

##### Shear without lever arm

The resistance against steel failure, where shear force is applied without a lever arm, follows the same principle as for static loading. The characteristic resistance,  $V_{Rk,s,fi}$  is taken from the relevant ETA and design resistance is calculated as per EC2-4 [1] sect. 7.2.2, and Annex D, sect. D.4.3.1.

Also under shear loading, anchors made of stainless steel perform better than carbon steel.

##### Shear with lever arm

The characteristic shear resistance with a lever arm is derived from the equation available for static loading (refer to [Section 6.6.1](#)). However, the characteristic bending resistance,  $M_{Rk,s,fi}$  according to EC2-4 [1], Annex D (D.4.3.1) eq. (D.7) is as below.

$M_{Rk,s,fi} = 1.2 \cdot W_{el} \cdot \sigma_{Rk,s,fi}$ ,  $W_{el}$  is the elastic section modulus calculated for a stressed cross section.

$\sigma_{Rk,s,fi}$  = characteristic steel tensile/shear strength under fire calculated according to EC2-4 [1], sect. D.4.2.1.

### Resistance against concrete pry-out failure

The resistance against pry-out failure is calculated as follows.

$$V_{Rk,c,fi(90)} = k_8 \cdot N_{Rk,c,fi(90)} \quad (\text{fire exposure } <90 \text{ mins}) \text{ EC2-4, Annex D, sect. D.4.3.2}$$

$$V_{Rk,c,fi(120)} = k_8 \cdot N_{Rk,c,fi(120)} \quad (\text{fire exposure between 90 and 120 mins}) \text{ EC2-4, Annex D, sect. D.4.3.2}$$

$k_8$  = the factor to be taken from the relevant ETA same as static loading (ambient temperature)

$N_{Rk,c,fi(90)}$ ,  $N_{Rk,c,fi(120)}$  are the reduced resistance values for fire as discussed earlier in this section. and generally, the value is not greater than static resistance value  $N_{Rk,c}$  (refer to Fig. 6.41). Similarly, pry-out resistance is also smaller for fire loading in comparison to static.

### Resistance against concrete edge failure

The characteristic resistance of a single anchor is defined as the resistance value for static loading multiplied by a reduction factor depending on the fire exposure duration.

$$V_{Rk,c,fi(90)}^0 = 0.25 \cdot V_{Rk,c}^0 \quad (\text{fire exposure } <90 \text{ mins}) \text{ EC2-4, Annex D, sect. D.4.3.3}$$

$$V_{Rk,c,fi(120)}^0 = 0.20 \cdot V_{Rk,c}^0 \quad (\text{fire exposure between 90 and 120 mins}) \text{ EC2-4, Annex D, sect. D.4.3.3}$$

$V_{Rk,c}^0$  is the initial value of the characteristic resistance of a single anchor in cracked concrete C20/25 under normal ambient temperature against concrete edge failure related to static shear.

### Design verification for combined action

Verification against combined action for fire loading follows the same formula as for static loading according to [Section 6.8](#).

#### 6.11.2 Design against fire condition as per EOTA TR 082

This technical report covers fire design of bonded anchors for one-sided fire exposure in cracked concrete of grade C20/25 to C50/60. However, only concrete C20/25 can be assumed in the design verifications. To consider fire design of bonded anchors as per EOTA TR 082 [46], anchors must have an ETA according to the EAD 330499 [22]. The design checks for all failure modes relevant for mechanical anchors as defined in EC2-4 [1] are applicable for bonded anchors designed using EOTA TR 082 [46]. The additional design check for bonded anchors, combined pull-out and concrete cone failure is exclusively defined in this technical report.

### Resistance against combined pull-out and cone failure for bonded anchors under tension load

EOTA TR 082 [46] recommends two different design methods for anchors under fire exposure:

- 1) Simplified method
- 2) Resistance Integration method

Here are some highlights of the two methods (Fig. 6.42).

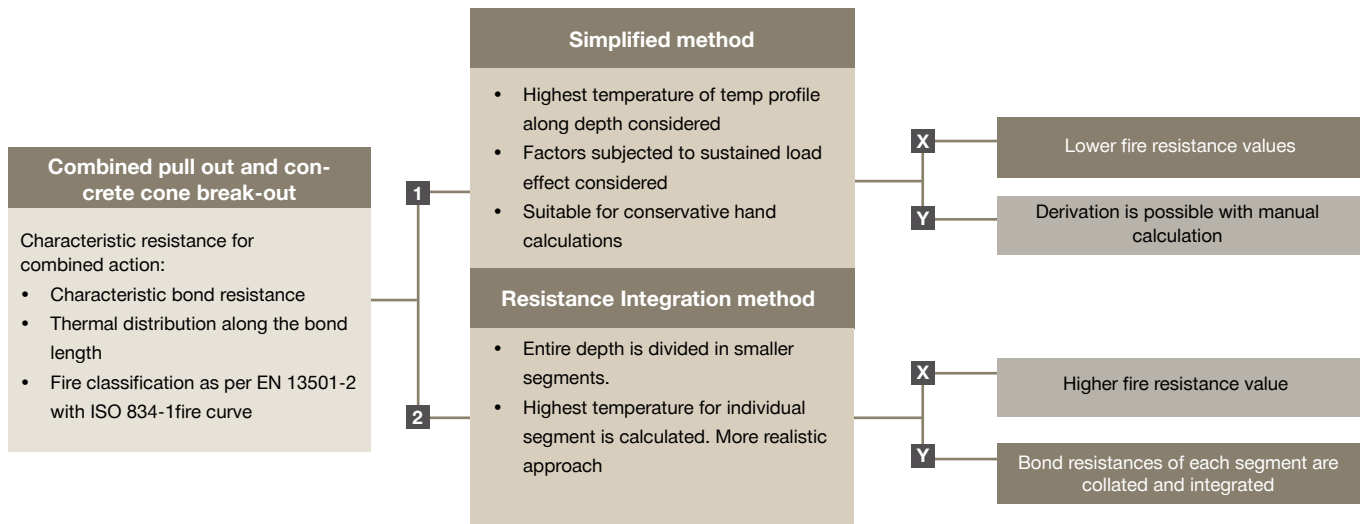

Fig. 6.42: Basic features of design method for combined pull-out and cone failure check in EOTA TR 082 [46]

The design resistance follows the general equation with relevant partial factor for fire. The characteristic resistance of an anchor,  $N_{Rk,p}$  is derived from the formula available for static loading.

### 6.11.2.1 Simplified method

In the simplified method, the highest temperature of the temperature profile along the embedment depth of the bonded anchor is used for determination of the resistance against combined pull-out and concrete failure under fire conditions.

$$N_{Rk,p,fi}^0 = \psi_{sus,fire} \cdot \tau_{Rk,p,fi,min} \cdot \pi \cdot d \cdot h_{ef} \quad \text{EOTA TR 082, eq (7.2)}$$

The characteristic bond resistance under fire conditions is defined as reduced static bond resistance at the corresponding highest temperature along the profile.

$$\tau_{Rk,p,fi,min} = k_{fi,p(\theta)} \cdot \tau_{Rk,cr} \quad \text{EOTA TR 082, eq (7.1)}$$

$k_{fi,p(\theta)}(20^\circ\text{C}) = 1.0$ . Therefore,  $\tau_{Rk,p,fi}(20^\circ\text{C}) = \tau_{Rk,cr}$

$k_{fi,p(\theta)}(21^\circ\text{C} \leq \theta \leq \theta_{max})$  is taken from the relevant ETA.

$k_{fi,p(\theta)}(\theta > \theta_{max}) = 0$ , sample graph for HIT-HY 200-A V3 chemical anchor showing reduction factor with respect to change in temperature under fire exposure is shown in Fig. 6.43.

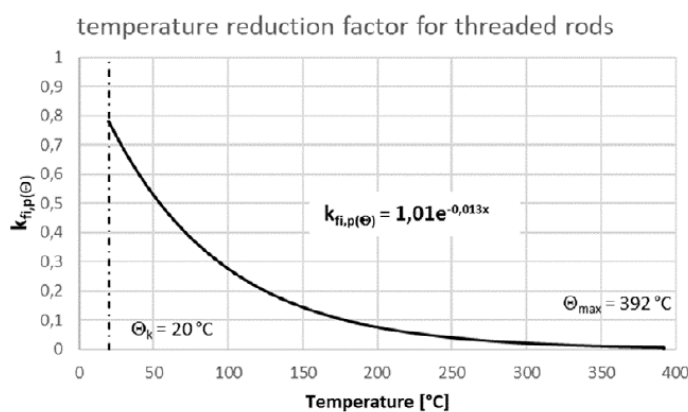

**Note:** More product-specific curves for temperature reduction curves can be found in relevant ETAs.

Fig. 6.43: Sample temperature reduction curve in ETA 19/0601 (Hilti HIT-HY 200-A V3 bonded anchor)

$\tau_{Rk,cr}$  = characteristic bond resistance for cracked concrete at normal ambient temperature for concrete strength class C20/25 to be taken from the ETA. For more information on product-specific graphs, the designer may check approved products of Hilti (FTM [29]) and ETAs.

$\psi_{sus,fire}$  is the factor for sustained load effect and  $\alpha_{sus,fire}$  is the ratio between sustained actions and total actions at ULS for fire.

$$\psi_{sus,fire} = 1 \text{ for } \alpha_{sus,fire} \leq \psi_{sus,fire}^0 \quad \text{EOTA TR 082, eq. (7.3)}$$

Proper justification is needed, if no value is mentioned in ETA,  $\psi_{sus,fire}^0 = \psi_{sus}^0$  is considered.

$$\psi_{sus,fire} = \psi_{sus,fire}^0 + 1 - \alpha_{sus,fire} \text{ for } \alpha_{sus,fire} > \psi_{sus,fire}^0 \quad \text{EOTA TR 082, eq. (7.4)}$$

### 6.11.2.2 Resistance integration method

This method follows a step-by-step calculation considering the reduction of bond resistance for each segment through the entire embedment length. The embedment depth is split into segments. Segment length  $\Delta x$  is lesser than  $2d$  and generally taken as  $10 \text{ mm}$ . The highest temperature for each segment is derived using polynomial equation of temperature curve. Bond resistance is calculated for each segment against corresponding highest temperatures. Final characteristic resistance is derived by integrating the bond resistances for each segment through the entire depth of the anchor.

The resistance to combined pull-out and concrete under fire conditions as per EOTA TR 082, eq. (7.5):

$$N_{Rk,p,fi}^0 = \pi \cdot d \cdot \psi_{sus,fire} \cdot \int_0^{h_{ef}} \tau_{Rk,p,fi} \cdot \theta(x) \cdot dx \approx \pi \cdot d \cdot \psi_{sus,fire} \cdot \sum_0^{h_{ef}} K_{fi,p} \cdot \theta(x) \cdot \tau_{Rk,cr} \cdot \Delta x$$

The characteristic bond resistance of a group of anchors under fire conditions is calculated with following parameters:

$$\tau_{Rk,p,ucr,fi} = \tau_{Rk,p,ucr} \cdot N_{Rk,p,fi}^0 / N_{Rk,p}^0 \quad \text{EOTA TR 082, eq. (7.6)}$$

$$\psi_{g,Np,fi} = 1 \quad \text{EOTA TR 082, sect. 7.2.3}$$

$$s_{cr,Np,fi} = 7.3d \cdot (\psi_{sus,fire} \cdot \tau_{Rk,p,ucr,fi})^{0.5} \leq 4 \cdot h_{ef} \quad \text{EC2-4, eq. (7.15), EOTA TR 082, eq. (7.7)}$$

$$\psi_{s,Np,fi} = 0.7 + 0.3 \cdot \left( \frac{c}{c_{cr,Np,fi}} \right) \leq 1 \quad \text{EC2-4, eq. (7.20), EOTA TR 082, eq. (7.9)}$$

**Note:** This method can be helpful for more optimized and efficient design of anchors for fire. Since manual calculation is complex and laborious, the use of PROFIS Engineering Suite (see [Chapter 7](#)) is recommended.

EOTA TR 082 [46] provides temperature distribution under fire conditions along the embedment depth of anchors to derive the bond resistance. The temperature profile for an anchor gets reduced with increasing embedment depth and it is highest at the top surface of contact between baseplate and concrete. Temperature profiles for common configurations of anchor diameter and embedment depth for fire exposure of 30, 60, 90 and 120 min are shown in EOTA TR 082 [46], Table A.1 and A.2. A third-degree polynomial relationship between temperature ( $T$ ) and position along the embedment depth of the anchor ( $x$ ) are expressed by following equation:

$$T(x) = a \cdot x^3 + b \cdot x^2 + c \cdot x + d \quad \text{EOTA TR 082, eq. (8.1)}$$

In the above equation,  $x$  is the embedment depth and  $a, b, c, d$  are factors corresponding to certain embedment depths and a particular fire exposure duration.

The temperature profile for a M12 anchor with embedment depth as 70, 90, 110 and 130 mm for fire

exposure duration of 60 mins, is shown below in Fig. 6.44 a). The temperature profile for a M12 anchor with embedment depth of 110 mm for fire exposure duration 30, 60, 90 and 120 mins is shown in Fig. 6.44 b). The graphs show that temperature gets reduced considerably with the increase in embedment depth.

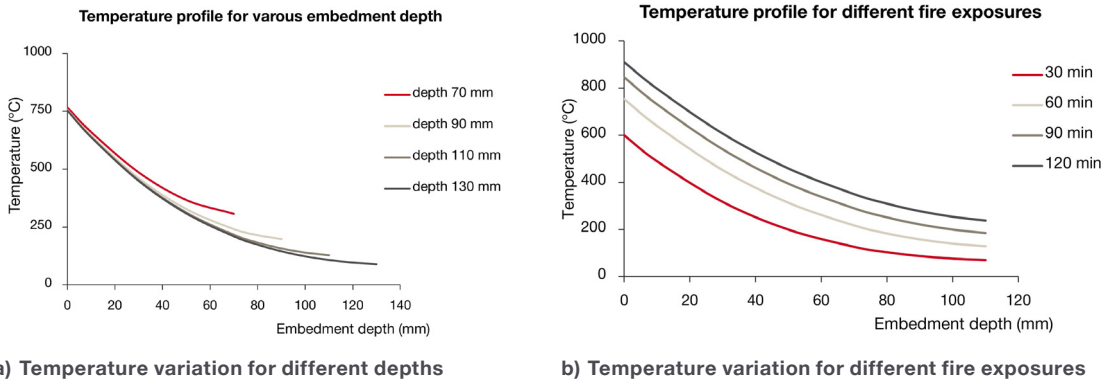
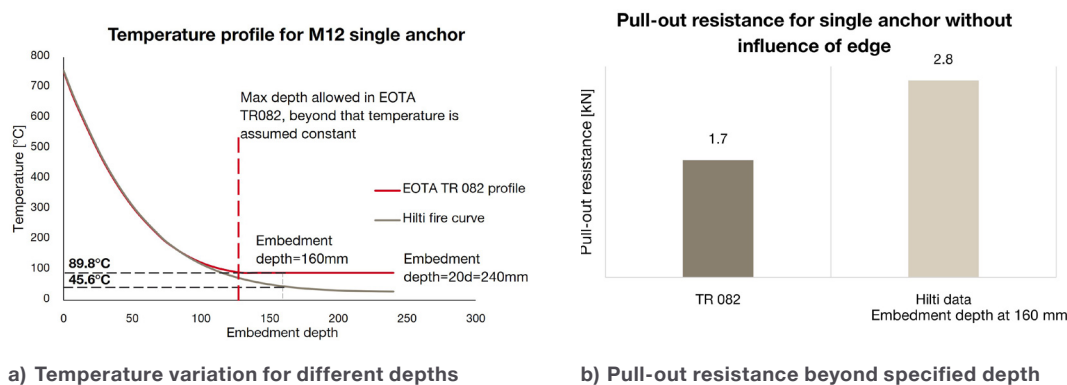

Fig. 6.44: Temperature reduction profile as per EOTA TR 082 [46] for a threaded rod M12

The temperature curves available in EOTA TR 082 [46] are limited to certain diameters and embedment depths. It is not allowed to interpolate or extrapolate for other possible length of anchors, for a depth beyond the value specified, temperature can be assumed to be constant. This is a conservative approach. **Hilti has developed more detailed fire curves and implemented them in the design software PROFIS Engineering** (see [Chapter 7](#)). They are available for a broad range of diameters and embedment depths (up to 20d) and the temperature profile is determined following the same principles of the curves included in the EOTA TR 082 [46]. This allows a more accurate calculation of the actual temperature than using the curves given in the EOTA TR 082 [46] for an anchor of specific diameter and embedment depth. The detailed calculation helps in taking advantage of temperature reduction with increasing depth in the design and hence it becomes more optimized and economical. An example is shown in Fig. 6.45. The temperature profile as per EOTA TR 082 [46] and Hilti fire data for a M12 anchor with embedment depth of 20d (240 mm) for fire exposure of 60 mins is shown in Fig. 6.45 a). As per EOTA TR 082 [46] the temperature is assumed to be constant as the extrapolation is not allowed (beyond 130 mm). As per Hilti data the temperature further reduces beyond the depth of 130 mm and at 240 mm depth the temperature is approximately 50% of the minimum value assumed as per EOTA TR 082 [46]. Using this reduced temperature, the resistance value is higher and hence it is possible to achieve more optimized solutions. The comparison of pull-out resistance for single M12 anchor between these two methods is shown in Fig. 6.45 b). The resistance against pull-out failure as per EOTA TR 082 [46] has been calculated considering the effective depth as 160 mm and the depth beyond 130 mm temperature is constant (89.8°C, refer to Fig. 6.45 a)). Pull-out resistance has been calculated for a depth of (160-130) mm = 30 mm. For the depth of 30 mm beyond 130 mm, pull-out resistance as per Hilti data has been calculated considering temperature reduction for each segment of 10 mm as per the available equation for temperature curves.

**Note:** Hilti Fire curves are based on the same principles of EOTA TR 082 but provide more detailed results.

**Note:** Hilti Fire curves consider same criteria for thermal and physical properties of bonded anchors as given in EOTA TR 082.



**Note:** Pull-out resistance has been calculated for HIT-RE 500 V4 anchor as per ETA 20/0541.

Fig. 6.45: Comparison between EOTA TR 082 [46] and Hilti developed data for a threaded rod M12

### 6.11.3 Design example of post-installed anchor against fire loading

#### 6.11.3.1 Design example of mechanical anchors

Project requirement: An I profile is attached to concrete slab with steel baseplate. The connection is established using mechanical anchors (Fig. 6.46).

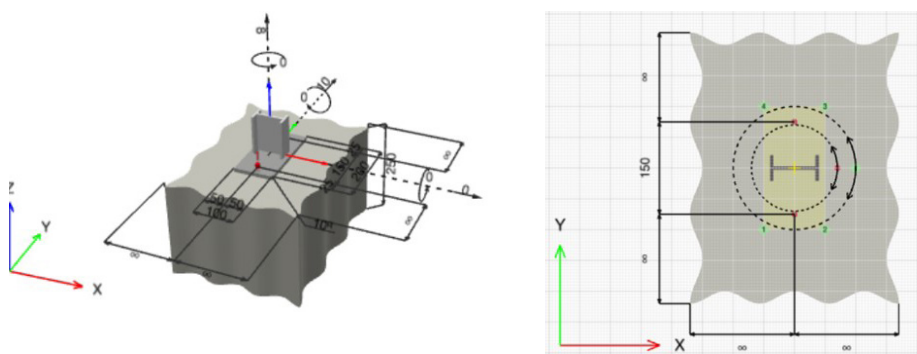

Fig. 6.46: Baseplate connection using post-installed mechanical anchors

#### Relevant project information:

Geometry of concrete:	Slab thickness, $h = 250 \text{ mm}$
Geometry of baseplate:	Plate dimension, $l \times w = 200 \times 100 \text{ mm}$ Plate thickness, $t = 15 \text{ mm}$
Materials:	Normal weight concrete C25/30, cracked Surface reinforcement with spacing of $100 \text{ mm}$ and diameter $\phi 12$
Loading:	Tension force, $N_{Ed} = 8 \text{ kN}$ Shear, $V_{Ed} = 10 \text{ kN}$ (no stand-off)
Steel profile:	I profile I 80 $L \times W \times T \times FT = 80 \times 42 \times 5.9 \times 5.9 \text{ mm}$
Design working life:	50 years
Fire exposure:	One side
Fire exposure duration:	60 mins

#### Details of post-installed anchors:

Type of anchor:	Mechanical
No of anchors:	2
Spacing between anchors in Y	$150 \text{ mm}$

Installation condition of post-installed anchors:

Drilling method/orientation: Rotary-hammer drilling/horizontal, dry  
 System/solution choice: Hilti HST4-R metal expansion anchor (ETA-21/0878 [36])

1) Analysis of tension and shear forces:

Total tension and shear forces on the anchor group,  $N_{Ed,fi} = 10\text{ kN}$  and  $V_{Ed,fi} = 10\text{ kN}$  and will be shared by two anchors. The summary is shown in Fig. 6.47.

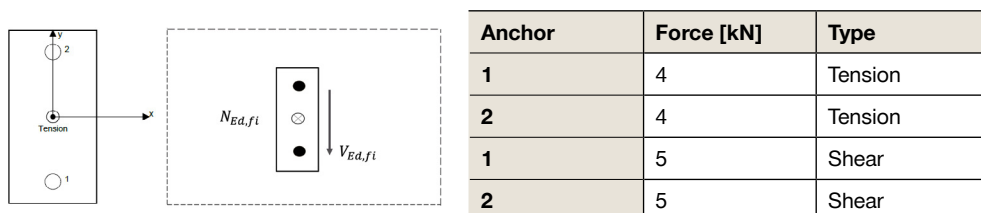



Fig. 6.47: Force analysis of anchors

2) Details of proposed anchor: the proposed anchor solution is described in Table 6.25.

Table 6.25: Anchor properties

Type of anchor	Mechanical	
Specification of anchor	HST4-R	
Diameter of anchor	$d$	12 mm
Effective embedment depth	$h_{ef}$	70 mm
Nominal embedment depth	$h_{nom}$	80 mm



Design verifications are carried considering rigid baseplate as per EC2-4 [1] and characteristic resistances are taken from ETA-21/0878 [36]. For details on the calculations of resistances against the different failure modes please refer to [Section 6.11.1](#).

Check of tension load failures:

Steel failure:

The resistance against steel failure is calculated for the most stressed anchor using the following equation:

$$N_{Rd,s,fi} = \frac{N_{Rk,s,fi}}{\gamma_{M,s,fi}} \quad \text{EC2-4, Table 7.1 Annex D, sect. D.4.2}$$

$$N_{Rk,s,fi} = 12.2\text{ kN} \quad \text{ETA-21/0878, Table C11}$$

$$\gamma_{M,s,fi} = 1.0 \quad \text{ETA-21/0878, Table C11}$$

$$N_{Rd,s,fi} = \left(\frac{12.2}{1.0}\right) = 12.2\text{ kN} > N_{Ed,fi} = 4\text{ kN} \quad \text{verification fulfilled} \checkmark$$

Pull-out failure:

The resistance against pull-out failure is calculated for highest loaded anchor by following expression:

$$N_{Rd,p,fi} = \frac{\psi_c \cdot N_{Rk,p,fi}}{\gamma_{M,p,fi}} \quad \text{EC2-4, eq. (7.1) Annex D, sect. D.4.2.3}$$

$$\psi_c = 1.0 \quad \text{C20/25 must be assumed in fire design}$$

$$N_{Rk,p,fi} = 7\text{ kN} \quad \text{ETA-21/0878, Table C11}$$

$$\gamma_{M,p,fi} = 1.0,$$

ETA-21/0878, Table C11

$$N_{Rd,p,fi} = \left(\frac{1 \cdot 7.0}{1.0}\right) = 7 \text{ kN} > N_{Ed,fi} = 4 \text{ kN}$$

verification fulfilled ✓

#### Concrete cone failure:

The resistance against concrete cone failure is checked for the entire anchor group with following equation:

$$N_{Rd,c,fi} = \frac{N_{Rk,c,fi}}{\gamma_{M,c,fi}} \quad \text{EC2-4, Table 7.1 Annex D, sect. D.4.2.2}$$

$$N_{Rk,c,for c20/25}^0 = k_1 \cdot \sqrt{f_{ck}} \cdot h_{ef}^{1.5} \quad \text{EC2-4, eq. (7.2)}$$

$$N_{Rk,c,for c20/25}^0 = 8.9 \cdot \sqrt{20} \cdot 70^{1.5} = 23.3 \text{ kN} \quad \text{ETA-21/0878, Table C11}$$

$$N_{Rk,c,fi}^0 = \frac{h_{ef}}{200} \cdot N_{Rk,c}^0 = \frac{70}{200} \cdot 23.3 = 8.2 \text{ kN} \quad \text{EC2-4, Annex D, eq. (D.2)}$$

$$s_{cr,N} = 2 \cdot c_{cr,N} = 4 \cdot h_{ef} = (4 \cdot 70) = 280 \text{ mm}, c_{cr,N} = 140 \text{ mm} \quad \text{EC2-4, sect. 7.2.1.4 (3)}$$

$$A_{c,N} = (140 + 150 + 140) \cdot (140 + 140) = 120,400 \text{ mm}^2 \quad \text{EC2-4, Fig. 7.4}$$

$$A_{c,N}^0 = s_{cr,N} \cdot s_{cr,N} = (280 \cdot 280) = 78,400 \text{ mm}^2 \quad \text{EC2-4, eq. (7.3)}$$

$$\psi_{s,N} = 0.7 + 0.3 \cdot \frac{c}{c_{cr,N}} \leq 1, \text{ hence } \psi_{s,N} = 1.0 \text{ for infinite edge distance} \quad \text{EC2-4, eq. (7.4)}$$

$$\psi_{re,N} = 0.5 + \frac{h_{ef}}{200} \leq 1.0 \quad \text{EC2-4, eq. (7.5)}$$

$$\psi_{re,N} = 0.5 + \frac{70}{200} = 0.85$$

$$\psi_{ec,N} = \frac{1}{1 + \left(\frac{2 \cdot e_{c,N}}{s_{cr,N}}\right)} \quad \text{EC2-4, eq. (7.6)}$$

Factors for eccentricity are calculated along two axes, X and Y. Eccentricity along X and Y axes

$$e_{c,N} = 0 \text{ mm, hence, } \psi_{ec,N} = 1.0. \text{ Factor for bending moment, } \psi_{M,N} = 1.0$$

$$N_{Rk,c,fi} = N_{Rk,c,fi}^0 \cdot \frac{A_{c,N}}{A_{c,N}^0} \cdot \psi_{s,N} \cdot \psi_{re,N} \cdot \psi_{ec,N} \cdot \psi_{M,N} = 8.2 \cdot \left(\frac{120,400}{78,400}\right) \cdot 1.0 \cdot 0.85 \cdot 1.0 \cdot 1.0 = 10.7 \text{ kN}$$

$$N_{Rd,c,fi} = \left(\frac{10.7}{1.0}\right) = 10.7 \text{ kN} > N_{Ed,fi} = 8 \text{ kN} \quad \text{verification fulfilled ✓}$$

#### Concrete splitting failure:

With reference to the criteria given in EC2-4 [1], sect. 7.2.1.7 (2) b) 2), the splitting failure is resisted by reinforcement in concrete with limitation in crack width of  $w_k \leq 0.3 \text{ mm}$ .

#### Check of shear load failures:

##### Steel failure:

The resistance against steel failure is calculated for the most stressed anchor using the following equation:

$$V_{Rd,s,fi} = \frac{V_{Rk,s,fi}}{\gamma_{Ms,fi}} \quad \text{EC2-4, Table 7.2 Annex D, sect. D.4.3.1}$$

$$\gamma_{Ms,fi} = 1.0$$

ETA-21/0878, Table C12

$$V_{Rk,s,fi} = 12.2 \text{ kN}$$

ETA-21/0878, Table C12

$$V_{Rd,s,fi} = \left(\frac{12.2}{1.0}\right) = 12.2 \text{ kN} > V_{Ed,fi} = 5 \text{ kN}$$

verification fulfilled ✓



Concrete pry-out failure:

The resistance against concrete pry-out failure is calculated for the group of anchors:

$$V_{Rk,cp,fi} = k_8 \cdot N_{Rk,c,fi} \quad \text{EC2-4, eq. (7.39a) Annex D, eq. (D.8)}$$

$$V_{Rd,cp,fi} = \frac{V_{Rk,cp,fi}}{\gamma_{Mcp,fi}} \quad \text{EC2-4, Table 7.2}$$

$$\gamma_{Mcp,fi} = 1.0 \quad \text{ETA-21/0878, Table C12}$$

$$k_8 = 2.74 \quad \text{ETA-21/0878, Table C2}$$

The characteristic resistance of a single anchor is taken from the check of concrete cone failure:

$$N_{Rk,c,fi}^0 = 8.2 \text{ kN}, \psi_{s,N} = 1.0, \psi_{re,N} = 1.0 \text{ [same as concrete cone failure]}, \psi_{ec,N} = 1.0$$

$$N_{Rk,c,fi} = N_{Rk,c,fi}^0 \cdot \frac{A_{c,N}}{A_{c,N}^0} \cdot \psi_{s,N} \cdot \psi_{re,N} \cdot \psi_{ec,N} = 8.2 \cdot \left(\frac{120,400}{78,400}\right) \cdot 1.0 \cdot 0.85 \cdot 1.0 \cdot 1.0 = 10.7 \text{ kN}$$

$$V_{Rk,cp,fi} = 10.7 \cdot 2.74 = 29.3 \text{ kN}$$

$$V_{Rd,cp,fi} = \left(\frac{29.3}{1.0}\right) = 29.3 \text{ kN} > V_{Ed,fi} = 10 \text{ kN} \quad \text{verification fulfilled} \checkmark$$

Check for combined tension and shear load:

Steel failure: EC2-4, Annex D, sect. D.4.4

$$\text{Ratio between action load and resistance in tension, } \beta_N = \left(\frac{4}{12.2}\right) = 0.33 \leq 1.0$$

$$\text{Ratio between action load and resistance in shear, } \beta_v = \left(\frac{5}{12.2}\right) = 0.41 \leq 1.0$$

$$\beta_N^\alpha + \beta_v^\alpha = 0.33^2 + 0.41^2 = 0.28 \leq 1.0 \quad \text{verification fulfilled} \checkmark$$

Failure other than steel: EC2-4, Annex D, sect. D.4.4

$$\text{Ratio between action load and resistance in tension, } \beta_N = \left(\frac{8}{10.7}\right) = 0.75 \leq 1.0$$

$$\text{Ratio between action load and resistance in shear, } \beta_v = \left(\frac{10}{29.3}\right) = 0.34 \leq 1.0$$

$$\beta_N^\alpha + \beta_v^\alpha = 0.75^{1.5} + 0.34^{1.5} = 0.85 \leq 1.0 \quad \text{verification fulfilled} \checkmark$$

**6.11.3.2 Design example of chemical anchors**

The project requirement is same as for mechanical anchors (except the loading condition) (Fig. 6.48).

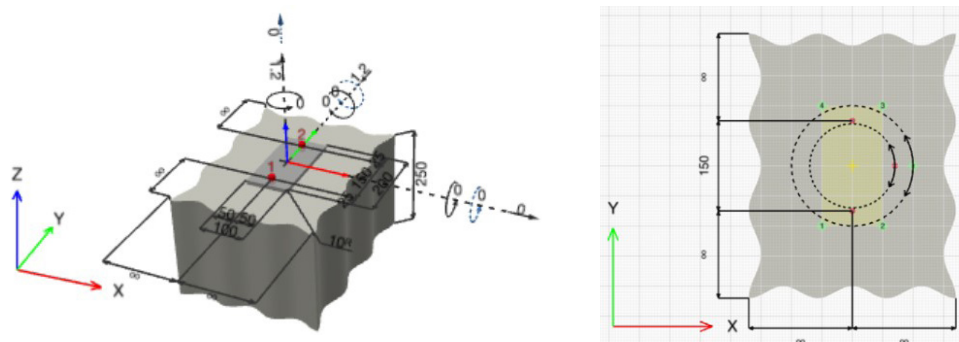

Fig. 6.48: Baseplate connections using post-installed chemical anchors

1) Analysis of tension and shear forces:

Total tension force on anchor group,  $N_{Ed,fi} = 1.2 \text{ kN}$  and  $V_{Ed,fi} = 1.2 \text{ kN}$  and will be shared by two anchors. The summary is shown in Fig. 6.49.

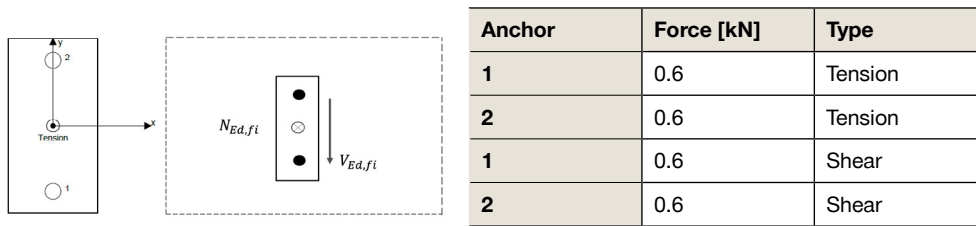

Fig. 6.49: Force analysis of anchors

2) Details of proposed anchor: The chemical anchor as proposed alternatively is defined in Table 6.26.

Table 6.26: Anchor properties

Type of anchor	Chemical	
Specification of anchor	HIT-RE 500 V4 + HAS-U	
Diameter of anchor	$d$	16 mm
Effective embedment depth	$h_{ef}$	140 mm

Design verifications are carried considering rigid baseplate as per EC2-4 [1], EOTA TR 082 [46] and characteristic resistances are taken from ETA-20/0541 [47]. For details on the calculations of resistances against different failure modes please refer to [Section 6.11.2](#).

Check of tension load failures:

Steel failure:

The resistance against steel failure is calculated for most stressed anchor using following equation:

$$N_{Rd,s,fi} = \frac{N_{Rk,s,fi}}{\gamma_{M,s,fi}} \quad \text{EC2-4, Table 7.1 Annex D, sect.D.4.2}$$

$$N_{Rk,s,fi} = 3.79 \text{ kN} \quad \text{ETA-20/0541, Table C39}$$

$$\gamma_{M,s,fi} = 1.0 \quad \text{ETA-20/0541, Table C39}$$

$$N_{Rd,s,fi} = \left(\frac{3.79}{1.0}\right) = 3.79 \text{ kN} > N_{Ed,fi} = 0.6 \text{ kN} \quad \text{verification fulfilled} \checkmark$$

Combined pull-out and concrete cone failure:

Combined pull-out and concrete cone failure is checked using equations from EOTA TR 082 [46]. Here the design is done as per ‘‘Simplified method’’ (refer to [Section 6.11.2](#)) as it is easier to do manually. Further comparison will be done between the results for ‘‘Simplified method’’ and ‘‘Resistance integration method’’. The design example considering ‘‘Resistance integration method’’ will be carried out using PROFIS Engineering software (refer to [Chapter 7](#)).

$$N_{Rd,p,fi} = \frac{N_{Rk,p,fi}}{\gamma_{M,p,fi}} \quad \text{EC2-4, Table 7.1, Annex-C, sect. C.5}$$

The characteristic resistance of an anchor in case of pull-out failure,  $N_{Rk,p}$  is:

$$\tau_{Rk,p,fi \text{ min}} = k_{fi,p(\theta)} \cdot \tau_{Rk,cr} \quad \text{EOTA TR 082, eq. (7.1)}$$

Using the temperature profile from EOTA TR 082 [46], we get max temperature of 167°C at 110 mm embedment depth. Hence, effective depth where bond resistance can be considered is (140-110) = 30 mm, see Fig. 6.50.

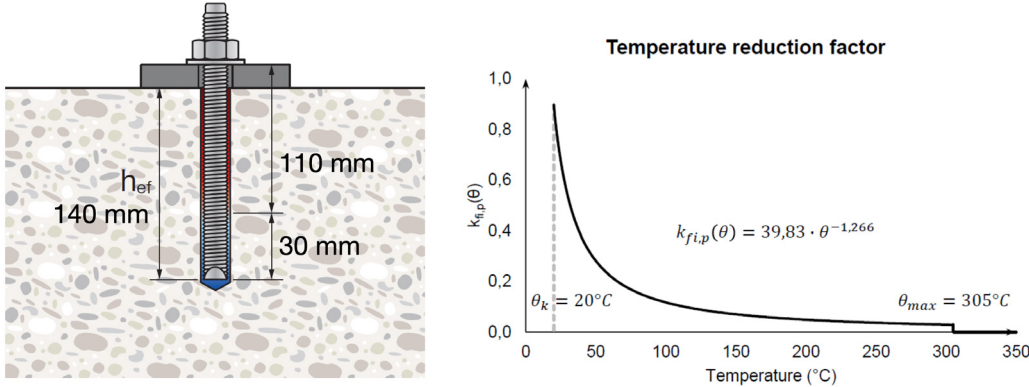

Fig. 6.50: Temperature profile considered in Simplified method

$$k_{fi,p}(\theta) = 39.83 \cdot \theta^{-1.266}$$

ETA-20/0541 [46], Fig. C.5.

$$\tau_{Rk,cr} = 11.0 \text{ MPa}$$

ETA-20/0541, Table C1

$$k_{fi,p}(\theta) = 39.83 \cdot \theta^{-1.266} = 39.83 \cdot 167^{-1.266} = 0.061$$

$$\tau_{Rk,p,fi \text{ min}} = 0.061 \cdot 11 = 0.67 \text{ MPa}$$

$$\psi_{sus}^0 = 0.88, \alpha_{sus,fi} = 0.5$$

ETA-20/0541, Table C2

$$\psi_{sus,fire} = 1.0$$

EOTA TR 082, eq. (7.3)

$$N_{Rk,p,fi}^0 = \psi_{sus,fire} \cdot \tau_{Rk,p,fi \text{ min}} \cdot \pi \cdot d \cdot h_{ef} = 1.0 \cdot 0.67 \cdot \pi \cdot 16 \cdot 30$$

EOTA TR 082, eq. (7.2)

$$N_{Rk,p,fi}^0 = 1.01 \text{ kN}$$

$$\tau_{Rk,p,ucr} = 17 \text{ MPa}$$

ETA-20/0541, Table C1

$$N_{Rk,p}^0 = \psi_{sus} \cdot \tau_{Rk,cr} \cdot \pi \cdot d \cdot h_{ef} = 1 \cdot 11 \cdot \pi \cdot 16 \cdot 140 = 77.4 \text{ kN}$$

EC2-4, eq. (7.14)

$$\tau_{Rk,p,ucr,fi} = \tau_{Rk,p,ucr} \cdot N_{Rk,p,fi}^0 / N_{Rk,p}^0 = 17 \cdot \frac{1.01}{77.4} = 0.22 \text{ MPa}$$

EOTA TR 082, eq. (7.6)

$$s_{cr,Np,fi} = 7.3d \cdot (\psi_{sus,fire} \cdot \tau_{Rk,p,ucr,fi})^{0.5} = 7.3 \cdot 16 \cdot (1 \cdot 0.22)^{0.5} = 55.1$$

$$s_{cr,Np,fi} = 55.1 < 4 \cdot 140 = 560 \text{ mm}$$

EOTA TR 082, eq. (7.7)

$$c_{cr,Np,fi} = s_{cr,Np,fi} / 2 = (55.1 / 2) = 27.6 \text{ mm}, \psi_{g,Np,fi} = 1.0,$$

$$\text{Eccentricity: } e_N = 0, \psi_{ec,Np,fi} = 1.0$$

$$\psi_{s,Np,fi} = 0.7 + 0.3 \cdot \left( \frac{c}{c_{cr,Np,fi}} \right), \psi_{s,Np,fi} = 1, \psi_{re,N,fi} = 1.0$$

$$A_{p,N,fi}^0 = s_{cr,Np,fi} \cdot s_{cr,Np,fi} = 55.1 \cdot 55.1 = 3,038 \text{ mm}^2 \quad A_{p,N,fi} = (55.1 \cdot 55.1) = 3,038 \text{ mm}^2$$

$$N_{Rk,p,fi} = N_{Rk,p,fi}^0 \cdot \frac{A_{p,N}}{A_{p,N}^0} \cdot \psi_{g,Np,fi} \cdot \psi_{s,Np,fi} \cdot \psi_{re,N,fi} \cdot \psi_{ec,Np,fi} = 1.01 \cdot \frac{3,038}{3,038} \cdot 1.0 \cdot 1.0 \cdot 1.0 \cdot 1.0$$

$$N_{Rk,p,fi} = 1.01 \text{ kN}$$

EC2-4, eq. (7.13)

$$N_{Rd,p,fi} = \left( \frac{1.01}{1.0} \right) = 1.01 \text{ kN} > N_{Ed,fi} = 0.6 \text{ kN}$$

verification fulfilled ✓

**Note:** Resistances are calculated assuming currently available temp. profiles provided in the current version of EOTA TR 082.

**Note:** Exact values might be different in the future, as EOTA TR 082 will provide new temp. profiles covering more geometries.

#### Concrete cone failure:

The resistance against concrete cone failure is checked for the entire anchor group with the following equation:

$$N_{Rd,c,fi} = \frac{N_{Rk,c,fi}}{\gamma_{Mc,fi}}$$

EC2-4, Table 7.1 Annex D, Section D.4.2.2

$$N_{Rk,c \text{ for } C20/25}^0 = k_1 \cdot \sqrt{f_{ck}} \cdot h_{ef}^{1.5} = 7.7 \cdot \sqrt{20} \cdot 140^{1.5} = 57 \text{ kN}$$

EC2-4, eq. (7.2)

$$N_{Rk,c,fi}^0 = \frac{h_{ef}}{200} \cdot N_{Rk,c}^0 < N_{Rk,c}^0, N_{Rk,c,fi}^0 = \frac{140}{200} \cdot 57 = 39.9 \text{ kN} \quad \text{EC2-4, Annex D, eq. (D.2)}$$

$$s_{cr,N} = 2 \cdot c_{cr,N} = 4 \cdot h_{ef} = (4 \cdot 140) = 560 \text{ mm}, c_{cr,N} = 280 \text{ mm} \quad \text{EC2-4, sect. 7.2.1.4 (3)}$$

$$A_{c,N} = (280 + 150 + 280) \cdot (280 + 280) = 397,600 \text{ mm}^2 \quad \text{EC2-4, Fig. 7.4}$$

$$A_{c,N}^0 = s_{cr,N} \cdot s_{cr,N} = (560 \cdot 560) = 313,600 \text{ mm}^2 \quad \text{EC2-4, eq. (7.3)}$$

$$\psi_{s,N} = 0.7 + 0.3 \cdot \frac{c}{c_{cr,N}} = 0.7 + 0.3 \cdot \left(\frac{280}{280}\right) = 1.0 \quad \text{EC2-4, eq. (7.4)}$$

$$\psi_{re,N} = 0.5 + \frac{h_{ef}}{200} \leq 1.0 \quad \text{EC2-4, eq. (7.5)}$$

$$\psi_{re,N} = 1.0 \text{ because } h_{ef} > 100 \text{ mm}$$

$$\psi_{ec,N} = \frac{1}{1 + \left(\frac{2 \cdot e_{c,N}}{s_{cr,N}}\right)} \quad \text{EC2-4, eq. (7.6)}$$

Eccentricity along X and Y axes  $e_{c,N} = 0 \text{ mm}$ , hence  $\psi_{ec,N} = 1.0$

$$\text{Factor for bending moment, } \psi_{M,N} = 1.0 \quad \text{EC2-4, eq. (7.7)}$$

$$N_{Rk,c,fi} = N_{Rk,c,fi}^0 \cdot \frac{A_{c,N}}{A_{c,N}^0} \cdot \psi_{s,N} \cdot \psi_{re,N} \cdot \psi_{ec,N} \cdot \psi_{M,N} = 39.9 \cdot \left(\frac{397,600}{313,500}\right) \cdot 1.0 \cdot 1.0 \cdot 1.0 \cdot 1.0 = 50.6 \text{ kN}$$

$$N_{Rd,c,fi} = \left(\frac{50.6}{1.0}\right) = 50.6 \text{ kN} > N_{Ed,fi} = 1.2 \text{ kN} \quad \text{verification fulfilled } \checkmark$$

#### Concrete splitting failure:

With reference to the criteria given in EC2-4 [1], sect. 7.2.1.7 (2) b) 2), the splitting failure is resisted by reinforcement in concrete with limitation in crack width of  $w_k \leq 0.3 \text{ mm}$ .

#### Check of shear load failures:

##### Steel failure:

The resistance against steel failure is calculated for the most stressed anchor using the following equation:

$$V_{Rd,s,fi} = \frac{V_{Rk,s,fi}}{\gamma_{Ms,fi}} \quad \text{EC2-4, Table 7.2 Annex D, sect. D.4.3.1}$$

$$\gamma_{Ms,fi} = 1.0 \quad \text{ETA-20/0541, Table C42}$$

$$V_{Rk,s,fi} = 3.79 \text{ kN} \quad \text{ETA-20.0541, Table C42}$$

$$V_{Rd,s,fi} = \left(\frac{3.79}{1.0}\right) = 3.79 \text{ kN} > V_{Ed,fi} = 0.6 \text{ kN} \quad \text{verification fulfilled } \checkmark$$

##### Concrete pry-out failure:

The resistance against concrete pry-out failure is calculated for the group of anchors:

$$V_{Rk,cp,fi} = k_8 \cdot N_{Rk,c,fi} \quad \text{EC2-4, eq. (7.39a) Annex D, eq. (D.8)}$$

$$V_{Rd,cp,fi} = \frac{V_{Rk,cp,fi}}{\gamma_{Mcp,fi}} \quad \text{EC2-4, Table 7.2}$$

$$\gamma_{Mcp,fi} = 1.0 \quad \text{ETA-20/0541, Table C42}$$

$$k_8 = 2.0 \quad \text{ETA-20/0541, Table C7}$$

The characteristic resistance of single anchor is taken from the check of concrete cone failure:

$$N_{Rk,c,fi}^0 = 1.01 \text{ kN},$$

$$\psi_{s,Np,fi} = 1.0, \psi_{re,Np,fi} = 1.0, \psi_{ec,N} = 1.0$$

$$N_{Rk,c,fi} = N_{Rk,c,fi}^0 \cdot \frac{A_{c,N}}{A_{c,N}^0} \cdot \psi_{s,Np,fi} \cdot \psi_{re,Np,fi} \cdot \psi_{ec,Np,fi} = 1.01 \cdot \left(\frac{3,038}{3,038}\right) \cdot 1.0 \cdot 1.0 \cdot 1.0 = 1.01 \text{ kN}$$

$$V_{Rk,cp,fi} = 1.01 \cdot 2 = 2.02 \text{ kN}$$

$$V_{Rd,cp,fi} = \left(\frac{2.02}{1.0}\right) = 2.02 \text{ kN} > V_{Ed,fi} = 1.2 \text{ kN}$$

verification fulfilled ✓

Check for combined tension and shear load:

Steel failure:

EC2-4, Annex D, sect. D.4.4

$$\text{Ratio between action load and resistance in tension, } \beta_N = \left(\frac{0.6}{3.79}\right) = 0.16 \leq 1.0$$

$$\text{Ratio between action load and resistance in shear, } \beta_v = \left(\frac{0.6}{3.79}\right) = 0.16 \leq 1.0$$

$$\beta_N^\alpha + \beta_v^\alpha = 0.16^2 + 0.16^2 = 0.05 \leq 1.0$$

verification fulfilled ✓

Failure other than steel:

EC2-4, Annex D, sect. D.4.4

$$\text{Ratio between action load and resistance in tension, } \beta_N = \left(\frac{0.6}{1.01}\right) = 0.59 \leq 1.0$$

$$\text{Ratio between action load and resistance in shear, } \beta_v = \left(\frac{1.2}{2.02}\right) = 0.59 \leq 1.0$$

$$\beta_N^\alpha + \beta_v^\alpha = 0.59^{1.5} + 0.59^{1.5} = 0.91 \leq 1$$

verification fulfilled ✓

Now the same design example is checked in PROFIS Engineering for “Resistance integration method”.

The design check varies for combined pull-out and concrete cone failure; hence the design calculation is shown against this failure below.

Combined pull-out and concrete cone failure:

$$N_{Rd,p,fi} = \frac{N_{Rk,p,fi}}{\gamma_{M,p,fi}}$$

EC2-4, Table 7.1, Annex-C, sect. C.5

$$N_{Rk,p,fi}^0 = \pi \cdot d \cdot \psi_{sus,fire} \cdot \int_0^{h_{ef}} \tau_{Rk,p,fi} \cdot \theta(x) \cdot dx$$

$$N_{Rk,p,fi}^0 \approx \pi \cdot d \cdot \psi_{sus,fire} \cdot \sum_0^{h_{ef}} K_{fi,p} \cdot \theta(x) \cdot \tau_{Rk,cr} \cdot \Delta x$$

EOTA TR 082, eq. (7.5)

$$\tau_{Rk,cr} = 11.0 \text{ MPa}$$

ETA-20/0541, Table C1

$$\psi_{sus}^0 = 0.88, \alpha_{sus} = 0,$$

ETA-20/0541, Table C2

$$\psi_{sus,fire} = 1.0$$

EOTA TR 082, eq. (7.3)

$$\tau_{Rk,p,ucr} = 17 \text{ MPa}$$

ETA-20/0541, Table C1

$$\tau_{Rk,p,ucr,fi} = \tau_{Rk,p,ucr} \cdot N_{Rk,p,fi}^0 / N_{Rk,p}^0 = 0.7 \text{ MPa}$$

EOTA TR 082, eq. (7.6)

$$s_{cr,Np,fi} = 7.3d \cdot (\psi_{sus,fire} \cdot \tau_{Rk,p,ucr,fi})^{0.5} = 7.3 \cdot 16 \cdot (1.0 \cdot 0.7)^{0.5}$$

$$s_{cr,Np,fi} = 97.5 < 4 \cdot 140 = 560 \text{ mm}$$

EOTA TR 082, eq. (7.7)

$$c_{cr,Np,fi} = s_{cr,Np,fi} / 2 = (97.5/2) = 48.8 \text{ mm}$$

$$\psi_{g,Np,fi} = 1.0,$$

$$\text{Eccentricity, } e_N = 0, \psi_{ec,Np,fi} = 1.0$$

$$\psi_{s,Np,fi} = 0.7 + 0.3 \cdot \left(\frac{c}{c_{cr,Np,fi}}\right) = 1.0, \psi_{s,Np,fi} = 1.0, \psi_{re,Np,fi} = 1.0$$

$$A_{p,N,fi}^0 = s_{cr,Np,fi} \cdot s_{cr,Np,fi} = (97.5 \cdot 97.5) = 9,510 \text{ mm}^2$$

$$A_{p,N,fi} = (97.5 \cdot 97.5) = 9,510 \text{ mm}^2$$

$$N_{Rk,p,fi}^0 = \pi \cdot d \cdot \psi_{sus,fire} \cdot \int_0^{h_{ef}} \tau_{Rk,p,fi} \cdot \theta(x) \cdot dx \approx \pi \cdot d \cdot \psi_{sus,fire} \cdot \sum_0^{h_{ef}} K_{fi,p} \cdot \theta(x) \cdot \tau_{Rk,cr} \cdot \Delta x = 3.2 \text{ kN}$$

$$N_{Rk,p,fi} = N_{Rk,p,fi}^0 \cdot \frac{A_{p,N}}{A_{p,N}^0} \cdot \psi_{g,Np,fi} \cdot \psi_{s,Np,fi} \cdot \psi_{re,Np,fi} \cdot \psi_{ec,Np,fi} = 3.2 \cdot \frac{9,510}{9,510} \cdot 1.0 \cdot 1.0 \cdot 1.0 \cdot 1.0$$

$$N_{Rk,p,fi} = 3.2 \text{ kN}$$

EC2-4, eq. (7.13)

$$N_{Rd,p,fi} = \left(\frac{3.2}{1.0}\right) = 3.2 \text{ kN} > N_{Ed,fi} = 0.6 \text{ kN}$$

verification fulfilled ✓

**Note:** Finally, utilization for combined tension and shear loading is 12%. Furthermore, using the detailed “Resistance integration method”, the reduction in diameter and embedment depth is approx. 25-30%. Therefore, there is room for optimization, e.g., using smaller/shorter anchors.

The optimized anchor dimensions and results are shown in Table 6.27:

Table 6.27: Summary of utilization ratio for optimized anchor solution

Load direction	Failure modes	Utilization [%] – HIT-RE 500 V4 + HAS-U M12, $h_{ef} = 97 \text{ mm}$
Tension	Steel	30
	Concrete cone	6
	Combined pull-out and concrete cone	80
Shear	Steel	30
	Concrete edge	40
Combination	Steel	18
	Failure other than steel	97

## 6.12 Design against fatigue condition as per EC2-4 and EOTA TR 061

The dynamic loads need to be distinguished between seismic, shock and fatigue depending on frequency of occurrence, amplitude and the rate of application. The key features of these three dynamic actions are described in Fig. 3.12 and [Section 3.5](#). Fatigue-relevant applications include cranes, elevators, robots, bridge and tunnel components, hoisting equipment etc.

### 6.12.1 Design scope and verification according to EC2-4 and EOTA TR 061

Fatigue design of post-installed anchors is covered by EC2-4 [1] including checks for tension, shear and combined action relevant failure modes. **EOTA TR 061** [24] provides more refined design provisions against **fatigue cyclic loading in combination with or without static or quasi-static loading** and giving the **possibility to account for the expected number of dynamic cycles** during the design working life of the connection. Both the design standard and technical report address the design of post-installed anchors for same range of concrete classes (C20/25 to C50/60) and cracked/uncracked condition. Annular gaps are not allowed, and the Hilti filling set can be used to fill the gaps (see [Section 5.1.4](#)). The main differences between EC2-4 [1] and EOTA TR 061 [24] are shown in Table 6.28.

Table 6.28: Comparison between EC2-4 [1] and EOTA TR 061 [24]

Parameters		Scope in EC2-4	Scope in EOTA TR 061
<b>Basic guideline for fatigue consideration</b>	Minimum number of cycles that require fatigue verification	No requirement is defined	1) $n > 1000$ load cycles for pulsating tension loads 2) $n > 100$ load cycles for alternating or pulsating shear loads
	Fatigue verification for impact of climatic variation and restraint forces on anchor	Nothing is specified against the criteria	Verification is required if, $\Delta\sigma_{Sk} = \sigma_{Sk,max} - \sigma_{Sk,min} \geq 100 \text{ N/mm}^2$ (in case of tension) $\Delta\tau_{Sk} = \tau_{Sk,max} - \tau_{Sk,min} \geq 60 \text{ N/mm}^2$ (in case of shear)
	Provision for annular gaps	Annular gap is not allowed	Scope is same as per EC2-4
	Shear loads for fatigue	Shear load without lever arm is only included in scope	Scope is same as per EC2-4
<b>Design methods and concept of fatigue resistance</b>	Design method	Single design method for calculation of design resistance against tension and shear relevant failures	Two design methods; Complete method and Simplified method (refer to <a href="#">Sections 6.12.2.1</a> and <a href="#">6.12.2.2</a> )
	Assessment method/ ETA	Generic reference to ETAs	Refer to relevant ETA according to specific EAD 330250 (refer also to Table 6.35)
	Effective embedment depth of chemical anchors	It does not define any specific criteria for this	It defines the reduction in effective depth below concrete surface as $h_{ef, fat} = h_{ef} - \Delta h_{ef}$ and $\Delta h_{ef} = \max(1.25 \cdot d, 25 \text{ mm})$
	Concept for design of fasteners with fatigue influence	Nothing is addressed or mentioned in detail	Precise description on fatigue resistance (refer to Table 6.34 for details).
	Superimposition of static and fatigue cyclic loads	Nothing is specified on this topic	5 different cases are defined based on static and fatigue loading (EOTA TR 061, sect. (2.2.2)) considering the Goodman diagram (see Fig. 6.52)
	Consideration of maximum expected number of cycles	Nothing is specified on this topic	Design methods for 1) endurance levels ( $\infty$ number of cycles); Refer to <a href="#">Section 6.12.2.1</a>
<b>Verifications</b>	Combined pull-out and concrete cone	Scope does not include this check	$\frac{\Delta N_{Ed}}{\Delta N_{Rd,p,E,n}} \leq 1$
	Exponents for combined tension and shear	$\alpha_s, \alpha_c$ are considered from ETA	$\alpha_s \leq 2.0$ and is considered from product relevant ETA. $\alpha_c = 1.5$ or can be taken from ETA
	Concrete cone and splitting failure	$0.5 N_{Rk,c}$ for $2 \times 10^6$ load cycles	No specific value is mentioned, verification is as per previous equation
	Concrete pry-out and edge failure	Pry-out failure - $0.5 V_{Rk,cp}$ for $2 \times 10^6$ load cycles. Edge failure - $0.5 V_{Rk,c}$ for $2 \times 10^6$ load cycles	No specific value is mentioned, verification is required as per previous equation
	Concrete edge break-out	Only loading towards the edge is considered	Both loading towards and away from the edge is considered (refer to Fig. 6.51)

**Note:** Under fatigue condition, shear load with lever arm is not covered by EC2-4 and EOTA TR 061.

Design verifications against tension, shear and combined load as defined in EOTA TR 61 [24] are shown in Table 6.29, Table 6.30, Table 6.31.

Table 6.29: Failure modes and criteria against tension load in EOTA TR 061 [24]

Failure modes	Single anchor	Group of anchors	
		Most loaded anchor	Group
Steel failure	$\Delta N_{Ed} / \Delta N_{Rd,s,E,n} \leq 1.0$	$\Delta N_{Ed} / \psi_{FN} \cdot \Delta N_{Rd,s,E,n} \leq 1.0$	
Concrete cone failure	$\Delta N_{Ed} / \Delta N_{Rd,c,E,n} \leq 1.0$		$\Delta N_{Ed} / \Delta N_{Rd,c,E,n} \leq 1.0$
Pull-out failure	$\Delta N_{Ed} / \Delta N_{Rd,p,E,n} \leq 1.0$	$\Delta N_{Ed} / \psi_{FN} \cdot \Delta N_{Rd,p,E,n} \leq 1.0$	
Concrete splitting failure	$\Delta N_{Ed} / \Delta N_{Rd,sp,E,n} \leq 1.0$		$\Delta N_{Ed} / \Delta N_{Rd,sp,E,n} \leq 1.0$
Combined concrete-cone / pull-out failure	$\Delta N_{Ed} / \Delta N_{Rd,p,E,n} \leq 1.0$		$\Delta N_{Ed} / \Delta N_{Rd,p,E,n} \leq 1.0$

**Note:** Fatigue testing proves that steel failure is usually more relevant than adhesive bond strength or concrete related failure modes.

Table 6.30: Failure modes and criteria against shear load in EOTA TR 061 [24]

Failure modes	Single anchor	Group of anchors	
		Most loaded anchor	Group
Steel failure	$\Delta V_{Ed} / \Delta V_{Rd,s,E,n} \leq 1.0$	$\Delta V_{Ed} / \psi_{FV} \cdot \Delta V_{Rd,s,E,n} \leq 1.0$	
Concrete pry-out failure	$\Delta V_{Ed} / \Delta V_{Rd,cp,E,n} \leq 1.0$		$\Delta V_{Ed} / \Delta V_{Rd,cp,E,n} \leq 1.0$
Concrete edge failure	$\frac{\Delta V_{Ed,c+}}{\Delta V_{Rd,c+,E,n}} + \frac{\Delta V_{Ed,c-}}{\Delta V_{Rd,c-,E,n}} + \frac{\Delta V_{Ed,cp}}{\Delta V_{Rd,cp,E,n}} \leq 1.0$		$\frac{\Delta V_{Ed,c+}}{\Delta V_{Rd,c+,E,n}} + \frac{\Delta V_{Ed,c-}}{\Delta V_{Rd,c-,E,n}} + \frac{\Delta V_{Ed,cp}}{\Delta V_{Rd,cp,E,n}} \leq 1.0$

Table 6.31: Failure modes and criteria against combined load in EOTA TR 061 [24]

Failure modes	Single anchor	Group of anchors	
		Most loaded anchor	Group
Steel failure		$\left( \frac{\Delta N_{Ed}}{\psi_{FN} \cdot \Delta N_{Rd,s,E,n}} \right)^{\alpha_{sn}} + \left( \frac{\Delta V_{Ed}}{\psi_{FV} \cdot \Delta V_{Rd,s,E,n}} \right)^{\alpha_{sn}} \leq 1$	
Concrete failure		$\frac{\Delta N_{Ed}}{\Delta N_{Rd,c(p,sp,cb),E,n}} \left( \frac{\Delta V_{Ed,cp}}{\Delta V_{Rd,cp,E,n}} + \frac{\Delta V_{Ed,c+}}{\Delta V_{Rd,c+,E,n}} + \frac{\Delta V_{Ed,c-}}{\Delta V_{Rd,c-,E,n}} \right)^{\alpha_c} \leq 1$	
Power factors in equations	$\alpha_S \leq 2.0$ and is considered from product relevant ETA. $\alpha_c = 1.5$ or can be taken from ETA		



**Note:** Design scope defined in EC2-4 [1]: 1) Verification against combined concrete cone and pull-out failure is not defined. 2) It does not consider pulsating or alternating shear loads separately for concrete failure check against combined loading. 3) Power factors used for verification against combined actions are not specified. 4) All other verifications are same as EOTA TR 061 [24].

$\Delta N_{Ek} = N_{Ek,max} - N_{Ek,min}$  and  $\Delta V_{Ek} = V_{Ek,max} - V_{Ek,min}$  are the peak-to-peak amplitude of the fatigue tensile and shear action for  $2 \times 10^6$  load cycles. It is the difference in maximum load and continuously acting load in tension and shear.  $N_{Rk,c}, N_{Rk,cb}, N_{Rk,sp}, V_{Rk,c}, V_{Rk,cp}$  are calculated using same formula as for static design (refer to Section 6.6).

The design verification includes the shear load distribution on fasteners for all possible angles with the edge as shown in Fig. 6.51.

$\Delta V_{Rd,c+,E,n}$ - determination with  $V_{Rk,c}$  using an angle  $0^\circ < \alpha_v < 90^\circ$

$\Delta V_{Rd,c-,E,n}$ - determination with  $V_{Rk,c}$  using an angle  $\alpha_v = 90^\circ$

$\Delta V_{Rd,cp,E,n}$ - determination with  $V_{Rk,cp}$

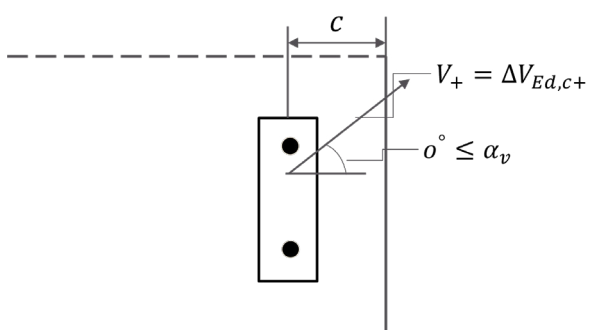

Pulsating shear load acting to the edge of concrete member

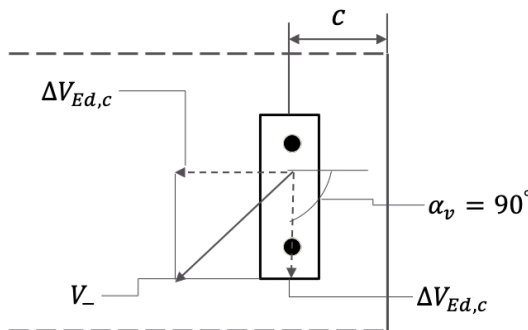

Pulsating shear load acting away from the edge of concrete member

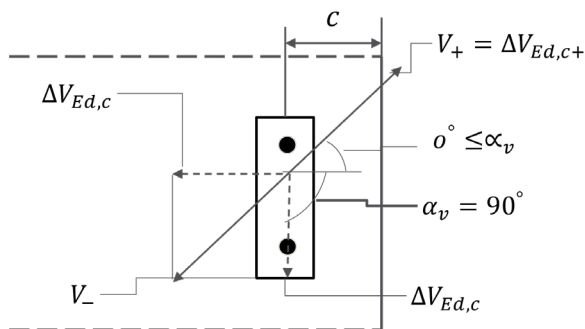

Alternating shear load acting to and away from the edge of concrete member

Fig. 6.51: Distribution of shear load acting on fasteners

### 6.12.2 Design methods according to EOTA TR 061

The partial factors for design fatigue load and resistance follow the same principle as stated in Section 6.6 and EC-0 [48]. However, EOTA TR 061 [24] includes additional provisions for the calculation of partial factors on acting loads.

$E_d = \gamma_{Fat} \cdot E_k$  where  $E_d$  is the design action,  $E_k$  is the characteristic action.

The partial safety factors for load and resistance against fatigue conditions are defined in EC2-4 [1] and EOTA TR 061 [24], shown in Table 6.33 and Table 6.32.

**Table 6.32: Partial safety factors for fatigue load**

Recommended value		Condition
$\gamma_{F,fat}$	1.0	When the value of design fatigue load is accurately determined from actual load combinations
	1.2	When the design fatigue load value is not confirmed, the load value is amplified for safe design, i.e., use of Miner's rule [49]

**Table 6.33: Partial safety factors for fatigue resistance**

Failure mode		Partial safety factor	Reference value
Tension	Steel	$\gamma_{Ms,N,fat}$	1.35 *)
	Concrete cone	$\gamma_{Mc,N,fat}$	$1.5 \cdot \gamma_{inst}$ ( $\gamma_{inst}$ is taken from ETA)
	Pull-out	$\gamma_{Mp,N,fat}$	$1.5 \cdot \gamma_{inst}$
Shear	Steel	$\gamma_{Ms,V,fat}$	1.35
	Concrete pry-out	$\gamma_{Mc,V,fat}$	$1.5 \cdot \gamma_{inst}$
	Concrete edge break-out	$\gamma_{Mp,V,fat}$	$1.5 \cdot \gamma_{inst}$

\*) In case of steel failure, at infinite number of load cycles ( $n = \infty$ ), i.e., at endurance limit  $\gamma_{Ms,N,fat} = 1.35$ . In between these two, transition zone, the  $\gamma_{Ms,N,fat}$  is calculated from the following equation.

$$\gamma_{Ms,fat,n} = \gamma_{M,fat} + (\gamma_{Ms} - \gamma_{M,fat}) \cdot (\Delta F_{Rk,n} - \Delta F_{Rk,\infty}) / (\Delta F_{Rk} - \Delta F_{Rk,\infty}) \text{ EOTA TR 061, sect. 2, eq. (3)}$$

The design of anchors is decided based on the fatigue influence. The fatigue influence or concept of fatigue resistance is defined in Table 6.34. There are two methods defined in EOTA TR 061 [24];

**Method I - Complete method** and **Method II - Simplified method** (Table 6.35).

**Note:** The applicable design method under fatigue loading depends on the type of assessment of the anchor used for the connection according to EAD 330250 [25]. See Table 6.35 and the following sections for more details.

Table 6.34: Fatigue influence on anchors (EOTA TR 061 [24], Table 2.1)

Step	Result	Note
<p><b>S-N curve for design fatigue resistance for lower fatigue load and n number of cycles</b>  <math>(\Delta F_{Rd,0,n}), F_{E lod} = 0</math></p>		<p>S-N curve provides the material fatigue strength at n load cycles and can be determined for each failure mode (Method -I). At a minimum, the fatigue limit resistance can be given at endurance level <math>\Delta F_{Rd,0,\infty}</math> (Method-II).</p>
<p><b>Fatigue resistance with lower cyclic load <math>F_{E lod}</math> and n load cycles, <math>\Delta F_{Rd,E,n}</math></b></p>		<p>The Goodman diagram determines the fatigue resistance <math>\Delta F_{Rd,E,n}</math> for different combinations of static and fatigue loading. The grey and red arrows correspond to static load and fatigue resistance in the case of alternating and pulsating fatigue loading.</p>
<p><b>Verification for ULS of fatigue resistance</b></p>		<p>Interaction diagrams are adopted with lower cyclic load, <math>F_{E lod}</math>.</p>

Table 6.35: Relation between Test method and Design method for fatigue cyclic loading

Assessment Method (EAD 330250 [25])			
Design Method	A - Continuous function of fatigue resistance depending on no of load cycles	B - Fatigue limit resistance	C - Collective actions are converted to one level with equivalent level of damage
Method I	X	Not applicable	X
Method II	X	X	X

### 6.12.2.1 Method I - Complete method

This method describes three different design cases for fatigue as explained in Table 6.36.

The following conditions are distinguished:

- a) Precise allocation of design lower cyclic load, alternation, pulsating load, or design upper negative cyclic load is possible (i.e., **static and fatigue load portions are known**) and/or
- b) upper limit of load cycles, **number of cycles**,  $n$ , in the working life is known.

Table 6.36: Conditions of applicability-Complete method

Design case	Condition	Condition for fatigue resistance	Fatigue resistance	Condition for fatigue cyclic load	Fatigue cyclic load
1	a)	Fatigue resistance ( $\Delta F_{Rd,E,n}$ ) corresponds to design limit fatigue resistance ( $\Delta F_{Rd,E,\infty}$ ) for pulsating/alternating load considering lower cyclic load	$\Delta F_{Rd,E,n}$ $= \Delta F_{Rd,E,\infty}$	Only design fatigue relevant load is considered	$\Delta F_{Ed}$ $= F_{Eupd} - F_{Elod}$
2	b)	Fatigue resistance corresponds to design fatigue resistance with a zero original load and $n$ load cycles	$\Delta F_{Rd,E,n}$ $= \Delta F_{Rd,0,n}$	$F_{Elod} > 0$ but the value is unknown	$\Delta F_{Ed} = F_{Eupd}$
				$F_{Eupd} < 0$ but the value is unknown	$\Delta F_{Ed} = -F_{Elod}$
				$F_{Elod} < 0$ and $F_{Eupd} > 0$ but the value is unknown	$\Delta F_{Ed}$ is known
3	Both a) and b)	Fatigue resistance corresponds to design fatigue resistance for pulsating / alternating load considering lower cyclic load and $n$ load cycles	$\Delta F_{Rd,E,n}$	Only design fatigue relevant load is considered	$\Delta F_{Ed}$ $= F_{Eupd} - F_{Elod}$

To consider the combination of static and fatigue cyclic loads, the influence of lower cyclic load on fatigue resistance can be determined using the **Goodman diagram**. This diagram can be plotted for the assumed numbers of cycles,  $n$ , or at endurance level (i.e.,  $\infty$  number of cycles). As shown in Fig. 6.52, it defines the fatigue resistance with respect to lower cyclic load for each failure mode. Method I (complete method) uses this diagram for different load cases as described in Table 6.36 to determine fatigue resistances, including all possible fatigue relevant load effects.

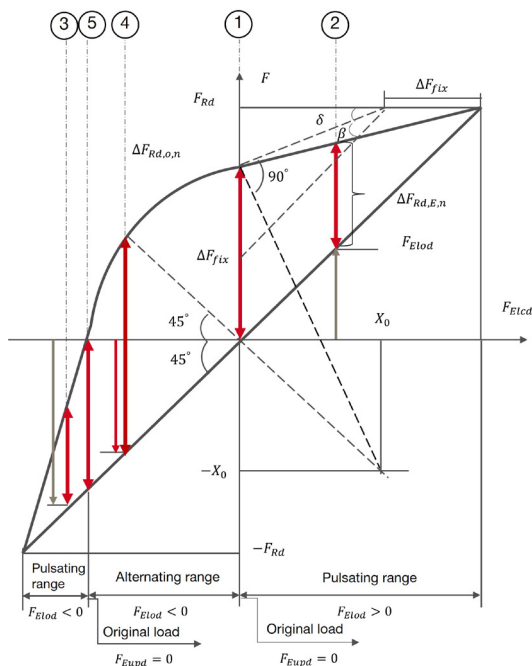

Fig. 6.52: Goodman diagram showing that fatigue resistance depends on lower cyclic load / static load

Cases 1) and 5) assume that the **entire load is fatigue relevant**, i.e.,  $F_{Elod} = 0$ . Its amplitude does not change sign, i.e., **pulsating action** in positive or negative direction, respectively.

Cases 2) and 3) imply the presence of a static load  $F_{Elod} > 0$  and its amplitude range is in positive or negative direction, respectively, i.e., **pulsating fatigue action**.

Position 4) defines the **fatigue load is alternating** including  $F_{Elod} < 0$ .

### 6.12.2.2 Method II - Simplified method

Precise allocation of  $F_{Elod}$  and the upper limit of load cycles,  $n$  in the working life cannot be predicted. It is a simple and conservative approach for fatigue design, i.e., **all loads are considered fatigue relevant**.

Since load cycles are unknown the fatigue resistance is determined for infinite load cycles ( $n = \infty$ ),  $\Delta F_{Rd,E,n} = \Delta F_{Rd,E,\infty}$ , Fatigue resistance is the design fatigue limit resistance where the original load,  $F_{Elod} = 0$ .

Design fatigue cyclic load follows the same criteria as given for design case 2 in Method I ([Section 6.12.2.1](#)).

### 6.12.3 Design example of post-installed anchors against fatigue loading

#### 6.12.3.1 Design example against high cycle fatigue load

Project requirement: A steel pipe is attached to concrete slab with steel baseplate. The connection is established using post-installed bonded anchors (Fig. 6.53).

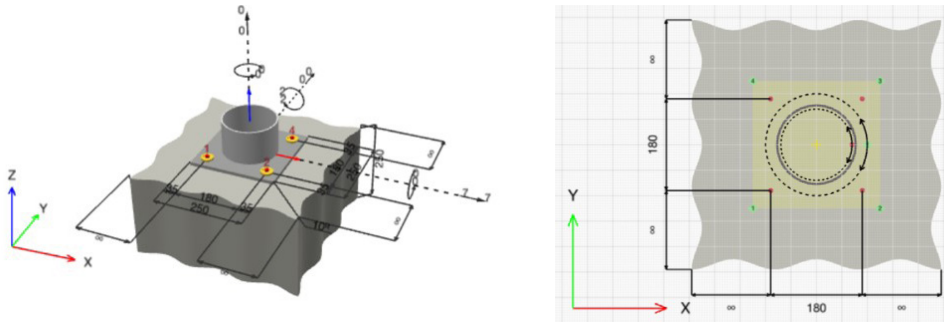

Fig. 6.53: Baseplate connection using post installed chemical anchors

Relevant project information:

Geometry of concrete:	Slab thickness, $h = 250 \text{ mm}$
Geometry of baseplate:	Plate dimension, $l \times w = 250 \times 250 \text{ mm}$ Plate thickness, $t = 20 \text{ mm}$
Materials:	Normal weight concrete C25/30, cracked Spacing of surface reinforcement of $100 \text{ mm}$ with $\varnothing 12$
Loading:	Moment, $M_{Ed} = 2 \text{ kNm}$ Shear, $V_{Ed} = 7 \text{ kN}$ (no stand-off)
Steel profile:	Pipe, L x W x T ( $159 \times 159 \times 4.5 \text{ mm}$ )
Design working life:	50 years
No of load cycles:	$\leq 1 \times 10^8$ (design method II for endurance level, and the entire load is considered as fatigue relevant.)

Details of post-installed anchors:

Type of anchor:	Chemical
No of anchor:	4
Spacing between anchors in X	$180 \text{ mm}$
Spacing between anchors in Y	$180 \text{ mm}$

Installation condition of post-installed anchors:

Drilling method/orientation:	Rotary-hammer drilling/horizontal, dry
System/solution choice:	Hilti HIT-HY 200 A-V3 + HAS-U A4(ETA-23/0277 [50]) with Hilti Filling Set

1) Analysis of tension and shear forces:

Moment acting on anchor group,  $\Delta M_{Ed} = 2 \text{ kNm}$ , will be divided in tension and compression among all anchors. The total tension force on anchor group is,  $\Delta N_{Ed} = 10.3 \text{ kN}$   
For this, neutral axis is calculated and force on each anchor is analyzed and the summary of both tension and shear load is shown in Fig. 6.54.

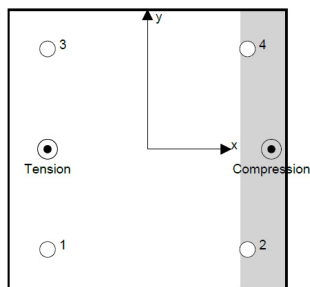

Anchor	Force [kN]	Type
1	5.2	Tension
3	5.2	Tension
1	1.75	Shear
2	1.75	Shear
3	1.75	Shear
4	1.75	Shear

Fig. 6.54: Force analysis of anchors

2) Details of proposed anchor: for fatigue condition the following anchor is used (Table 6.37).

Table 6.37: Properties of anchor

Type of anchor	Chemical	
Specification of anchor	HIT-HY 200 A-V3 + HAS-U A4	
Diameter of anchor	<i>d</i>	20 mm
Effective embedment depth	<i>h<sub>ef</sub></i>	125 mm



### DESIGN OF ANCHOR AND CHECK OF FAILURE MODES

Design verifications are carried out considering rigid baseplate as per EC2-4 [1], EOTA TR 061 [24] and characteristic resistances are taken from ETA-23/0277 [50]. For details on the calculations of resistances against the different failure modes please refer to [Section 6.12](#).

Check of tension load failures:

Steel failure:

The resistance against steel failure is calculated for the most stressed anchor using the following equation:

$$\frac{\Delta N_{Ed}}{\psi_{FN} \cdot \Delta N_{Rd,s,0,n}} \leq 1.0 \quad \text{EOTA TR 061, Table 2.2}$$

$$\Delta N_{Rd,s,0,n} = \frac{\Delta N_{Rk,s,0,n}}{\gamma_{M,s,N,fat}}$$

$$\Delta N_{Rk,s,0,n} = 20.1 \text{ kN} \quad \text{ETA-23/0277, Table C4}$$

$$\gamma_{M,s,N,fat} = 1.35 \quad \text{EOTA TR 061, sect. 2.1}$$

$$\Delta N_{Rd,s,0,n} = \frac{20.1}{1.35} = 14.9 \text{ kN}$$

$$\Delta N_{Ed} = 5.2 \text{ kN}$$

$$\psi_{FN} = 0.50 \quad \text{ETA-23/0277, Table C4}$$

$$\frac{\Delta N_{Ed}}{\psi_{FN} \cdot \Delta N_{Rd,s,0,n}} = \frac{5.2}{0.50 \cdot 14.9} = 0.70 \leq 1.0 \quad \text{verification fulfilled} \checkmark$$

Combined pull-out and concrete cone failure:

The resistance against combined pull-out and concrete cone failure is calculated for the group of anchors under tension loading using the following equation. For fatigue loading the following equations apply:

$$\frac{\Delta N_{Ed}^g}{\psi_{FN} \cdot \Delta N_{Rd,p,0,n}} \leq 1.0 \quad \text{EOTA TR 061, Table 2.2}$$

$$\Delta N_{Rd,p,0,n} = \frac{\Delta N_{Rk,p,0,n}}{\gamma_{M,p,N,fat}}$$

$$\Delta N_{Rk,p,0,n} = \eta_{k,p,N,fat,n} \cdot \Delta N_{Rk,p} \quad \text{ETA-23/0277, Table C4}$$

$$N_{Rk,p} = N_{Rk,p}^0 \cdot \frac{A_{p,N}}{A_{p,N}^0} \cdot \psi_{g,Np} \cdot \psi_{s,Np} \cdot \psi_{re,N} \cdot \psi_{ec,Np} \quad \text{EC2-4, eq. (7.13)}$$

$$\tau_{Rk,c} = 6.13 \text{ MPa} \quad \text{ETA-19/0601, Table C17}$$

$$\tau_{Rk,ucr} = 18 \text{ MPa for C20/25} \quad \text{ETA-19/0601, Table C1}$$

$$\tau_{Rk,cr} = 9.71 \text{ MPa for C20/25} \quad \text{ETA-19/0601, Table C1}$$

$$\psi_{sus} = 1.0 \text{ as } \psi_{sus}^0 = 0.8 \text{ and } \alpha_{sus} = 0 \quad \text{EC2-4, eq. (7.14a), ETA-19/0601, Table C1}$$

$$h_{ef,fat} = h_{ef} - \Delta h_{ef} = (125 - 25) = 100 \text{ mm} \quad \text{EOTA TR 061, eq. (4)}$$

$$s_{cr,Np} = 7.3d \cdot (\psi_{sus} \cdot \tau_{Rk})^{0.5} = 7.3 \cdot 20 \cdot (1.0 \cdot 6.13)^{0.5} = 495 > 3 \cdot 100 = 300 \text{ mm} \quad \text{EC2-4, eq. (7.15)}$$

$$c_{cr,Np} = s_{cr,Np} / 2 = (300/2) = 150 \text{ mm}$$

$$\psi_{g,Np}^0 = \sqrt{n} - \sqrt{(n-1)} \cdot \left( \frac{\tau_{Rk}}{\tau_{Rk,cr}} \right)^{1.5} = \sqrt{2} - \sqrt{(2-1)} \cdot \left( \frac{9.71}{18} \right)^{1.5} \geq 1, \psi_{g,Np}^0 = 1.0 \quad \text{EC2-4, eq. (7.18)}$$

$$\psi_{g,Np} = \psi_{g,Np}^0 - \left( \frac{s}{s_{cr,Np}} \right)^{0.5} \cdot (\psi_{g,Np}^0 - 1) = 1 - \left( \frac{180}{375} \right)^{0.5} \cdot (1 - 1) \geq 1, \psi_{g,Np} = 1.0 \quad \text{EC2-4, eq. (7.17)}$$

$$\text{Eccentricity } e_{c,N} = 0, \psi_{ec,Np} = 1.0 \quad \text{EC2-4, eq. (7.21)}$$

$$\psi_{s,Np} = 0.7 + 0.3 \cdot \left( \frac{c}{c_{cr,Np}} \right) = 0.7 + 0.3 \cdot \left( \frac{0}{172.5} \right) = 1.0 \quad \text{EC2-4, eq. (7.20)}$$

$$\psi_{re,N} = 1.0$$

$$A_{p,N}^0 = s_{cr,Np} \cdot s_{cr,Np} = 300 \cdot 300 = 90,000 \text{ mm}^2$$

$$A_{p,N} = (100 + 180 + 100) \cdot (100 + 180 + 100) = 144,400 \text{ mm}^2$$

$$N_{Rk,p}^0 = \psi_{sus} \cdot \tau_{Rk} \cdot \pi \cdot d \cdot h_{ef} = 1.0 \cdot 9.71 \cdot \pi \cdot 20 \cdot 100 = 61 \text{ kN} \quad \text{EC2-4, eq. (7.14)}$$

$$N_{Rk,p} = N_{Rk,p}^0 \cdot \frac{A_{p,N}}{A_{p,N}^0} \cdot \psi_{g,Np} \cdot \psi_{s,Np} \cdot \psi_{re,N} \cdot \psi_{ec,Np} = 61 \cdot \frac{144,400}{90,000} \cdot 1.0 \cdot 1.0 \cdot 1.0 \cdot 1.0 = 97.9 \text{ kN}$$

$$\Delta N_{Rk,p,0,n} = 0.40 \cdot 97.9 = 39.2 \text{ kN}$$

$$\eta_{k,p,fat,n} = 0.40 \quad \text{ETA-23/0277, Table C4}$$

$$\gamma_{M,p,N,fat} = 1.5 \quad \text{EOTA TR 061, Cl. 2.1}$$

$$\Delta N_{Rd,p,0,n} = \frac{39.2}{1.5} = 26.1 \text{ kN}$$

$$\Delta N_{Ed}^g = 10.3 \text{ kN}$$

$$\frac{\Delta N_{Ed}^g}{\Delta N_{Rd,p,0,n}} = \frac{10.3}{26.1} = 0.40 \leq 1.0 \quad \text{verification fulfilled } \checkmark$$

### Concrete cone failure:

The resistance against concrete cone failure is calculated for the group of anchors under tension loading using the following equation. For fatigue loading the following equations apply:

$$\frac{\Delta N_{Ed}^g}{\Delta N_{Rd,c,0,n}} \leq 1.0 \quad \text{EOTA TR 061, Table 2.2}$$

$$\Delta N_{Rd,c,0,n} = \frac{\Delta N_{Rk,c,0,n}}{\gamma_{M,c,N,fat}}$$

$$\Delta N_{Rk,c,0,n} = \eta_{k,c,N,fat,n} \cdot N_{Rk,c} \quad \text{ETA-23/0277, Table C4}$$

$$k_1 = 7.7, \quad \text{EC2-4, eq. (7.2)}$$

$$h_{ef} = 125 \text{ mm}$$

$$\Delta N_{Rk,c}^0 = k_1 \cdot \sqrt{f_{ck}} \cdot h_f^{1.5} = 7.7 \cdot \sqrt{25} \cdot 125^{1.5} = 53.8 \text{ kN}$$

$$A_{c,N}^0 = s_{cr,N} \cdot s_{cr,N} \text{ with } s_{cr,N} = 2 \cdot c_{cr,N} = 3 \cdot h_{ef} = 3 \cdot 125 = 375 \text{ mm and } c_{cr,N} = 187.5 \text{ mm}$$

$$A_{c,N}^0 = 375 \cdot 375 = 140,625 \text{ mm}^2$$

$$A_{c,N} = (187.5 + 187.5) \cdot (187.5 + 180 + 187.5) = 208,125 \text{ mm}^2 \quad \text{(Anchors 1 and 3 are in tension)}$$



$$\psi_{s,N} = 0.7 + 0.3 \cdot \frac{c}{c_{cr,N}} = 0.7 + 0.3 \cdot \frac{187.5}{187.5}, \psi_{s,N} = 1.0 \leq 1.0$$

$$\psi_{re,N} = 0.5 + \frac{h_{ef}}{200} \leq 1 = 0.5 + \frac{125}{200} = 1.125, \psi_{re,N} \leq 1.0, \text{ hence } \psi_{re,N} = 1.0$$

$$\text{Eccentricity } e_{N,1} = e_{N,2} = 0, \psi_{ec,N} = 1.0$$

$$\psi_{M,N} = 2 - \frac{z}{1.5 \cdot h_{ef}} = 2 - \frac{201.5}{1.5 \cdot 125} \geq 1.0, \psi_{M,N} = 0.93, \text{ hence } \psi_{M,N} = 1.0$$

$$z = 201.5 \text{ mm} \quad (\text{Refer to "cross section analysis" carried out e.g., with PROFIS Engineering})$$

$$\begin{aligned} \Delta N_{Rk,c} &= \Delta N_{Rk,c}^0 \cdot \frac{A_{c,N}}{A_{c,N}^0} \cdot \psi_{s,N} \cdot \psi_{re,N} \cdot \psi_{ec1,N} \cdot \psi_{ec2,N} \cdot \psi_{M,N} \\ &= 53.8 \cdot \frac{208,125}{140,625} \cdot 1.0 \cdot 1.0 \cdot 1.0 \cdot 1.0 \cdot 1.0 \end{aligned} \quad \text{EC2-4, eq. (7.1)}$$

$$\Delta N_{Rk,c} = 79.6 \text{ kN}$$

$$\eta_{k,c,N,fat,n} = 0.50 \quad \text{ETA-23/0277, Table C4}$$

$$\Delta N_{Rk,c,0,n} = 0.50 \cdot 79.6 = 39.8 \text{ kN}$$

$$\gamma_{M,c,N,fat} = 1.5 \quad \text{EOTA TR 061, Cl. 2.1}$$

$$\Delta N_{Rd,c,0,n} = \frac{39.8}{1.5} = 26.5 \text{ kN}$$

$$\Delta N_{Ed}^g = 10.3 \text{ kN}$$

$$\frac{\Delta N_{Ed}^g}{\Delta N_{Rd,c,0,n}} = \frac{10.3}{26.5} = 0.39 \leq 1$$

verification fulfilled ✓

#### Concrete splitting failure:

With reference to the criteria given in EC2-4 [1], sect. 7.2.1.7 (2) b) 2), the splitting failure is resisted by reinforcement in concrete with limitation in crack width of  $w_k \leq 0.3 \text{ mm}$ .

#### Check of shear load failures:

##### Steel failure:

The resistance against steel failure is calculated for the most stressed anchor using following equation:

$$\frac{\Delta V_{Ed}}{\psi_{FV} \cdot \Delta V_{Rd,s,0,n}} \leq 1 \quad \text{EOTA TR 061, Table 2.3}$$

$$\Delta V_{Rd,s,0,n} = \frac{\Delta V_{Rk,s,0,n}}{\gamma_{M,s,V,fat}}$$

$$\Delta V_{Rk,s,0,n} = 11.1 \text{ kN} \quad \text{ETA-23/0277, Table C5}$$

$$\gamma_{M,s,V,fat} = 1.35 \quad \text{EOTA TR 061, eq. (3)}$$

$$\Delta V_{Rd,s,0,n} = \frac{11.1}{1.35} = 8.2 \text{ kN}$$

$$\Delta V_{Ed} = 1.75 \text{ kN}$$

$$\psi_{FV} = 0.50 \quad \text{ETA-23/0277, Table C5}$$

$$\frac{\Delta V_{Ed}}{\psi_{FV} \cdot \Delta V_{Rd,s,0,n}} = \frac{1.75}{0.50 \cdot 8.2} = 0.43 \leq 1$$

verification fulfilled ✓

#### Concrete pry-out failure:

The resistance against concrete pry-out failure is calculated for the group of anchors. For fatigue loading the following equations apply:

$$\frac{\Delta V_{Ed,cp}}{\Delta V_{Rd,cp,0,n}} \leq 1 \quad \text{EOTA TR 061, Table 2.3}$$

$$\Delta V_{Rd,cp,0,n} = \frac{\Delta V_{Rk,cp,0,n}}{\gamma_{M,c,v,fat}}$$

$$\Delta V_{Rk,cp,0,n} = \eta_{k,c,v,fat,n} \cdot V_{Rk,cp} \quad \text{ETA-23/0277, Table C5}$$

$$V_{k,cp} = k_8 \cdot N_{Rk,c}$$

$$N_{Rk,c}^0 = 53.8 \text{ kN}$$

$$A_{c,N}^0 = s_{cr,N} \cdot s_{cr,N}$$

$$A_{c,N}^0 = 385 \cdot 385 = 140,625 \text{ mm}^2$$

$$A_{c,N} = (187.5 + 180 + 187.5) \cdot (187.5 + 180 + 187.5) = 308,025 \text{ mm}^2$$

$$\psi_{s,N} = 1.0, \psi_{re,N} = 1.0, \psi_{ec,N} = 1.0, \psi_{M,N} = 1.0$$

$$N_{Rk,c} = 53.8 \cdot \frac{308,025}{140,625} \cdot 1.0 \cdot 1.0 \cdot 1.0 \cdot 1.0 \cdot 1.0 = 117.9 \text{ kN}$$

$$k_8 = 2$$

$$V_{Rk,cp} = 2 \cdot 117.9 = 235.7 \text{ kN}$$

$$\eta_{k,c,v,fat,n} = 0.50 \quad \text{ETA-23/0277, Table C5}$$

$$\Delta V_{Rk,cp,0,n} = 0.50 \cdot 235.7 = 117.9 \text{ kN}$$

$$\gamma_{M,c,v,fat} = 1.5 \quad \text{EOTA TR 061, Cl. 2.1}$$

$$\Delta V_{Rd,cp,0,n} = \frac{117.9}{1.5} = 78.6 \text{ kN}$$

$$\Delta V_{Ed,cp} = 7 \text{ kN}$$

$$\frac{\Delta V_{Ed,cp}}{\Delta V_{Rd,cp,0,n}} = \frac{7}{78.6} = 0.09 \leq 1.0 \quad \text{verification fulfilled } \checkmark$$

Check for combined tension and shear load:

Steel failure: EC2-4, Annex D, sect. D.4.4

Ratio between action load and resistance in tension,  $\beta_N = 0.70 \leq 1.0$

Ratio between action load and resistance in shear,  $\beta_V = 0.43 \leq 1.0$

$$\beta_N^\alpha + \beta_V^\alpha = 0.70^{0.7} + 0.43^{0.7} = 1.33.$$

ETA-23/0277, Table C6

$$\beta_N^\alpha + \beta_V^\alpha \geq 1$$

verification not fulfilled  $\times$

Failure other than steel:

EC2-4, Annex D, sect. D.4.4

Ratio between action load and resistance in tension,  $\beta_N = 0.40 \leq 1.0$

Ratio between action load and resistance in shear,  $\beta_V = 0.09 \leq 1.0$

$$\beta_N^\alpha + \beta_V^\alpha = 0.40^{1.5} + 0.09^{1.5} = 0.28.$$

ETA-23/0277, Table C6

$$\beta_N^\alpha + \beta_V^\alpha \leq 1$$

verification fulfilled  $\checkmark$

### 6.12.3.2 Design example against lower cycle fatigue load

Project requirement is same as mentioned in previous section except the fatigue load cycles. Here, the number of fatigue load cycles considered as  $1 \times 10^6$  and design has been checked according to method-I (Complete method) as per EOTA TR 061 [24].

Design verifications are carried out considering rigid baseplate as per EC2-4 [1], EOTA TR 061 [24] and characteristic resistances are taken from ETA-23/0277 [50]. For a details on the calculations of resistances against the different failure modes please refer to [Section 6.12](#).

Check of tension load failures:

Steel failure:

The resistance against steel failure is calculated for the most stressed anchor using the following equation:

$$\frac{\Delta N_{Ed}}{\psi_{FN} \cdot \Delta N_{Rd,s,0,n}} \leq 1$$

$$\Delta N_{Rd,s,0,n} = \frac{\Delta N_{Rk,s,0,n}}{\gamma_{M,s,N,fat}}$$

$$\Delta N_{Rk,s,0,n} = 31.4 \text{ kN}$$

$$\gamma_{M,s,N,fat} = 1.39$$

$$\Delta N_{Rd,s,0,n} = \frac{31.4}{1.39} = 22.6 \text{ kN}$$

$$\Delta N_{Ed} = 5.2 \text{ kN}$$

$$\psi_{FN} = 0.5$$

$$\frac{\Delta N_{Ed}}{\psi_{FN} \cdot \Delta N_{Rd,s,0,n}} = \frac{5.2}{0.5 \cdot 22.6} = 0.46 \leq 1$$

EOTA TR 061, Table 2.2

ETA-23/0277, Table C1

EOTA TR 061, sect. 2.1

ETA-23/0277, Table C1

verification fulfilled ✓

**Note:** In comparison to the previous example, the steel tensile resistance has increased, due to the lower number of expected loading cycles.

Combined pull-out and concrete cone failure:

The resistance against combined pull-out failure and concrete cone failure calculated in the previous example is still valid.

Concrete cone failure:

The resistance against concrete cone failure calculated in the previous example is still valid.

Check of shear load failures:

Steel failure:

The resistance against steel failure is calculated for the most stressed anchor using following equation:

$$\frac{\Delta V_{Ed}}{\psi_{FV} \cdot \Delta V_{Rd,s,0,n}} \leq 1$$

$$\Delta V_{Rd,s,0,n} = \frac{\Delta V_{Rk,s,0,n}}{\gamma_{M,s,V,fat}}$$

$$\Delta V_{Rk,s,0,n} = 17.1 \text{ kN}$$

$$\gamma_{M,s,V,fat} = 1.367$$

$$\Delta V_{Rd,s,0,n} = \frac{17.1}{1.367} = 12.5 \text{ kN}$$

$$\Delta V_{Ed} = 1.75 \text{ kN}$$

$$\psi_{FV} = 0.50$$

$$\frac{\Delta V_{Ed}}{\psi_{FV} \cdot \Delta V_{Rd,s,0,n}} = \frac{1.75}{0.50 \cdot 12.5} = 0.29 \leq 1$$

EOTA TR 061, Table 2.3

ETA-23/0277, Table C2

EOTA TR 061, eq. (3)

ETA-23/0277, Table C5

verification fulfilled ✓

**Note:** In comparison to the previous example, the steel shear resistance has increased, due to the lower number of expected loading cycles.

Concrete pry-out failure:

The resistance against concrete pry-out failure calculated in the previous example is still valid.

**Note:** The design has been satisfied for lower cycle fatigue load using same anchors. It can be concluded that in practical situations, the assessment of expected numbers of fatigue load cycles (in this case  $1 \times 10^6$ ) may be useful to reach a more optimized design according to method-I of EOTA TR 061 [24].

## 6.13 Design of post-installed fastenings-EC2-4 (simplified methods)

EC2-4 [1] Annex G defines three methods for design of post-installed anchors in ultimate limit state and it is described in Fig. 6.55.

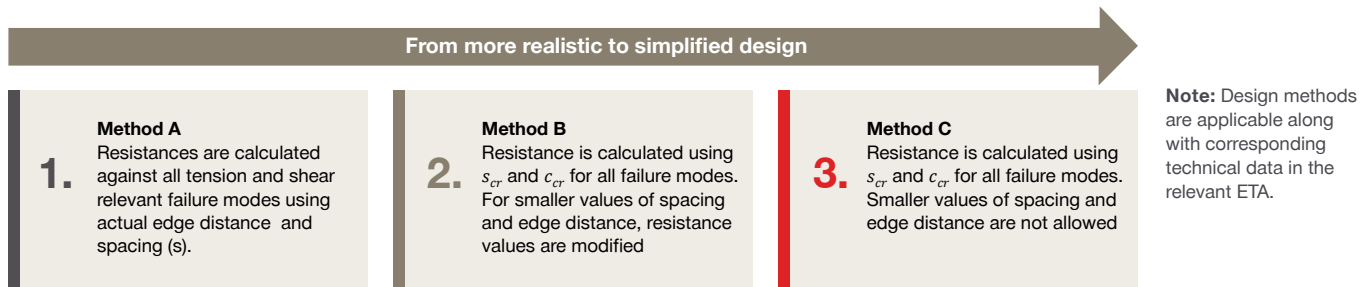

Fig. 6.55: Design methods in EC2-4

### 6.13.1 Design according to Method A

Design Method A includes the design verification against all relevant failure modes for tension and shear loading as explained in earlier sections of this chapter.

### 6.13.2 Design according to Method B

This method uses single value of characteristic resistance,  $F_{Rk}^0$  and design resistance  $F_{Rd} = F_{Rd}^0$  is calculated using the equation:

$$F_{Rd}^0 = F_{Rk}^0 / \gamma_m \quad \text{EC2-4, eq. (G.1)}$$

When spacing and edge distance are smaller than critical values, the effect of influencing factors are taken into consideration.

Geometric influence factor -  $A_c/A_c^0$  and  $\psi_s$

Factor to include effect of closely spaced reinforcement -  $\psi_{Re}$  and influence of concrete compressive strength-  $\psi_c$ .

The modified design resistance with number of loaded anchors,  $n$  is calculated using following expression:

$$F_{Rd} = \frac{1}{n} \cdot \frac{A_c}{A_c^0} \cdot \psi_s \cdot \psi_{Re} \cdot \psi_c \cdot F_{Rd}^0 \quad \text{EC2-4, eq. (G.2)}$$

Shear resistance of anchor,  $V_{Rks} / \gamma_M$  is limited to the value of  $F_{Rd}$ .

**Note:** The design method B is very similar to the former "Kappa-method".

**Note:** For bonded fasteners, this equation is multiplied by sustained load factor  $\psi_{sus}$ .

### 6.13.3 Design according to Method C

This method does not include edge distance and spacing smaller than critical values. All other design criteria are the same as Method-B defined in [Section 6.13.2](#).

## 6.14 Design of redundant non-structural fastening as per EC2-4 and CEN/TR 17079

Depending on the structure-specific safety requirements, a fastening system is formed so that the loads are transferred into the base material either via individual anchors, which can also be formed as a group of fasteners, or with a **multiple-fastener system in a redundant arrangement**. Single fastening involves a fastener to secure an element in place, while redundant fastening involves additional fasteners to enhance stability and safety. **If one anchor fails** or exhibits excessive displacement, the redundant non-structural system relies on having a **fixture that can redistribute the load** of the insufficiently behaving anchor **to the neighboring anchors**.

EC2-4 [1] includes a scope of design for post-installed fastenings, including statically determinate and indeterminate structural and non-structural connections. CEN/TR 17079 [51] defines a detailed scope for post-installed anchors to fix statically indeterminate non-structural lightweight systems for the following conditions:

- One or more anchors can be placed at each fixing point and elements to be connected using a **minimum of three fixing points**.
- When more than one anchor is used at a fixing point, all the **fasteners must be of the same type, size, and length**.
- Considering redundant systems, **fixture must be rigid** enough to transfer the loads to the adjacent fasteners without any effect on performance at SLS and ULS condition as desired.

**Note:** The non-structural light weight elements include piping, light suspended ceiling, façade etc.

The other relevant details: type of anchors, dimension and materials, fastener loading, concrete strength, concrete dimensions etc. are given in the CEN/TR 17079 [51].

The design verification includes the scope of design load limited to the values of 2.0 kN and 3.0 kN for a minimum of 3 and 4 fixing points, respectively (see CEN/TR 17079 [51], Table 4.1). Hence, verification of fixing points after redistribution of loads is not required. Within the limiting design load, fasteners are designed according to EC2-4 [1], Annex G (Methods A and B) provisions as discussed in previous sections.

## 6.15 Verification of concrete elements due to loads applied by fastenings

Post-installed anchors transfer the design loads from the steel profile with baseplate to concrete member. It is important to verify whether the concrete element is capable of handling the loads transferred by anchors following the principles of EC2-1-1 [27]. EC2-4 [1] Annex A includes the scope for verification against shear loading of the concrete member. The same is described in Fig. 6.56.

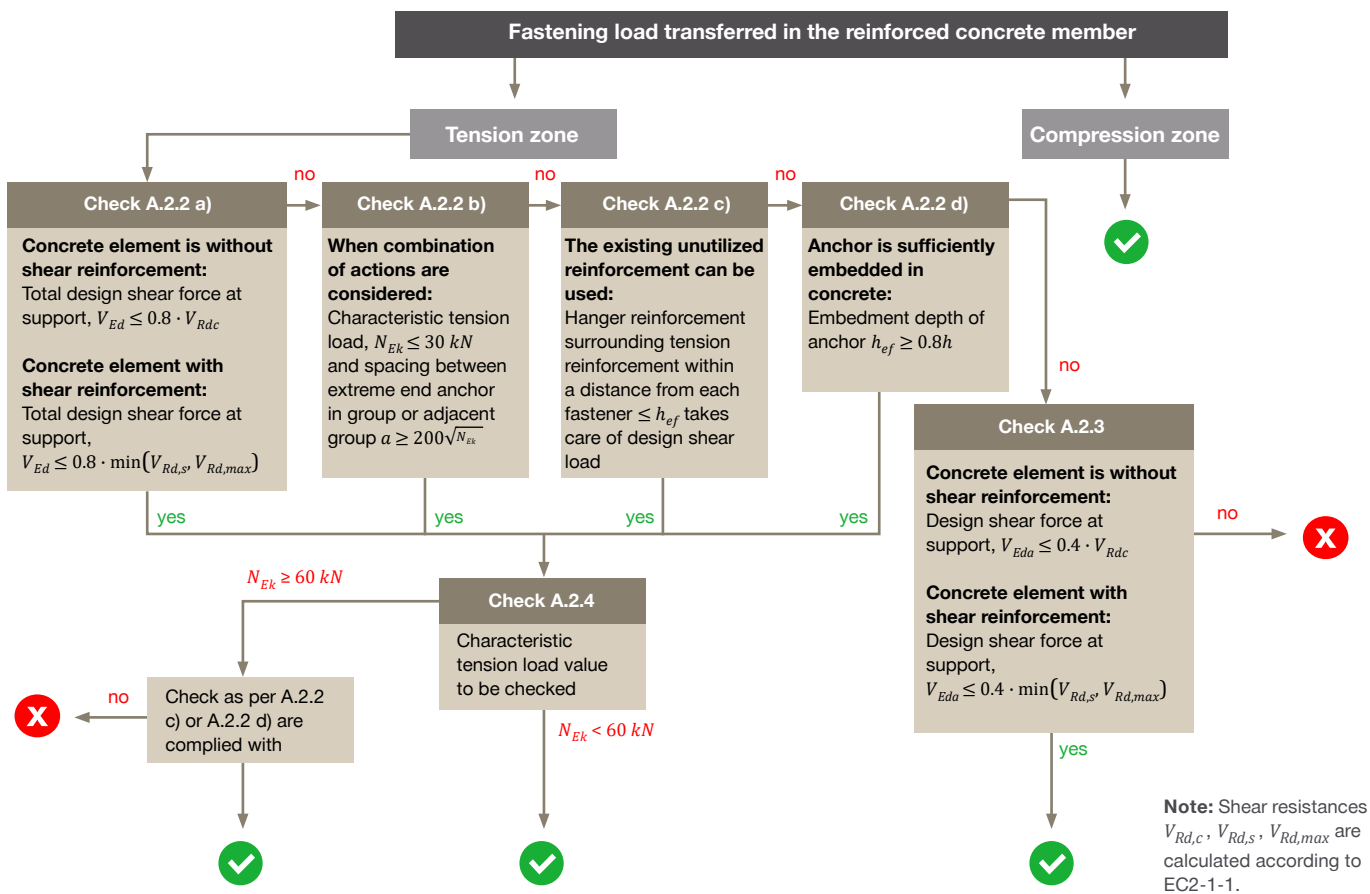

- ✓ The reinforced concrete member is verified for the forces introduced by the fastening
- ✗ The reinforced concrete member is NOT verified for the forces introduced by the fastening

Fig. 6.56: Design verification of concrete member as per EC2-4 [1] Annex A

## 7. PROFIS ENGINEERING SUITE – SOFTWARE DESIGN

### 7.1 Introduction

Post-installed anchors can be designed manually, but getting an optimized solution may be very time consuming. In such cases, a design software becomes necessary and allows designers to get the most optimized solution within very short time, avoiding reworking and manual errors. **PROFIS Engineering** is user-friendly, cloud-based structural engineering design software that solves these issues. It includes modules for various construction applications including **steel-to-concrete**, **concrete-to-concrete** and **steel-to-masonry** connections. The software provides engineers with tools to analyze and optimize fastening designs, calculate resistances of fastenings under different loading and boundary conditions, and generate detailed design reports. The various design methods and loading conditions (static, seismic, fire and fatigue) discussed in previous chapters are covered. By using PROFIS Engineering, the design process can be streamlined and accuracy can be enhanced. Finally, overall efficiency can be improved while creating safer and more reliable post-installed fastening solutions for construction projects. The software helps to ensure that the specified post-installed fastening systems meet the applicable standards and regulations, providing confidence in the structural integrity and safety of connections.

PROFIS Engineering also includes features for visualizing and communicating a design, such as the 3D display of forces and structural components and 2D cross-section drawings that show the required detailing and design reports with detailed calculations. The efficiency of the solution (i.e., utilization ratio) can be shown instantly.

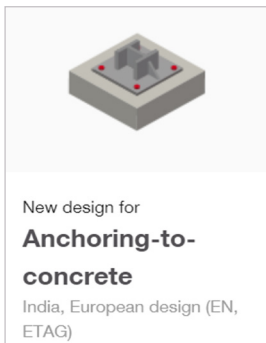

**PROFIS Engineering** interface for design of an S2C connection

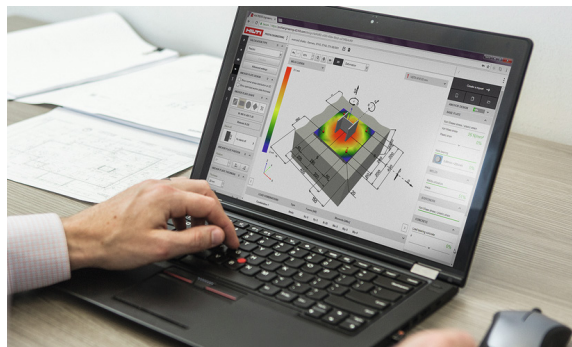

**PROFIS interface** - Example of S2C applications

**Fig. 7.1: PROFIS Engineering suite modules for design of S2C connections**

### 7.2 Why use PROFIS Engineering Suite?

PROFIS Engineering offers several advantages that make it a preferred choice for professionals in the industry. It offers a complete solution for S2C baseplate and anchorage applications from defining a model to creating designs and outputs. All applications discussed in [Chapter 2](#) of this handbook can be designed using PROFIS in a very efficient, quick, accurate and transparent way. Comprehensive structural analysis is done considering all design methods such as EC2-4 [1], EOTA TR 061 [24], EOTA TR 082 [46], etc. Manual calculations giving different possible solutions can be compared with the results from the software, thanks to the comprehensive design report that is generated as design output. This allows you to find the most optimized and relevant solution. Key features of PROFIS Engineering are summarized in Fig. 7.2.

<p><b>Comprehensive structural analysis of post-installed anchors, baseplate</b></p> <ul style="list-style-type: none"> <li>• Easy modelling of the connection</li> <li>• Calculates and generates reports for the complete connection</li> <li>• Provides an wide range of analysis</li> </ul>	<p><b>User-friendly interface -online collaboration between multiple users</b></p> <ul style="list-style-type: none"> <li>• Simplifies the modeling and analysis</li> <li>• Provides a graphical representation of the structure, making it easier for engineers to visualize and modify the design as needed</li> </ul>	<p><b>Extensive design codes complying with local regulations</b></p> <ul style="list-style-type: none"> <li>• Incorporates a comprehensive set of design codes and standards from various countries and organizations</li> <li>• Code compliant design</li> </ul>	<p><b>Advanced analysis capabilities, one-stop solution</b></p> <ul style="list-style-type: none"> <li>• Employs advanced analysis techniques such as component based finite element analysis (CBFEM) and nonlinear analysis to accurately simulate the behavior of complex structural systems</li> </ul>
	<p><b>Integration with other Software CAD, STAADPro, ETABS, SAP</b></p> <ul style="list-style-type: none"> <li>• Enables engineers to import structural models and synchronize changes between the two platforms</li> <li>• Improves workflow efficiency, enhances collaboration</li> </ul>	<p><b>Reliable support team and continuous updates</b></p> <ul style="list-style-type: none"> <li>• Address any software-related issues that may arise</li> <li>• Updates to incorporate new features, and enhancements</li> </ul>	<p><b>Cost and time savings, easy handling of revisions</b></p> <ul style="list-style-type: none"> <li>• Optimizes structural designs, saves cost in materials and construction</li> <li>• Reduces the time required to develop and validate structural models</li> </ul>

Fig. 7.2: PROFIS as the first design software for complete S2C baseplate and anchorage applications

### 7.3 Design of post-installed anchors for S2C applications in PROFIS

In this chapter, the flow of design and final output of post-installed anchors and baseplate are presented.

#### 7.3.1 Concrete properties and installation conditions

Concrete properties can be selected from the list available in PROFIS. A range of concrete grades is available from C12/15 to C50/60. Geometry of the base material is selected by changing the length, width, and thickness values (Fig. 7.3). Also, the edges are defined by selecting the option for “infinity” or providing any specific value in both X and Y directions. These values can be changed by clicking on the geometry itself.

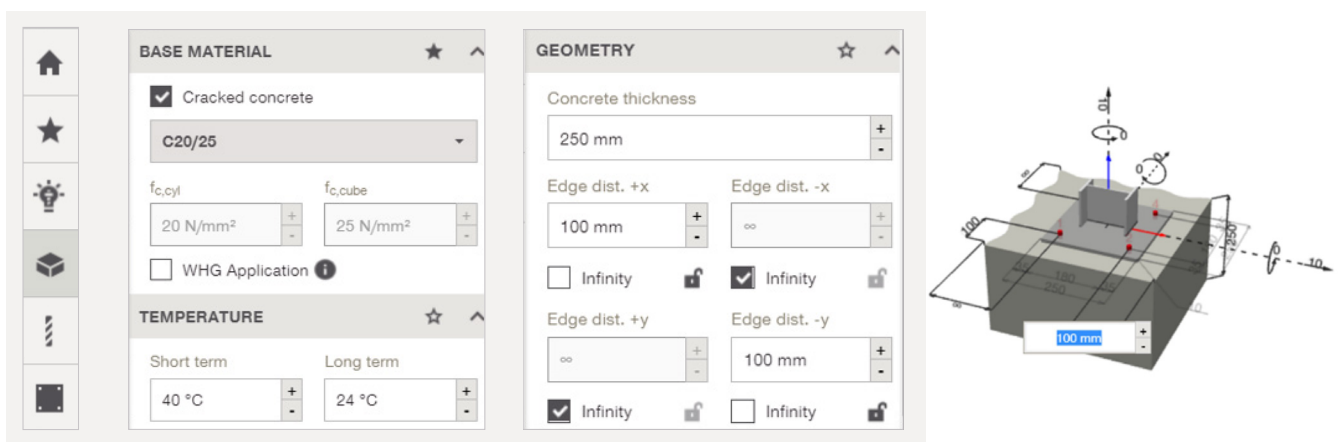

Fig. 7.3: Selection of base material (concrete) and defining properties in PROFIS



Installation conditions involve the selection of the temperature during installation/injection of an adhesive mortar (see Table 5.2). The drilling method, condition of drilled holes (e.g., dry/wet/water filled), and torquing method (discussed in [Chapter 8](#)) can also be defined. This part of the design procedure affects the selection of a qualified ETA product for design as well as installation parameters. The PROFIS Engineering interface is shown in Fig. 7.4.

**Note:** PROFIS allows entering custom values of concrete material grades (e.g., concrete strength classes higher than C50/60), when technical data are available for a specific product.

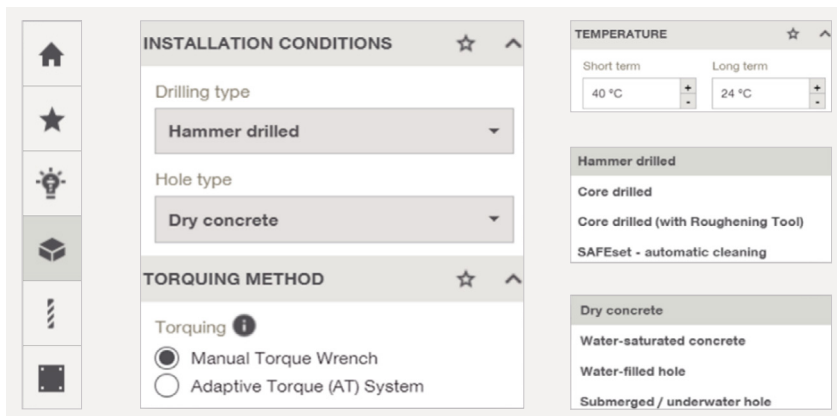

Fig. 7.4: Defining installation condition in PROFIS

### 7.3.2 Concrete reinforcement and supplementary reinforcement

PROFIS helps the designer to consider the effect of the reinforcement if present in the concrete member, as per EC2-4 [1] provisions (Fig. 7.5). Different detailing of reinforcement can be modelled and the influence on different failure modes is taken into account. The effect of supplementary reinforcement as described in [Section 6.7](#) can be considered to achieve optimized design solutions.

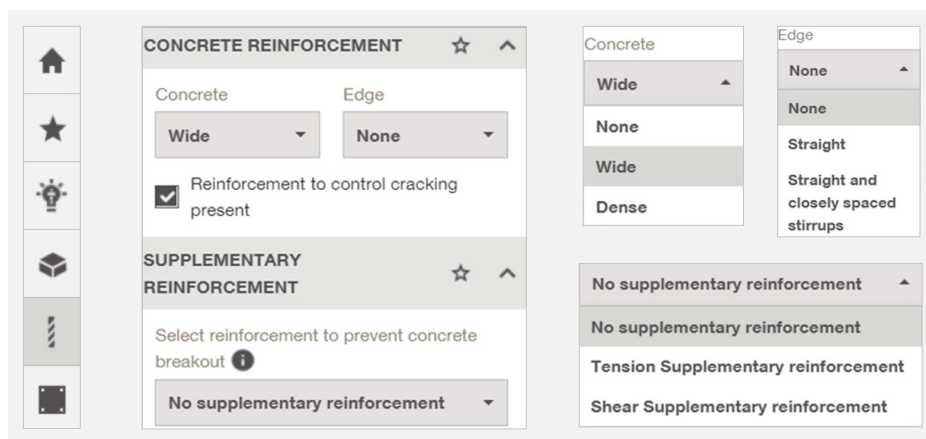
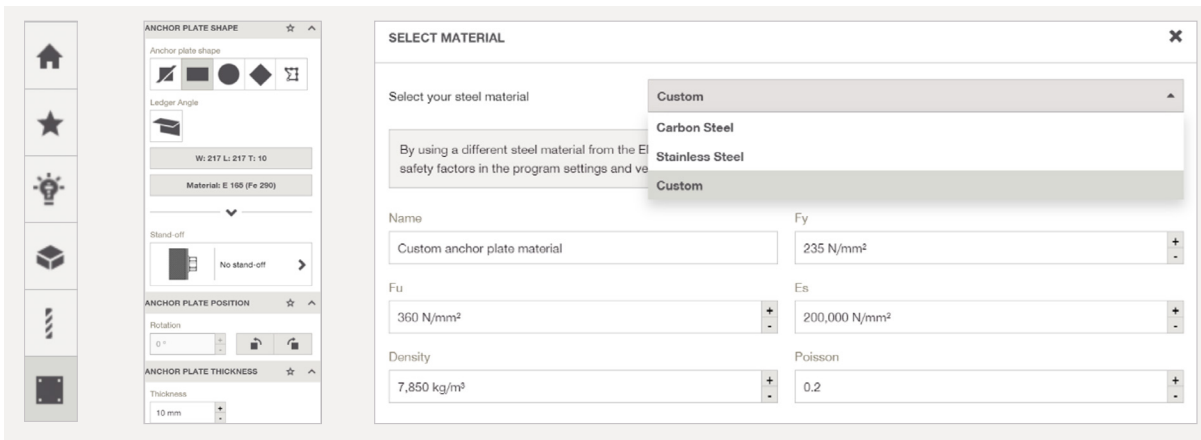

Fig. 7.5: Reinforcement properties selection in PROFIS

### 7.3.3 Baseplate type selection

Steel baseplate can be defined by choosing the shape (rectangular, square, circular, trapezoidal etc.) and material grade. The material grade can be selected from a list available from guidelines, or local steel material or can be customized as per the user's choice. In case of "custom" grade, yield stress, ultimate

tensile strength, elastic modulus, density, and Poisson's ratio have to be defined. Dimensions of anchor plates need to be defined providing values of length, width, and thickness. The position of an anchor plate can be decided using the rotation parameter and the condition of stand-off can be selected from the options in PROFIS (Fig. 7.6).



**Fig. 7.6: Anchor plate definition in PROFIS**

### 7.3.4 Steel profile selection

The steel profile which is connected to the anchor plate is defined using the profiles as per various national standards available in PROFIS. Material grade for steel is defined as discussed in the previous section for selection of baseplate. In addition, stiffeners can be defined. The position of the profile is defined using the eccentricity values in X and Y directions (Fig. 7.7).

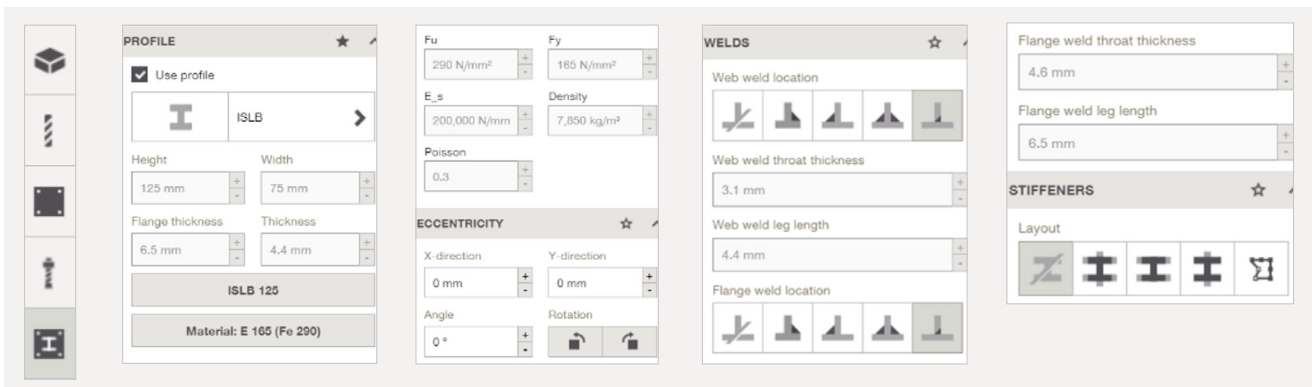

**Fig. 7.7: Definition of steel profiles and stiffeners in PROFIS**

### 7.3.5 Calculation types available in PROFIS: stiff vs. flexible baseplate

As default, the design of post-installed anchors is carried out according to EC2-4 [1] considering **baseplate as rigid** (refer to [Section 6.1](#)). Though the anchor plate is considered as rigid plate as an ideal condition with no deformation, **in real situations a plate with zero deformation is not possible**. PROFIS helps you in assessing, how the assumption of rigid baseplate is far away from the reality. An example is shown in Fig. 7.8 with the difference in force of anchors with the consideration of baseplate as both rigid and flexible.

A connection has been selected with the tension force applied as 10 kN and a shear force of 10 kN in X direction. Baseplate thickness is 20 mm and a group of 4 anchors is considered.

The maximum deformation of a flexible connection is 0.1 mm and for this small deformation the force on anchors increases up to 48% which may be a concern for the designer. Real-time finite element analysis is required to get the actual forces on anchors and the design of baseplate. Sometimes, the flexibility of a baseplate can have impact on the serviceability of the connection and, to solve this problem, PROFIS helps by the **component-based finite element method** or **CBFEM** analysis and provides numerical and graphical non-linear results. More details are available in [52] and [53].

	Equivalent rigid anchor plate (CBFEM)	Component-based Finite Element Method (CBFEM) anchor plate
<b>Anchor tension forces</b>		
Anchor 1	2.5 kN	3.7 kN (48%)
Anchor 2	2.5 kN	3.7 kN (48%)
Anchor 3	2.5 kN	3.7 kN (48%)
Anchor 4	2.5 kN	3.7 kN (48%)

Fig. 7.8: Tension force of anchors (rigid and flexible baseplate)

CBFEM defines flexible design of baseplate and deformation and stress values can be checked using this analysis (refer to [Section 6.3](#)). CBFEM is a synergy of the Component method and Finite element analysis [54]. It performs detailed and accurate analysis of elements, considering factors such as cracking, nonlinearity and load redistribution. There is an option of “Advanced settings” where the mesh details (number of elements, maximum size of element, number of iterations) and results (ULS stress, strain etc.) can be decided by the user. Since CBFEM splits the component into separate elements, it is possible to deliver Finite element analysis-oriented code compliant results and to simulate real-time structural behavior. Steel plate is meshed as shell elements, anchors are modelled as non-linear tension springs and their stiffness is taken from Hilti technical data. Concrete is modelled as compression spring. The contribution of welded stiffeners can be taken into account enabling stress distribution in a more accurate way (Fig. 7.9 and Fig. 7.10). Girme et. al. [54] has done extensive research with Hilti bonded anchors designed in PROFIS to analyze the result for rigid and CBFEM methods.

**Note:** CBFEM can handle any combination of loading and profile eccentricity, unlike the rigid system.

**Note:** There is no unique definition of the rigid system. It depends on how much deformation is allowed for the connection.

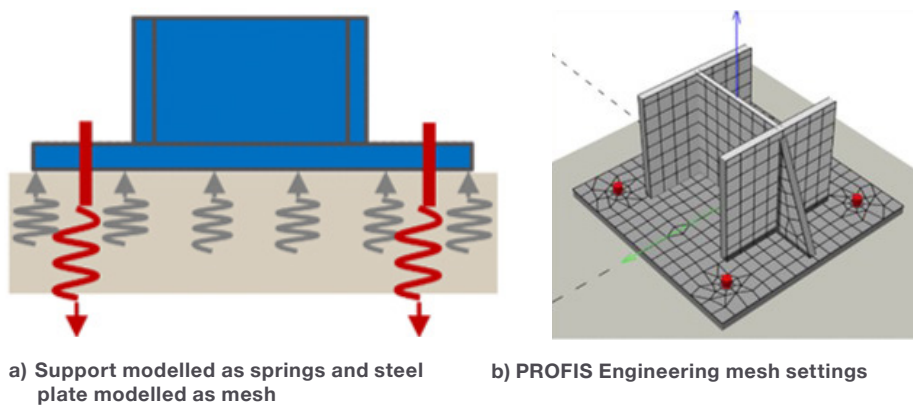
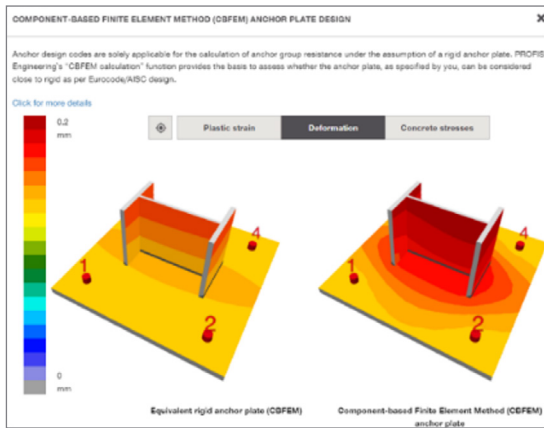
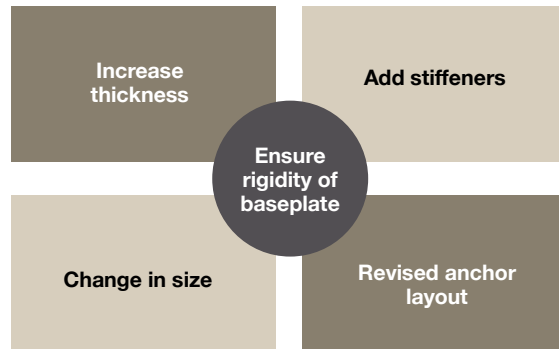

Fig. 7.9: CBFEM input and modelling



a) CBFEM analysis results from PROFIS



b) Steps that can be taken to ensure rigidity

Fig. 7.10: PROFIS helps make detail calculations for CBFEM

### 7.3.6 PROFIS helps to choose the suitable anchor for specific applications

Designer can choose some typical anchor solutions in PROFIS by selecting some major parameters. “Application type”, “loading condition”, “installation condition” all play a major role in the selection of the most appropriate anchor system. Fig. 7.11 shows how PROFIS can help the designer in choosing among typical anchor types for specific applications. Additionally, PROFIS offers a filter function to select anchor types by fixture thickness, hole diameter, corrosion resistance, drilling and cleaning method, etc.

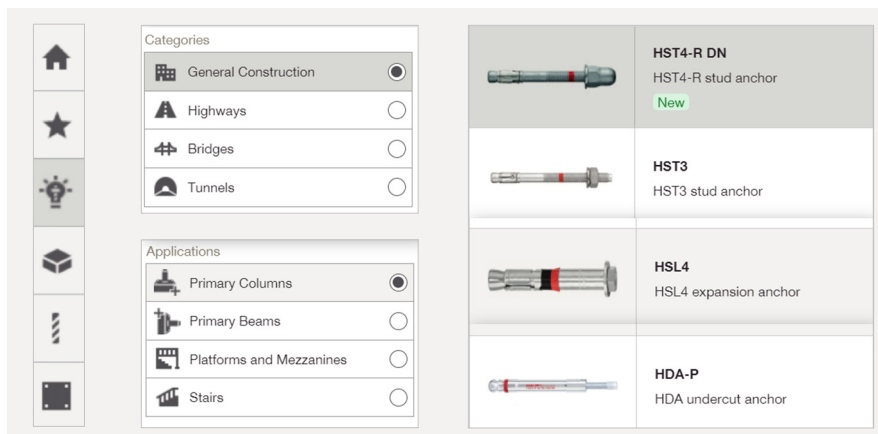

Fig. 7.11: Selection of anchors - primary areas to focus in PROFIS

The anchor selection includes the choice of diameter and embedment depth. The layout of anchors in a group can be defined using standard configurations in PROFIS (see Fig. 7.12) or with customized layouts of up to 99 anchors. The user can define if the holes are circular or slotted and whether the annular gap is filled or not.

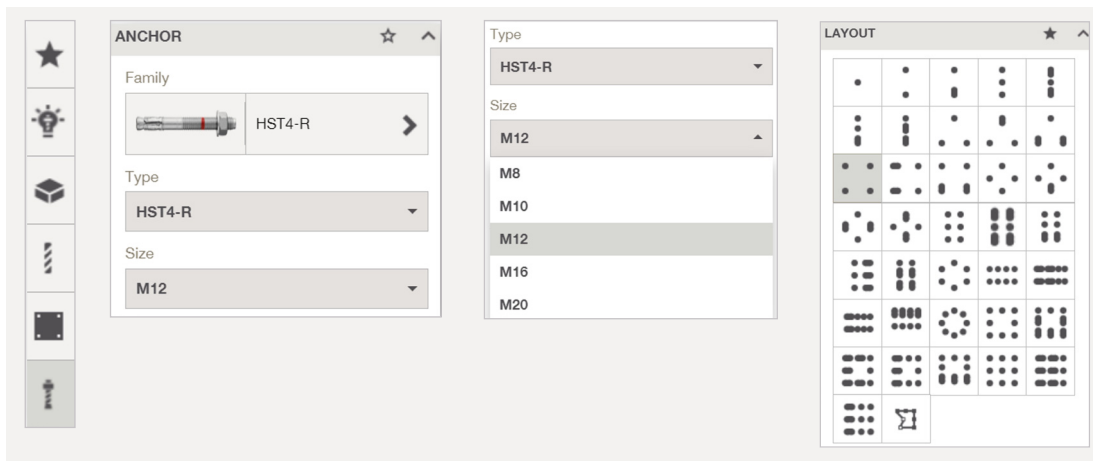

Fig. 7.12: Type of anchor and anchor properties, layout in PROFIS

**Note:** PROFIS includes all updated technical data from the relevant ETAs or that issued by Hilti. The user can download the ETA for reference.

### 7.3.7 Loading types in PROFIS

This section introduces the inputs for load types, load values, design standards and guidelines to proceed with a design and to run analysis. The load type (Fig. 7.13) can be selected as Static / Seismic / Fire / Fatigue (see Sections 6.6, 6.10, 6.11, 6.12). Tension and/or shear load and moment values can be imported from an existing file, from other integrated software, or inserted by user. The load values given as input are factored. The design standard is selected from the drop-down menu: EC2-4 [1], EOTA TR 061 [24], EOTA TR 082 [46], the HILTI Method (SOFA) or other local standards (refer to Section 6.5). All the load values can also be entered in the defined spaces in the 3D editor itself. Multiple loading combinations can be checked by PROFIS simultaneously.

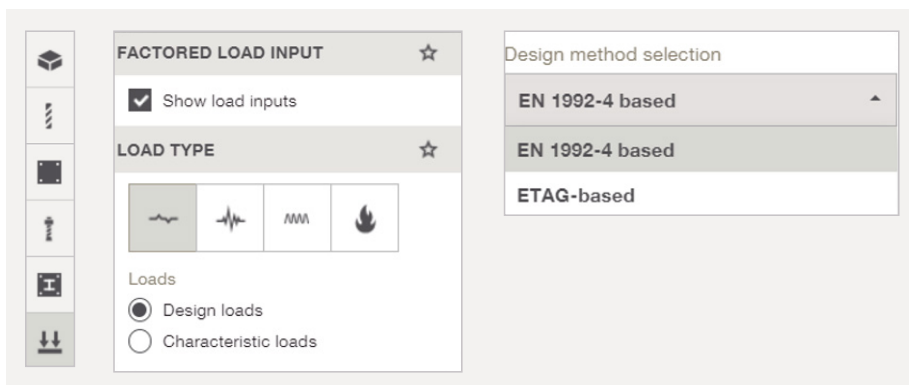

Fig. 7.13: Selection of loading condition in PROFIS

### 7.3.8 Design output, reports and drawings

Once the user has found the preferred design solution, a comprehensive report can be generated at a click of a button. This design output report shows all the input data (geometry, material, loads, etc.), load on each anchor (tension/compression) and detailed calculations for all the design checks. The report also shows 3D and 2D sectional drawings with embedment depths that can be used for design specifications. Additionally, warnings and guidelines for installation are also provided in the report. PROFIS gives you option to see the results even without report generation, providing a “utilization percent” for each failure mode at the right side of the user interface (Fig. 7.14).

**Note:** All design examples included in this handbook can be reproduced in PROFIS.

Anchor	N [kN]	Vx [kN]	Vy [kN]
1	2.5	1.25	0
2	2.5	1.25	0
3	2.5	1.25	0
4	2.5	1.25	0

Fig. 7.14: Design output and report file from PROFIS

## 8. INSTALLATION AND INSPECTION

### 8.1 Introduction

Installation is basically the practical outcome of the design and planning stages. Fig. 8.1 defines the main high-level relevant aspects to allow a good quality installation, which requires some key points to be followed.

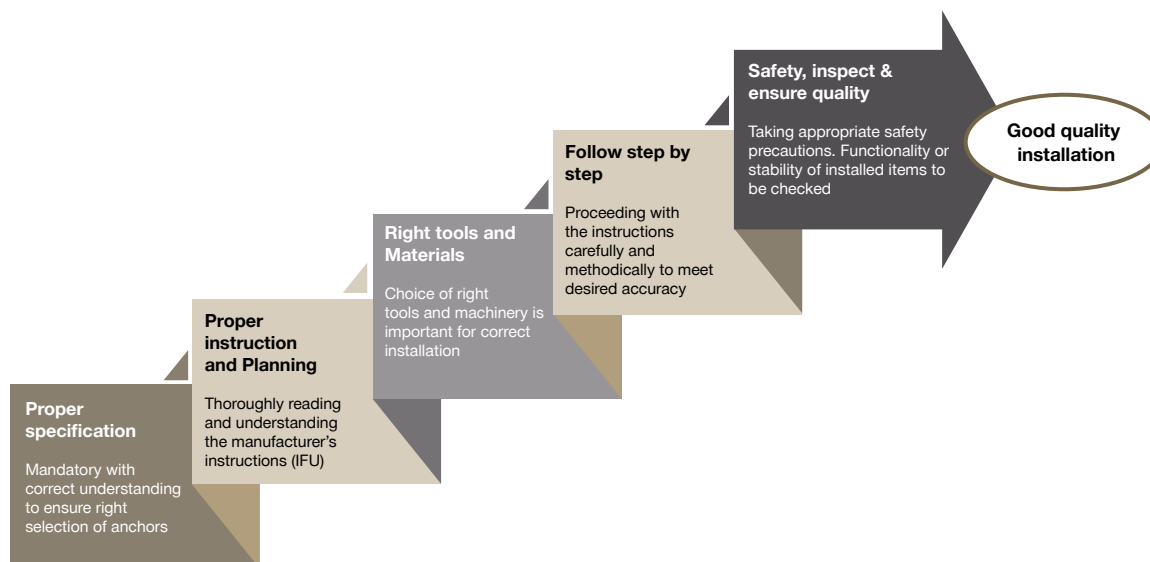

Fig. 8.1: Key points to be followed for proper installation

Specifying the right product is important. However, its performance might be jeopardized by an improper installation. A faulty attempt such as short drilling, improper cleaning, under-torquing etc. may lead to catastrophic results, despite the right anchor being specified by the structural engineer. EC2-4 [1] asks the designers to state all installation parameters together with the anchor to avoid improper installation on the jobsite. Manufacturer's instructions must be checked and followed as these documents provide product-specific installation processes and address any additional special requirements. They also help in the selection of a qualified product that is certified to meet certain standards and is suitable for any application. The detailed discussion on product assessments and qualifications can be found in [Chapter 4.2](#) and certified products from Hilti are in [Chapter 5](#).

Inspection of post-installed anchors is an essential safety measure to help ensure proper installation quality. Details on execution of inspection after installation are discussed in this chapter.

### 8.2 What does Eurocode require for a proper specification?

The way an anchor is installed, in what base material and where it is positioned can influence its performance and load-displacement behavior. Any variation from the installation procedure recommended by the manufacturer is likely to negatively influence the anchor performance. The effect of these parameters can vary depending on the anchor type and from product to product.

EC2-4 [1] states that construction drawings or supplementary design documents to be delivered by structural engineer should include:

- **Location of the anchors, including tolerances:** the coordinates of the baseplates with the edge distance.

- **Number and type of anchors:** different fastener types have different working principles which might change the anchor performance.
- **Spacing and edge distance of the fastenings, including tolerances:** every anchor has a specific edge and spacing value for cracked and uncracked concrete.
- **Thickness of the fixture and diameter of the clearance holes:** baseplate thickness is important when it comes to a rigidity check. The loads acting on the anchor might vary depending on the rigidity of the fixture. Moreover, this affects the total length of anchor required.
- **Position of the attachment on the fixture, including tolerances:** stiffeners and profiles also affect the rigidity of the fixture, so the designer should state all attached elements on the fixture in detail.
- **Maximum thickness of a grout layer between base material and concrete:** stand-off height should be specified together with the filling material information (e.g., grout or insulation layer) as it affects the bending performance of anchors.
- **Installation instructions:** ETA documents state specific installation instructions regarding drilling, cleaning, tightening etc. Following an installation method that does not comply with an ETA statement can lead to catastrophic results due to drastic performance reduction.

The in-service conditions: environment, temperature, loading type, uncracked vs. cracked concrete etc. have been discussed in detail in previous chapters.

### 8.3 What are the installation steps to be followed by the contractor?

The installation of a baseplate to connect steel to concrete elements varies with the application requirements. However, the fundamental steps do not change. In Fig. 8.2, we give an overview of the entire end-to-end workflow.

Hilti offers a comprehensive portfolio that adds value throughout the complete workflow from design to installation and beyond.

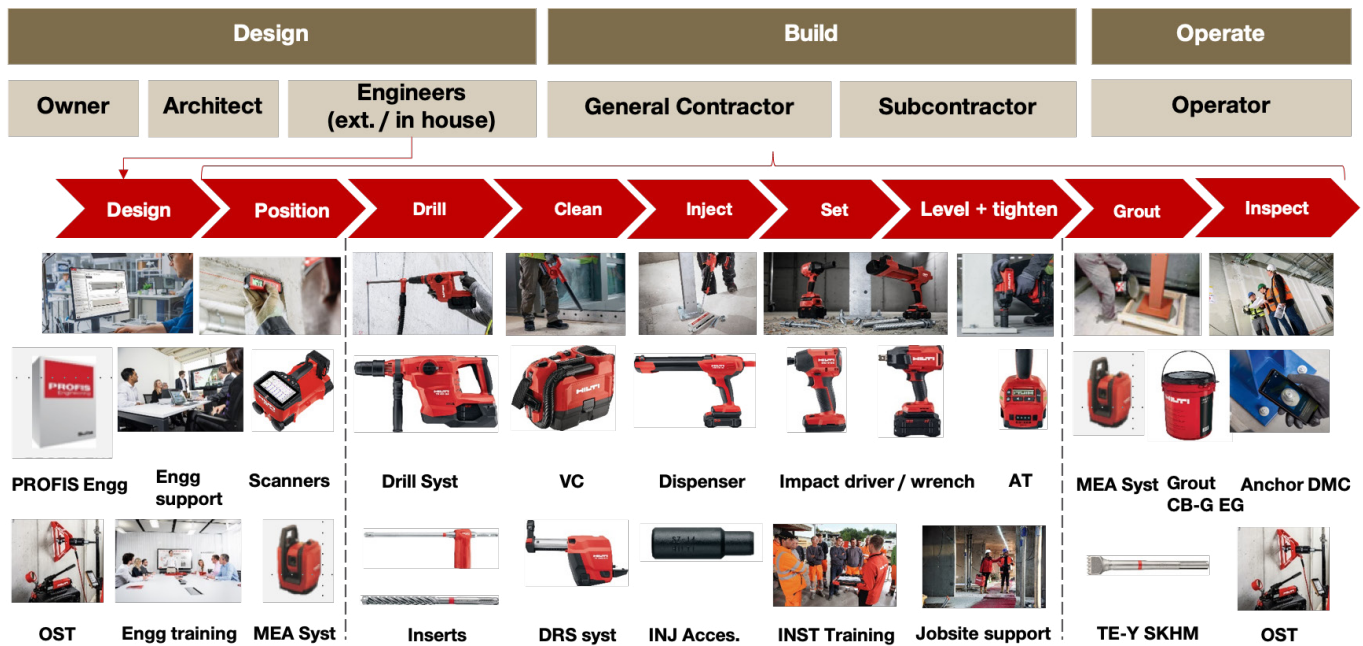

Fig. 8.2: Flowchart for installation of post-installed anchors



During design, jobsite constraints should be considered. Post-installed anchoring solutions allow maximum flexibility and jobsite efficiency. However, a too generic specification, which does not take into consideration the relevant jobsite conditions can lead to risks such as a reduction in bond strength of chemical anchors capacity when changing a drilling or cleaning method.

In following sections, we give an overview on the specific installation steps.

### 8.3.1 Positioning of baseplate/boreholes

Positioning of the exact location of a baseplate is essential and a slight misplacement can lead to significant problems for structural safety, i.e., because the assumed design loads, may not be true anymore, due to the occurrence of unplanned eccentricities. A significant deviation of the borehole from the vertical axis will influence the load transfer behavior of an anchorage ( $\pm 5^\circ$  deviation is allowed as per EAD 330232 [21]). The easiest way to position a baseplate is by using a Hilti measuring tool to mark its exact location and that of the corresponding anchors on the concrete surface. Alternative methods include the use of lasers such as Hilti rotational or multiline lasers. Vertical alignment and horizontal levelling are also important for the positioning of baseplate.

Additionally, the scanning of base material to be free of existing reinforcement, pipes, tubes, cavities, etc. and the marking of positions of boreholes for baseplate placement is required. Hilti offers a wide range of measuring tools and scanners for efficient work on the construction site. Some highlights are given in Fig. 8.3. Hilti offers also a long-range robotic total station for single-handed operation on the jobsite. It offers high accuracy in angle measurement (Fig. 8.4).



#### Laser meter

Handheld device uses laser technology to measure distances and heights accurately. Useful when to measure long distances and hard-to-reach spots. This system can measure distance up to 200 m.

#### Rotary laser

Self-levelling lasers that project a level line or a plumb beam to assist with levelling and alignment on site. These are designed to be robust and easy to use for long-distance levelling, aligning, squaring and slope.

#### Line and point

Line lasers that project horizontal and vertical lines onto surfaces, help in layout and alignment. Point lasers emit multiple laser points to mark reference points accurately and are used in levelling and plumbing.

#### Concrete scanner

Designed for precise, non-destructive structural analysis and used to detect hidden objects within concrete, such as rebar, post-tensioned cables etc. Prevents damage during drilling or cutting operations for installation of anchors.

#### Concrete monitoring systems

Help to bring accurate concrete information in real-time, consist of wireless or wired sensors embedded in concrete. This system monitors temperature, moisture and strength of concrete.

Fig. 8.3: Measuring tools and scanners for positioning of boreholes



Fig. 8.4: Use of laser at a jobsite while positioning bore holes

The location of existing reinforcement and other embedded items is generally identified with scanning methods categorized as:

- (a) Scanners that locate ferrous materials using Electro-Magnetic Induction (EMI) technology, such as Hilti's PS 300 (see Fig. 8.5 a), b). For reinforcing bars located within 200 mm from the concrete surface, ferrous scanners using EMI technology can detect rebar location and can also estimate both rebar cover and diameter.
- (b) Scanners that utilize Pulse Radar Technology (PRT) to detect both ferrous and non-ferrous embedded items like metals, post-tensioned systems, non-metals like wood, wires, etc. and cavities. A good example is Hilti PS 1000-X scanner: refer to Fig. 8.5 c) and d).



a) Scanning for ferrous objects



b) Hilti's HIT PS 300 Ferrosan



c) Scanning for ferrous and non-ferrous objects



d) Hilti's PS 1000 with tablet

Fig. 8.5: Ferrous and non-ferrous scanning equipment for structural verification and documentation

### 8.3.2 Drilling of boreholes in concrete

After positioning is done, the boreholes can be drilled into concrete. It is of major importance that a structural engineer specifies the drilling method during the design phase, as the correct hole drilling is critical for the performance of post-installed anchors (details are listed in Fig. 8.6). Detailed instructions,

referred to as “Instructions for Use” (IFU) accompany all Hilti anchoring products. In addition, drilling through existing reinforcement or other embedded objects should in general not be undertaken prior to consultation with the structural engineer or other authority having jurisdiction.

#### Precise placement

Allows precise placement of anchors in concrete. It also ensures proper alignment and accurate positions of anchors with respect to a structure.

#### Hole cleaning

Using the proper cleaning technique, a borehole can be drilled absolutely dust free. For any unplanned activity, e.g., anchors placed without drilling holes, the holes cannot be kept debris-free.

#### Compatibility

Ensures compatibility as different types of anchors require different borehole diameters and depths. When drilling boreholes, ascertain the requirement as per manufacturer's guideline.



#### Control over depth

Allows precise control over embedment depth, which is the distance between head and bottom of anchor. This has a significant impact on the performance of anchors.

#### Reduced risk of cracking

Less likely to cause cracking or damage to surrounding concrete compared to other methods. It is crucial for structural integrity and aesthetics as well.

#### Installation efficiency

Using the correct technique and equipment, installation will be relatively quick and efficient. It will speed up the construction work at jobsite.

Fig. 8.6: Importance of borehole drilling

### 8.3.2.1 Rotary-impact drills (hammer drills/ HD) equipped with standard or cruciform carbide bits)

Hilti rotary hammers are specially designed and engineered to handle the tough demands of drilling holes in hard materials like concrete. They utilize a combination of rotation and hammering actions to penetrate concrete. Rotary hammers with drill bits (TE-CX, TE-CY) or a 2-flute helix (TE-C) are readily available and are the preferred approach in most applications, depending on requirements (Fig. 8.7 a). There are certain limitations to the drilled diameter and depth for each type of rotary hammer, meaning that rotary hammers may not be the preferable solution. In some cases, rotary hammers are used for digging and tamping in narrow spaces.

### 8.3.2.2 Diamond-core drills utilizing either wet or dry coring technology (DD)

This drilling method was developed to create precise holes in concrete by utilizing a special diamond-core drill bit. The diamond core drill bit is designed with diamond-embedded segments on the bit's surface and it provides exceptional hardness and abrasive resistance, allowing the drill bit to effectively cut through concrete (Fig. 8.7 b)). For longer anchorage lengths and large diameters, core drills may be the preferred option. Core drills typically produce a very smooth hole that is usually covered with a thin film of dust that is deleterious to bonding. For qualified systems, specific hole cleaning procedures have been developed and are included in the product ETAs and in the Instruction for Use (IFU). Diamond core drilling uses either dry or wet coring technology,

**Note:** Different types of drilling machines are available. They are differentiated mainly by weight, impact energy, rotation and hammering frequency. Hilti recommends the most appropriate machine for different ranges of hole diameters to optimize productivity.



a) Drilling holes with a Rotary hammer



b) Diamond core drilling machines

Fig. 8.7: Drilling machines

### 8.3.3 Borehole cleaning

Depending on the drilling method and the anchors specified, a borehole needs to be cleaned according to the manufacturers' guidelines which can be found within the approval document or the IFU. Proper cleaning of the borehole is essential for the anchor's performance and load bearing capacity and to prevent potential failures. We can generally distinguish amongst five different cleaning methods for mechanical and chemical anchoring solutions.

- Non-cleaning
- Automatic cleaning with hollow drill bit
- Manual cleaning with blow-out pump and brush (see the product IFU for the no. of repetitions)
- Manual cleaning with compressed air and brush (see the product IFU for the no. of repetitions)
- Water cleaning, flushing and brushing for diamond-cored holes (see the product IFU for the no. of repetitions)

Some Hilti equipment designed for fastening areas and borehole cleaning is detailed in Fig. 8.8.



#### Compressed air

Used to blow out debris from the drilled hole by inserting a blow-out pump into the hole and blowing air to remove loose dust. Simple and effective method.

#### Brush

Stiff brush is used to manually scrub the inside of the drilled hole to remove loose material and dust. This is a more time-consuming process.

#### Vacuum cleaner

Vacuuming equipment is used to suck out debris from hole. It is ideal for cleaning in limited spaces and when stronger suction is required.

#### Blow out pump

For fast and efficient blowing out of dust and debris from drilled holes using high air pressure.

#### Blower gun

Compact blower for clearing jobsite debris and preparing work surfaces. This is a convenient and compact air blower for outdoor use.

#### Water management

Single unit for the supply of cooling water as well as the collection and filtration of wastewater from diamond drilling systems.

Fig. 8.8: General bore hole cleaning systems

**Note:** For cases where adherence to multi-step hole cleaning procedures may not be possible, the use of Hilti products which are qualified for no cleaning or automatic cleaning with Hilti Hollow Drill Bits (HDB) is strongly recommended.

### 8.3.4 Anchor setting (mechanical anchors)

Setting of mechanical anchors depends on type as there are different methods for setting. They are either pushed, screwed or hammered into the borehole depending on the anchor type (Fig. 8.9). For more

details regarding the installation of specific anchors the IFU may be consulted. Some of the expansion anchors may be tightened by machine torquing. After inserting the anchor in a borehole, torquing is done with a calibrated torque wrench or Adaptive Torque module system (AT).



Fig. 8.9: Installation of mechanical anchors using setting tools and impact wrenches

The **Adaptive Torque module (AT)** is a device that provides real-time feedback and control for torque applications such as the tightening of mechanical anchors. It helps to ascertain accurate and consistent torque is applied, which reduces the risk of over- or under-tightening. An easy and efficient set up helps reducing chance of mistakes. The documentation process provides better accountability and back-office efficiency. Fig. 8.10 shows an example of a Hilti AT module system for an impact torque wrench.

**Note:** Machine torquing with AT module enhances jobsite productivity and facilitates accurate execution.



Fig. 8.10: Hilti AT module system for impact torque wrench

**Note:** Hilti has different types of automatic, semi-automatic or manual impact wrenches and drivers that provide the impact energy and torque capacity required for different types and sizes of mechanical anchors.

### 8.3.5 Mortar injection (only for chemical anchors)

Basic considerations associated with the mortar injection of bonded anchors must include:

- **Is the appropriate injection equipment available, including all necessary accessories, to ensure correct dispensing and mixing?**

The **suitable dispenser** recommended by manufacturer must be used. Incorrect dispensers might cause an improper ratio between mortar and plasticizer. For example, the foil pack for HIT-HY 200 is different to other chemical adhesives in the portfolio due to a different mixing ratio of the two components. In addition, contaminated dispensers might cause mortar blowout while pulling the trigger.

- **What mechanical effort or equipment is required to inject the adhesive and install the anchor into the adhesive-filled hole?**

Especially for serial applications, such as sound barriers, easy installation is important. Installers might lose time while pulling the triggers and it is hard to inject the exact amount into all holes. This might increase the labour effort and the total cost accordingly. Therefore, Hilti recommends using **battery powered dispenser Hilti HDE 500** in combination with the Hilti volume calculation App (see Fig. 8.11 a), b) and d)) to help limit wastage and improve jobsite productivity.

The objective of adhesive injection is to achieve a void-free installation because it directly affects an anchor's performance, reliability and safety. It is important to inject **enough adhesive into the hole** by avoiding any void in it. Hilti also recommends the use of matched-tolerance piston plugs (see Fig. 8.11 c)). **Piston plugs** provide positive feedback to the operator for controlling the injection process through the pressure of the adhesive on the plug. This has been shown to dramatically improve injection quality and efficiency by eliminating air voids (see e.g., [55]).

- **Can adhesive be injected and the anchor rod installed within the curing time?**

Depending on the **installation temperature**, hybrid mineral mortars might get cured before the installer inserts the rod. Epoxy mortars are most likely preferred over hybrid ones in hot-climate countries to avoid these mistakes. On the other hand, hybrid mortars are preferred by users in cold regions to accelerate the installation process.

- **Is the adhesive suitable for the concrete moisture conditions, hole orientation and drilling method?**

An adhesive's suitability with **dry, wet, or flooded holes** is also stated in this document. **Overhead and horizontal installations** may be cumbersome, and it might result in leaking if the mortar viscosity is too low at high installation temperature. The design engineer should get in touch with the manufacturer to select the best match for this application.

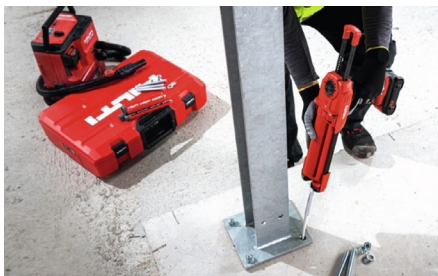

a) Adhesive mortar injection



b) Battery powered and pneumatic dispensers



c) Piston plug

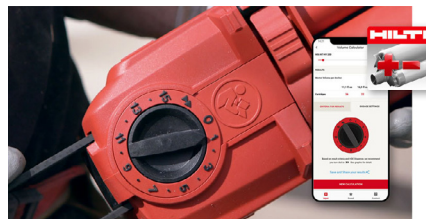

d) Volume calculator for mortar

Fig. 8.11: Injection of adhesive mortar using automatic dispenser, piston plug and volume calculator app

- **What should be considered when inserting anchor rods?**

After adhesive injection, anchor rods are supposed to be pushed into the mortar within the curing time. This is essential to centralize the rod in the borehole and surround it with chemical. Secondly, it is

important to use an ETA-approved anchor rod. There is a common tendency to replace an anchor rod with a local solution that is not compliant with the chemical adhesive. There is also a common misbelief that the anchor rod does not have any effect on the fastener's performance if the right chemical adhesive is injected. However, a **rod's geometry, steel quality and coating material have a significant impact on the performance of bonded anchors.**

**Note:** After drilling the hole diameter, it is recommended that the rod fitting is checked prior to injecting mortar.

Small diameter anchor rods can be inserted in a vertically downward direction with (relatively) small effort. However, large diameter rods in horizontal and upward-inclined orientations may require substantial effort to be inserted into the adhesive-filled holes (refer to Fig. 8.12).



a) Anchors installed in vertically downward direction



b) Drilling being done for horizontal application

Fig. 8.12: Installation of bonded anchors in different directions

- **How will an anchor rod be held in place during the curing of adhesive?**

It is important to centralize the rod in the hole to surround it with adhesive. For overhead and horizontal installations in particular, manufacturers may recommend putting wedges onto four sides of the rod during installation.

### 8.3.6 Improving jobsite practices with spec2SITE solutions

The Hilti spec2SITE offering includes differentiated and innovative solutions that enable contractors to improve the key steps of their application workflows, helping to make jobsite practices - faster, simple, safer and more sustainable.

These solutions when combined with our onsite presence and support aim to better connect the design specifications with the jobsite. In a simplified way the main steps of the applications workflow can be described as shown in Fig. 8.13.



Fig. 8.13: Application key steps

The Hilti spec2SITE offer includes the following solutions:

**SPEC2,SITE**

1. **Drill and Clean: Virtually dust-free simultaneous drilling and cleaning** with a clean and healthy drilling process using a system combining Hollow Drill Bits (HDB) and vacuum cleaners (VC) to help to ensure proper hole cleaning. This system can be used for both dry and wet concrete and eliminates the most critical step in installation process, i.e., cleaning holes after drilling and before the injection of mortar or insertion of anchors. The dust and debris produced is continuously captured into the vacuum cleaner during the entire drilling operation (see Fig. 8.14). Hilti also offers non-cleaning anchors technology which eliminates the cleaning step from the installation of these fasteners.



Fig. 8.14: Hilti system for dust-free drilling of holes with HDB, VC and non-cleaning technology anchors

## 2. Preparation:

**Chemical anchors:** using a battery powered tool HDE 500-22, paired with a mobile application for calculating the required mortar volume, the user can preset the exact amount of mortar, helping to eliminate underfilling and thus increase the installation quality and safety as well as potential overfilling of the borehole, reducing this way the wastage of mortar (see Fig. 8.15).

**Mechanical anchors:** using setting tools to set the anchors help to increase jobsite productivity and safety. This technology also helps in protecting the corrosion protection on anchors, improving the overall application aesthetics as well (Fig. 8.15). Hilti also offers hybrid screw anchors (e.g., HUS4-MAX) to avail the advantage of no-cleaning technology, eliminate waste and immediate loading.



Fig. 8.15: : Controlled injection of adhesive mortar and setting tools for mechanical anchors to limit waste

3. **Torquing using a cordless impact wrench:** torquing of anchors is important to help ensure fasteners are safely installed. Hilti SIW cordless impact wrenches offer an ultimate balance of power and handling and when combined with **Adaptive Torque Module (AT)** help to eliminate under or over-torquing. This system works by scanning the unique fastener QR code present at the package and when the right installation settings are achieved, it shows the user a green LED, confirming the installation is complete (Fig. 8.16). Additionally, for inspection or later maintenance purposes, the Hilti AT system provides the possibility for documenting the installed anchors using a specific software that connects to the AT module and extracts the application data.

**Note:** Over-torquing may cause failure during installation. Under-torquing may limit the load-carrying mechanism.





Fig. 8.16: SIW system torque wrench and AT module

In summary the Hilti spec2SITE offers the following benefits as presented in Fig. 8.17.

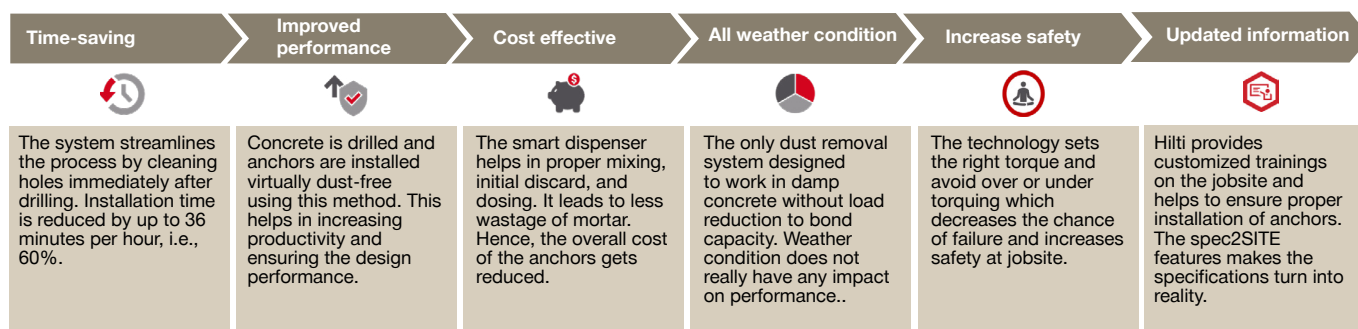

Fig. 8.17: Hilti spec2SITE features and benefits

### 8.3.7 Hilti TraceFast technology

Hilti's TraceFast technology offers a solution for the reliable identification of concrete anchors. Using a unique ID printed on every fastener, verifying design compliance is as quick as taking a photo with your smartphone. Traditionally, anchor identification and documentation meant a lot of guesswork and paperwork. Hilti can help you upgrade to a faster and more reliable alternative solution with TraceFast (Fig. 8.18).



#### Making every fastener traceable

A data matrix code (DMC) makes every fastener uniquely identifiable and therefore traceable. The DMC unveils a unique ID that contains all relevant information: instructions for use, approvals, technical data. The 25-digit ID even contains the batch and item number so the fastener can be traced back to its manufacturing origin. Simply scan the DMC on the fastener with your smartphone.



#### Identifying what is installed

In general case, it is not so easy to identify whether specified anchor has been installed. Using the Hilti ON!Track App makes it easy to identify if the right anchor is installed. It's a rapid identification process that provides an efficient way to document the installation quality and gives easy access to specific information related to quick verification of installation.



#### Standardizing documentation

Documentation of progress and other important project information is a major task. The usual process is time-consuming and requires lot of effort, manpower etc. Traceable fasteners enable the digitization of the manual documentation process, saving time and reducing complexity.



Fig. 8.18: Hilti TraceFast technology features

## 8.4 Inspection, testing and quality control

Inspection and quality control are two important elements in the installation of post-installed anchors for construction applications. They help to ensure that the project work meets its requirements and specification. The process involves assessing products, aiming to identify defects, deviations, or inconsistencies. Assessment / verification is done via laboratory tests against the performance criteria and by conducting onsite tests such as pull-out tests (Fig. 8.19). This helps in maintaining consistency, reliability and customer satisfaction by rectifying issues before the product is in service. On-site testing is possible both in unconfined and confined set up for tension loading and unconfined set up for shear loading.

**Note:** On-site testing offered by Hilti:  
1) Foundation for efficient design with test data; 2) State-of-the-art proof load test documentation.



Fig. 8.19: Onsite testing by Hilti (unconfined tension setup)

- **Proof load check:** on-site pull-out or shear testing of post-installed anchors involves applying force to assess load bearing capacity and installation quality. It helps to validate the quality of installation. Correct installation is usually achieved only when IFUs are followed by trained and skilled installers. Proper testing procedures are crucial for conforming structural safety and integrity. These tests are usually non-destructive.
- **Determining design resistance:** on-site testing can help the designer/engineer to derive design values of a post-installed anchor system when a standard design method/approval for a specific base material is not available. The load vs. displacement data generated in the test report and an evaluation of the results help to achieve efficient design while maintaining structural integrity. By performing on-site testing, engineers can be guided with a relevant design value to arrive at optimized, cost effective and code compliant design even if there is no specific design data readily available. These tests can be executed as:
  - a) destructive tests to the ultimate load or
  - b) as non-destructive tests to a predefined load

In both cases, a) and b) we have the possibility to execute and evaluate tensile load tests and/or shear load tests.

**Note:** Onsite testing should not be employed to assess bond resistances higher than the values included in an ETA for conditions covered by the same ETA (e.g., an anchor in normal concrete within the classes C20/25 and C50/60). The assessment of pull-out resistance for conditions beyond the scope of an ETA should account for influencing factors that could not be tested (e.g., elevated temperature or sustained load).

Contact Hilti for support with engineering judgements for non-standard cases of design resistances in unknown base material conditions.

**Quality control:** quality control of post-installed anchors involves various steps including visual inspection, load testing, torque verification and adherence to industry standards. Quality control is a set of procedures intended to ensure that post-installed anchors adhere to a defined set of quality criteria. It involves actively managing the construction process and implementing corrective actions when necessary. Proper documentation and maintenance of records are essential for tracking the installation process and verifying quality. An example of quality control checklist with the required activities related to an efficient and correct installation of post-installed anchors is presented in Table 8.1.

**Note:** The items mentioned in the following checklist are not exhaustive and not project-specific, hence it is the responsibility of the project team to amend it as necessary before using it.

Table 8.1: Checklist of important measurements / processes of installation

<b>ANCHOR CHECKLIST</b>			
<b>Application Information</b>			
Anchor family		Specification of anchor / chemical and anchor rod (Hilti or equivalent)	
Dia of anchor		Drill hole diameter and depth	
<b>Method / Process</b>		<b>Check box</b>	<b>Values / Remarks</b>
<b>Drawing, specification and preliminary check</b>			
Drawing status and latest revision		<input type="checkbox"/>	
Design specification and general notes		<input type="checkbox"/>	
<b>Pre-installation check</b>			
Scanning of base material for existing rebar/other objects		<input type="checkbox"/>	
<b>Installation Method check</b>			
Selection of drilling method, correct drill bit, tools		<input type="checkbox"/>	
Hole roughening / cleaning according to IFU		<input type="checkbox"/>	
<b>Adhesive mortar check</b>			
Approved adhesive mortar used		<input type="checkbox"/>	
Right tools and accessories for adhesive mortar dispensing		<input type="checkbox"/>	
Curing time of mortar		<input type="checkbox"/>	
<b>Torquing of anchors</b>			
Use of right installation tool		<input type="checkbox"/>	
Right value of torque applied		<input type="checkbox"/>	
Screwing / insertion of anchors and levelling and tightening		<input type="checkbox"/>	
<b>Hilti System for smart injection of mortar</b>			
Temperature and surface condition before injection		<input type="checkbox"/>	
Right volume of adhesive (Hilti Volume Calculator App)		<input type="checkbox"/>	
Right accessories for adhesive mortar dispensing		<input type="checkbox"/>	
<b>General checking for all anchors (safety checks and measurements)</b>			
Correct levelling and positioning		<input type="checkbox"/>	
Anchor rod free from rust, mortar, grease, oil, dirt, etc.		<input type="checkbox"/>	
Onsite pull-out testing conducted		<input type="checkbox"/>	
Any other checks, photos, documents, records as per scope		<input type="checkbox"/>	

## 8.5 Construction specifications

Construction specifications are detailed written documents that outline the materials, methods, and quality standards required for a construction project. They provide guidelines / instructions to construction teams about how to execute the job, ensuring consistency, accuracy and compliance with design intent. Specifications cover various aspects including the qualified products to be used, installation processes, testing requirements etc. In the context of post-installed S2C connections, they cover the following aspects:

- Post-installed anchor details, along with diameter, installation depth and qualification information, see [Chapter 4](#)
- Design input details: loading type, load values, design working life, application details and the design methods, e.g., EC2-4 [1] / EOTA TR 082 [46] / EOTA TR 061 [24], etc.
- Requirement of pre-installation works: scanning of concrete, drilling techniques etc., see [Section 8.3](#)
- Description of installation requirements (tools, accessories such as piston plugs, extension hoses, torque wrenches etc.), see [Section 8.3](#)
- Additional requirements (e.g., onsite testing if required), see [Section 8.4](#)

A sample construction specification drawing for post-installed anchors is shown in Fig. 8.20.

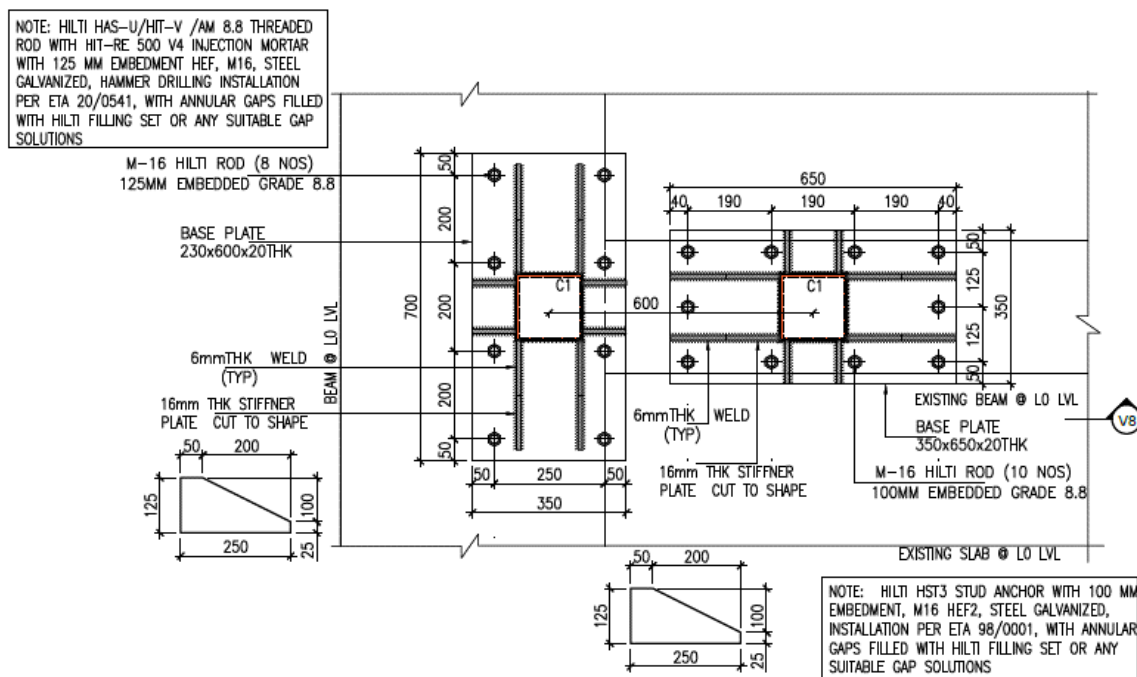

Fig. 8.20: Reference specification for post-installed anchor solution

## 8.6 Hilti for engineering support

**Engineering judgement** refers to the informed decision-making process that engineers use based on knowledge, experience and expertise. It involves evaluating different options, considering trade-offs and making choices that best align with the project requirement, safety, feasibility and ethical considerations. Engineering judgement is essential for solving complex problems, designing systems and ensuring the quality and reliability of a project. Hilti offers the following support to designers, which can help them to run a project smoothly where sound engineering judgement is required.

## Ask Hilti

Ask Hilti is an online engineering community designed to build support and collaboratively offer curated expert advice to engineers and architects. Ask Hilti is free and open to everyone. Registered users can post questions and participate in technical discussions. It also extends ON-DEMAND webinars for continuing education credits and expert advice from top engineering professionals.



## Hilti Backoffice

Hilti offers support in designing solutions for complex and non-typical problems and situations. For any kind of engineering support, you may reach out to Hilti where extensive support is provided online or offline. Special technical expertise on technical topics can also be supported by Hilti.



## Hilti Assets

Hilti assets are the backbone of Hilti. Hilti has a collection of technical publications including whitepapers, handbooks, e-learnings, training materials, design software, academy papers etc. on relevant subject matters of interest for the engineering/design community. Hilti is highly focused on the continuous dissemination of the latest technology and practices all over the world.



## 9. REFERENCE PROJECTS

### 9.1 Bridge 231, Brno, Czech Republic

Bridge 231 is a bridge on the key Czech highway D1, going over a major railway line near the city of Brno. This project was completed in 2023.

#### Problem statement and objective

Concrete bridges are typically designed with a lifespan of 100 years. However, this bridge's edge is particularly vulnerable due to its exposure to environmental elements such as de-icing chemicals, salts, rain and freezing conditions. Additionally, certain sub-structures attached to the bridge's edge, like crash and sound barriers, have a considerably shorter lifespan of approximately 20-30 years.

To address this vulnerability, the edge of the bridge is constructed as a separate concrete element called **edge beam** (Fig. 9.1 a) and b)). A waterproofing layer is essential between the bridge deck and the edge beam. Notably, these two concrete components must be structurally interconnected through this waterproof layer. This configuration results in a unique design scenario: the connection between the two concrete pieces consists of a post-installed fixing at the base in the bridge deck and an upper part attached to a steel cantilever in the edge beam or acting alone as a headed anchor using a nut at the top. The fixing ensures that it penetrates the waterproof layer without compromising its watertightness by using a special plastic disc and overflow of epoxy mortar.



a) Steel cantilevers fixed by Hilti rods and RE 500V4



c) Rod with HIW-SD sealing cap for waterproofing



b) Anchors in rebar before pouring concrete

Fig. 9.1 Hilti Solution / products in bridge 231, Czech Republic

#### Approach followed (design and solution)

The conventional solution for bridges typically involved the use of rebar, which posed challenges in waterproofing. Hilti introduced an innovative approach named "Hilti Plinth Anchoring" (henceforth referred to as HPA). Hilti customized this method to suit the customer needs, subsequently developing a local guideline to design HPA using the existing modules in PROFIS Engineering. The HPA is composed

of a threaded rod, available in either carbon steel with Hot Dip Galvanizing (HDG) or A4 stainless steel. It involves the use of the chemical mortar HIT-RE 500 V4. To ensure optimal overflow and watertightness, a plastic sealing disc called HIW-SD is utilized (as depicted in Fig. 9.1 c)).

The effectiveness of the watertight seal formed by the cured HIT-RE 500 V4 beneath the HIW-SD sealing ensured the water-resistant layer was validated through tests conducted at the Austrian Highway Institute. While the traditional design of concrete-to-concrete connections typically employs rebar in accordance with EC2-1-1's [27] rebar theory, our specific requirement to secure the HIW-SD plastic sealing disc led us to opt for threaded rods and thus follow anchor theory according to EC2-4 [1]. Tests conducted by Hilti have confirmed that the water-resistant layer induces lever-arm and consequent moment loading, which is of negligible magnitude.

Given this requirement, we treat the design of the bottom and top sections as two distinct scenarios: the bottom segment involves a post-installed chemical anchor, adhering to the EC2-4 [1] design done in PROFIS Engineering. The top segment is approached as a pre-cast headed anchor, also done by EC2-4 [1] in PROFIS Engineering. It's worth noting that in our application, this setup is inversely aligned compared to conventional baseplates.

### Design methods used

**Post anchoring in bridge deck** – Design according to EC2-4 [1].

**Proof of watertightness** – **RVS 15.04.12** Austrian test method for watertightness under loading. Diameters M12-M24 certified.

**Precast part in edge beam** – Design according to EC2-4 [1] with nut at the top of threaded rod acting as precast headed anchor.

### Total solution and benefits

**Software:** PROFIS Engineering software was used for design calculation.

**Hardware:** the Hilti RE 500 V4 combined with the hollow drill bits, streamlined the installation process. The battery-powered dispenser, HDE 500, further optimized the process by ensuring precise mortar dosing.

**Services:** Hilti has been engaged with government regulators to facilitate the acceptance of German and Austrian documentation at the local level. Additionally, Hilti has crafted its own comprehensive document that describes the entire design approach (refer to [Chapter 7](#)). This serves both as a blueprint for future projects and to gain acceptance for the HPA within the Czech engineering community, underscoring its efficacy, compliance and safety in fixing edge beams.

**Training:** Hilti provided training for the installers and offered consultation to supervisors regarding the quality of the installation.

## 9.2 The Prestige Mahalakshmi project in Mumbai, India

The Prestige Mumbai project comprises four towers out of which two towers are going to be 250 m and 300 m tall, which makes Tower C to be the India's tallest commercial tower (Fig. 9.2 a)). The rooftop level at Tower C edifice will also serve as Prestige Group's regional headquarter. This is a first-class residential project which offers all necessities with modern amenities and wellness features.

### Problem statement and objective

The project is unique in terms of the eccentric core design for tower C as the placement of columns (2.4 m x 2.4 m) is between a span of 10 m and 39.5 m which potentially results in high base shear. This resulted in requirement of very dense reinforcement detailing that limits drilling depth for all post-installed anchors. Another requirement by the designers was that all post-installed fastening systems must be designed for seismic actions. Furthermore, at the job site some cast-in anchors got misplaced and designer went for post-installed chemical anchor solution. For a hanging steel column assembly to support loft on each slab of the Tower D (160 m tall) the scope was given for through bolting anchors to support the built loft around corners and mid-edges. Also, to support lift guide rails, another through bolting application was specified. Finally, project demanded third party approved post-installed solutions (e.g., see (Fig. 9.2 b)).



a) Prestige Mahalakshmi project overview



b) Post-anchoring application for baseplate connection

Fig. 9.2: Prestige Mahalakshmi project in Mumbai

### Approach followed (design and solution)

From the very first stage, digital design and engineering was a part of the process towards achieving the best effective post-installed solution. PROFIS Engineering software was used by designers to achieve suitable and optimized solution for all post-installed connections (Fig. 9.3 a)). Hilti sales and engineering team collaboratively ran in depth seminars at consultant, client and contractor's office on-site (Fig. 9.3 b)).

Regular consultation with appointed field structural engineers, project coordinators and client reassured the project team of Hilti engineering driven approach as opposed to just being an anchor manufacturer. Along with PROFIS Engineering, the Hilti back office (Engineering Competence Center) was also leveraged to design critical instances.



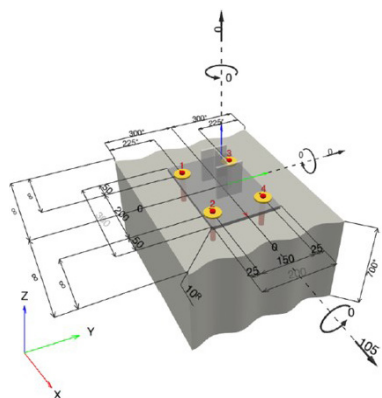

a) Sketch of baseplate and anchors in PROFIS

b) Conducting a PROFIS Workshop at designer's office

Fig. 9.3: Specification approved in the project

### Design methods used

**Post-installed anchors** – Flexible baseplate for all steel to concrete connections according to EC2-4 [1].

### Total solution and benefits:

**Software:** PROFIS Engineering with CBFEM (see [Section 7.3.5](#)).

**Hardware:** Post-installed mechanical anchors-Hilti HST3 of size M20 with embedment depth of 170 mm and HSL4 of size M20 with embedment depth of 170 mm. Post-installed chemical anchors-Hilti HIT-RE 500 V4 with HIT V 5.8 M16x150 rods were used as replacement for misplaced cast-in anchors. Through bolting application was done with AM rods of class 8.8.

**Training:** Hilti conducted a series of hands-on workshops with the site team, consultant, and client.

### 9.3 UOB Renovation project, Thailand

United Overseas Bank in Thailand is undergoing renovation of old structure of 30 years old. The building has 20 stories and strengthening work has been completed.

#### Problem statement and objective

The baseplate application was required at beam-column joints for connection (see Fig. 9.4). Some connections were subjected to very high shear load and, in some cases, tension was the dominating action. Designer wanted post-installed anchor systems with appropriate approval against fire loading. In addition to that, there was limitation in embedment depth and for this reason, chemical anchors were not used. Due to site constraints, careful cleaning of holes could not be ensured and there was a possibility of human error in drilling depth of holes. Inspection of mechanical anchors was easier as it could be verified by checking the torque values. Hence, post-installed mechanical anchors were chosen by the designer and used in this project.



a) Hilti team with customer at UOB job site



b) The steel frames are connected by anchors to the reinforced concrete structure



c) Detail of steel to concrete connection

Fig. 9.4: UOB renovation project

#### Approach followed (design and solution)

Hilti got involved in the discussion with major stakeholders of the project; owner, contractor as well as the designer to support with suitable solutions for post-installed anchor connections. Hilti visited the specifier multiple times after getting requirement details for faster specification process. The specification was submitted within a short time using PROFIS and finally it was approved by the designer (see Fig. 9.5 a) and Fig. 9.5 c)). Demonstration and installation training were conducted at site with special focus on application for mechanical anchors (see Fig. 9.5 d)). Demand of the designer was fulfilled with appropriate installation system and code-compliant approved product to cater high shear load within the boundary conditions.

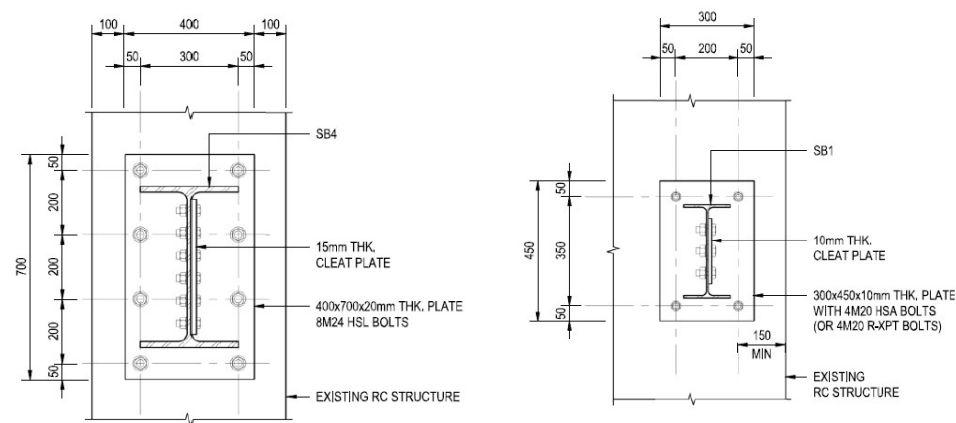

a) Specification for high shear load

b) Specification for low shear load

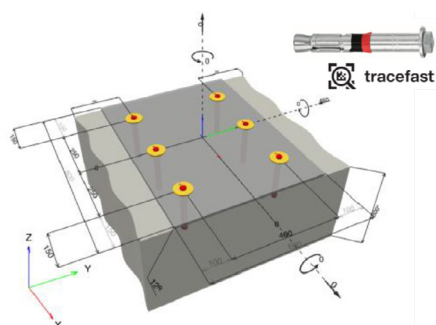

c) PROFIS design of anchors and Tracefast proposal



d) Demonstration at job-site

Fig. 9.5: Specification approved in the project

### Design methods used

**Post-installed anchors between column baseplate and concrete** – Design was done complying to ACI 318-19 [56] and Engineering Institute of Thailand Standard (EIT011008-21 [57]).

### Total solution and benefits:

**Software:** PROFIS Engineering software was used.

**Hardware:** Post-installed mechanical anchors-Hilti HSL4 of diameter M20 to M24 and Hilti HSA of diameter M16 to M20 were used.

**Installation:** AT module technology was used for a safer and more productive installation.

**Services:** Hilti has end to end collaboration with entire project team to address their queries, demand which helped the project successfully completed. Hilti has demonstrated the application at jobsite in front of all the project stakeholders.

**Training:** Hilti provided training for the installers and offered consultation to supervisors regarding the quality of the installation.

## 9.4 MAHSR Track works package, Gujarat, India

Mumbai–Ahmedabad High Speed Rail (MAHSR) Corridor is an under-construction high-speed rail line, which will connect India's economic and financial hub with the largest city of the state of Gujarat, Ahmedabad, in the western part of India (see Fig. 9.6 a)). This high-speed train will operate at speed greater than 300 kmph and cover 500 km including 12 stations.

### Problem statement and objective

With one of its kind of longest span in this greenfield project, customer wanted to ensure that minimum cost is occurred in maximum execution of RC track bed shuttering works in the span of 150 km. The requirement was for speedy installation of shutter moulds (23000 nos). The moulds were installed all over the length which worked as foundation of main track of high-speed bullet trainline. Post-installed anchor with re-usability property was the requirement for this application. Customer demanded for solution from some internationally reputed manufacturer with approved and certified products. The efficiency and cost optimization were other parameters based on which post-installed anchors were chosen.



a) MAHSR viaduct portion



b) Hilti anchor with re-usable gauge

Fig. 9.6: MAHSR project overview and anchors used for required application

### Approach followed (design and solution)

Project Manager looked for a solution which can help to reduce overall anchor cost of 23000 RC beds improving the productivity in comparison to conventional methods (see Fig. 9.7 b)). At jobsite it was not easy to install the anchors due to limited depth of drilling considering existing post tensioned strands. There was constraint in power supply due to the greenfield project with limited resources and it was addressed by Hilti with proposal of Nuron tools of one cordless battery platform (see Fig. 9.7 a)). Hilti not only supported during the initial phases and training was conducted to the client team but also carried a

series of demonstration with end-to-end solution at the jobsite. Demonstration and installation training were conducted at site with re-usability gauge of Hilti HUS4-H anchor (50 times reusability achieved in higher concrete grade, see Fig. 9.6 b)) using Hilti drilling bit and tool. Besides the anchor application, finishing of concrete was done by using light duty Hilti TE 500X accessories and inserts. The strong collaboration with the entire team helped to achieve the success with safe and more efficient installation of anchors at job site based on approved methodology on time.



a) Baseplate / Shutter frame fixing application during construction



b) Final concrete bed preparation

Fig. 9.7: Installation of post-installed anchors and final concreting

#### Design methods used

**Post-installed anchors** – Design was prepared according to Z-21.8-2137 [38].

#### Total solution and benefits:

**Software:** PROFIS Engineering software was used for all design calculations.

**Hardware:** Post-installed mechanical anchors- Hilti HUS4-H M8X65 were used. Drilling was done with TE-30 + TE CX M8 and SIW 4 Nuron tool was used for tightening and reusing anchors up to 50 times.

**Services:** On-site testing was conducted at jobsite in front of all the project stakeholders.

**Training:** Hilti provided training for the installers and offered consultation to supervisors regarding the quality of the installation.

## 9.5 Kai Tak Sport Park, Hong Kong

The Kai Tak Sports Park (KTSP) in Hong Kong is a world-class sports infrastructure that replaces the former Kai Tak Airport, featuring a 50,000-seat main stadium with a retractable roof, a 10,000-seat indoor arena, a 5,000-seat public sports ground, and a variety of community facilities.

### Problem statement and objective

The balustrade was one of key applications in steel and metal area (see Fig. 9.8 a)). As balustrade is commonly installed close to the edge of concrete, edge distance is one of the critical factors affecting anchor selection and performance. Chemical anchor was the solution that is least affected by edge distance, but not a preferred anchor proposal for steel and metal connections. Other than technical considerations, there are also safety concern relating to balustrade. Most balustrade design requires an aesthetic finish. The stud or thread rod exposed at anchor points are dangerous as citizens may step on it accidentally. Hence, the requirement was given for a mechanical anchor solution with countersunk head (see Fig. 9.8 b), c) and d)).



a) The structure at job site



a) Baseplate application during construction

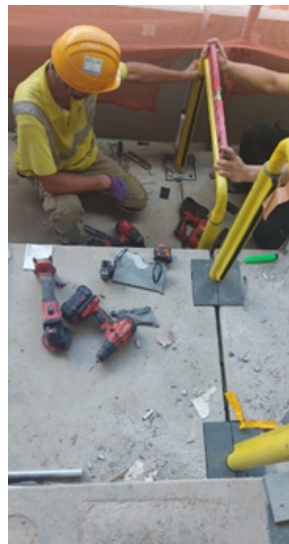

b) Ongoing installation of baseplate



c) Placement of steel profile

Fig. 9.8: Balustrade and details of the connection

### Approach followed (design and solution)

Hilti mechanical anchor HST3 was initially proposed, but the edge distance was not sufficient to cater the loading requirement after calculating with PROFIS Engineering. Hilti anchor channel HSC-I was a

possible solution for the application. However, it was not a feasible one due to planning upfront required for a cast-in solution. In view of the narrow edge condition and requirement on aesthetic finish, Hilti screw anchor HUS4 with countersunk head was the most suitable solution for this application. Due to the smaller edge requirement this solution satisfied the design limitation and countersunk head fulfilled customers' concern on safety. Hilti HUS4 in terms of price range also matches customers' expectation.

The strong connection between Hilti and customers, helped especially in catering customers' needs on anchor selection and calculation. The combination of technical and sales knowledge was the key factor contributing to the success of securing this application.

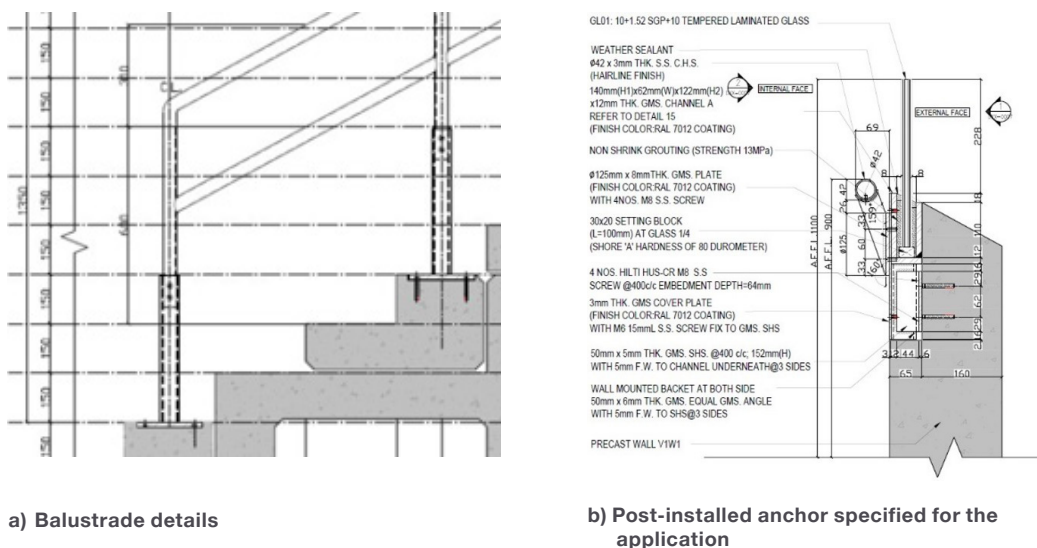

Fig. 9.9: Specification approved for this project

## Design methods used

**Post-installed anchors** – design calculation according to ETAG 001 [18] Annex C.

## Total solution and benefits:

**Software:** PROFIS Engineering software was used for design of anchors.

**Hardware:** Hilti screw anchor HUS4, countersunk feature provided aesthetic finish to fulfill the requirement.

**Services:** Hilti had continuous end to end collaboration with entire project team to address their queries, which helped the project successfully completed.

## AUTHORS

### Agamoni Das



Agamoni Das obtained her Master's degree in Structural retrofit and repair engineering from Jadavpur University (India). Her thesis was on advantages of Base Isolation as anti-earthquake design for disaster mitigation. She is also pursuing a PhD in earthquake engineering and is author or co-author of journal publications on this topic. She was engaged in solution design, especially for seismic isolation and damping devices for several bridge and building structures. She is currently a Technical Manager for Engineering Content at Hilti. Her field of interest includes seismic retrofitting, steel to concrete fastening technology.

### Giovacchino Genesisio



Giovacchino Genesisio graduated in structural engineering at the University of Florence (Italy) and obtained his PhD at the University of Stuttgart (Germany) on seismic assessment and retrofitting of reinforced concrete structures. He worked as a consultant for 5 years dealing with qualification, design, training and quality inspection of fastening systems. He is currently Group Manager for Engineering Content at Hilti. His field of interest includes concrete-to-concrete connections, seismic retrofitting and fastening technology. He is author or co-author of several scientific publications on these topics.

## ACKNOWLEDGEMENT

The authors acknowledge the contribution of the following people in the Hilti world in creating this handbook for steel-to-concrete connections. The below included list is and cannot be complete, because several people have contributed in various ways:

### Content

Pratyansh Achariya, Marien Adema, Kaushal Agarwal, Sumit Aryan, Giorgio Barone, Daniele Casucci, Jessica Dierker, Arne Echterbruch, Mariia Gavrilina, Robbi Gian-Fadri, Philipp Grosser, Aleksandr Gubskii, Priyanka Kothari, Vivek Krishnan, Jakob Kunz, Shounak Mitra, Xavi Moix-Vallribera, Ralf Neuerburg, Kresimir Ninsevic, Roberto Piccinin, Jens Pofahl, Chiara Ridolfo, Daphne Rocha, Sergio-Miguel Saraiva-Rodrigues, Kumaraguru, S, Deepesh Seth, Abu Shibily, Kushal Shroff, Amol Singh, Lars Taenzer, Fritz Wall, Georg Welz.

### Reference Projects & Pictures

Amir Adil, Milind Bhavsar, Raymond Chong, Adam Hrbacek, Worapong Kerdnikom, Fean Lee, Nikoonj Panchal, Julian Rebelo, Chanodom Ruttanachotmetha, Gosavi Sammed, Divyansh Sharma, Soni Sourabh.



## REFERENCES

- [1] EN 1992-4-Eurocode 2 - Design of concrete structures - Part 4: Design of fastenings for use in concrete, Brussels: CEN, 2018.
- [2] R. Eligehausen, M. R and F. J. Silva, *Anchorage in Concrete Construction*, Berlin: Ernst & Sohn GmbH & Co. KG., 2006.
- [3] R. A. Cook, J. Kunz, W. Fuchs and R. C. Konz, "Behavior and Design of Single Adhesive Anchors under Tensile load in Uncracked Concrete," *ACI Structural Journal*, vol. 95, no. 1, pp. 9-26, January-February, 1998.
- [4] M. S. Hoehler, *Behavior and Testing of Fastenings to Concrete for use in Seismic Applications*. PhD Thesis, California, August, 2006.
- [5] G. Faraone, T. Hutchinson, R. Piccinin and J. Silva, "Anchor Performance in Cyclically Loaded Shear Walls," *ACI Structural Journal*, vol. 119, no. 6, pp. 35-51, 2022.
- [6] D. A. Watkins, T. C. Hutchinson and M. S. Hoehler, "Cyclic Crack and Inertial Loading System for Investigating Anchor Seismic Behavior," *ACI Structural Journal*, pp. 457-466, July-August, 2012.
- [7] R. L. Wood and T. C. Hutchinson, "Crack Protocols for Anchored Components and Systems," *ACI Structural Journal*, vol. 110, pp. 391-401, May-June, 2013.
- [8] T. Guillet, "Behavior of Metal Anchors under Combined Tension and Shear Cycling Loads," *ACI Structural Journal*, vol. 108, no. 3, pp. 315-323, May-June, 2011.
- [9] D. L. Thilo Fröhlich, T. Fröhlich and D. Lotze, "Fatigue of fastenings-investigations on the effect of static load level," *Otto-Graf-Journal*, vol. 18, 2019.
- [10] K. Block, F. Dreier and D. Bigalke, "Fatigue Bearing Capacity of Anchors exposed to Shear Loading," *Beton- und Stahlbetonbau*, vol. 102, no. S1, pp. 38-45, 2007.
- [11] J. Kunz, "Chemical Fastenings for Fatigue Loads," in *Joining Techniques in the Building Construction Industry*, Munich, 2023.
- [12] M. Tóth, J. Ožbolt, F. Werner and J. Hofmann, "Fatigue Behaviour of Fasteners in case of Concrete Failure: Numerical and Experimental Investigations," in *fib Symposium on Performance-based Approaches for Concrete Structures*, 2016.
- [13] ISO 834-1: Fire-resistance tests — Elements of building construction — Part 1: General requirements, Switzerland: ISO/TC 92/SC 2, 1999.
- [14] M. Reick, *Brandverhalten von Befestigungen mit großem Randabstand in Beton bei zentrischen Zugbeanspruchung (Fire behavior of fixings remote from an edge in concrete under axial tension)*. PhD Thesis, Universität Stuttgart, 2002.
- [15] M. Robson, O. Al-Mansouri, N. Pinoteau, D. Hoxha, M. Abate, K. McBride, R. Piccinin and S. Rémond, "Experimental Investigation of the Concrete Cone Failure of Bonded Anchors at Room and High Temperature," *Applied Sciences*, 2022.

- [16] R. Mege, N. Pinateau, T. Guillet, K. McBride, O. Al-Mansouri, R. Piccinin and S. Rémond, "Numerical Investigation of Parameters Influencing Fire Evaluation Tests of Chemically Bonded Anchors in Uncracked Concrete," *Engineering Structures*, vol. 209, April, 2020.
- [17] K. Bergmeister and A. Rieder, "Behaviour of Post-installed anchors in case of fire," Institute of Structural Engineering, Vienna.
- [18] ETAG 001: GUIDELINE FOR EUROPEAN TECHNICAL APPROVAL OF METAL ANCHORS FOR USE IN CONCRETE, Brussels: EOTA, 2013.
- [19] EOTA TR 029: Design of bonded anchors, Brussels: EOTA, September, 2010.
- [20] EN 1993-1-8 Eurocode 3 - Design of Steel structures-Part 1-8: Design of joints, Brussels: CEN, 2005.
- [21] EOTA EAD 330232-01-0601: Mechanical fasteners for use in concrete, Brussels: EOTA, 2021.
- [22] EOTA EAD 330499-02-0601: Bonded fasteners and bonded expansion anchors for use in concrete, Brussels: EOTA, 2024.
- [23] EOTA EAD 332795-01-0601: Bonded screw fasteners for use in concrete, Brussels: EOTA, (in preparation).
- [24] EOTA TR 061: Design method for fasteners in concrete under fatigue cyclic loading, Brussels: EOTA, February, 2024.
- [25] EOTA EAD 330250-00-0601: Post installed fasteners in concrete under fatigue cyclic loading, Brussels: EOTA, 2018.
- [26] EN 206:2013+A1:2016: Concrete - Specification, performance, production and conformity, Brussels: CEN, 2013.
- [27] EN 1992-1-1:2004-12: Eurocode 2 - Design of concrete structures - Part 1-1: General rules and rules for buildings, Brussels: CEN, 2004.
- [28] Corrosion Handbook, Hilti Corporation, 2021.
- [29] Fastening Technology Manual; Version 2023, Hilti Corporation, 2023.
- [30] fib bulletin 58: Design of anchorages in concrete, Lausanne: IFSC, 2011.
- [31] P. Grosser, Load-bearing behavior and design of anchorages subjected to shear and torsion loading in uncracked concrete. PhD Thesis, Universität Stuttgart, 2012.
- [32] K. McBride, Steel strength of anchor bolts in stand-off base plate connections. PhD Thesis, University of Florida, Gainesville, FL, USA, 2004.
- [33] K. McBride, D. Rocha and R. Figoli, Hilti Method for Anchor design in Grouted Stand-off connections, Hilti Corporation, July, 2023.
- [34] K. McBride, D. Rocha and R. Figoli, Hilti Method for Anchor design in UngROUTED Stand-off connections, Hilti Corporation, July, 2023.

- [35] EOTA TR 075: Design of bonded screw fasteners for use in concrete, Brussels: EOTA (in preparation).
- [36] ETA-21/0878: HST4-R Torque-controlled expansion anchor, made of stainless steel for use in concrete: sizes M8, M10, M12, M16 and M20, Marne-la-Vallée: CSTB, 31.10.2024.
- [37] ETA-20/0867: Hilti screw anchor HUS4, Mechanical fastener for use in concrete, Berlin: DIBt, 14.04.2022.
- [38] z-21.8-2137: Hilti HUS4 concrete screw for temporary fastenings in concrete, Germany: General construction technique permit, 21st December, 2023.
- [39] ETA-18/1160: HUS4 Bonded screw, Bonded screw fastener for use in concrete, Berlin: DIBt, 16th January, 2025.
- [40] Eurocode 8: Design of structures for earthquake resistance -Part 1 : General rules, seismic actions and rules for buildings, Brussels: CEN, 2004.
- [41] ETA-19/0601: Bonded fastener and bonded expansion fasteners for use in concrete, Berlin: DIBt, 29.01.2024.
- [42] Eurocode 2: Design of concrete structures - Part 1-2: General rules - Structural fire design, Brussels: CEN, 2004.
- [43] EN 13501-2: Fire Classification of Construction Products and Building Elements - Part 2: Classification Using Data From Fire Resistance Tests, Excluding Ventilation, DIN, 2016.
- [44] Zusätzliche Technische Vertragsbedingungen und Richtlinien für Ingenieurbauten (ZTV-ING) / Additional technical contractual conditions and guidelines for civil engineering works; Fire Curve in Part 7, Germany: BASt, December, 2023.
- [45] Eisenbahnspezifische Liste Technischer Baubestimmungen/ Railway-specific list of technical building regulations, Germany: EBA, 2016.
- [46] EOTA TR 082: Design of bonded fasteners in concrete under fire conditions, Brussels: EOTA, April, 2024.
- [47] ETA-20/0541: Bonded fastener with threaded rods, rebar, internally threaded sleeve HIS-(R)N and Hilti Tension anchor HZA(-R) for use in concrete for a working life of 50 and 100 years, Marne-la-Vallée: CSTB, 09.06.2023.
- [48] EN 1990:2002+A1: Basis of structural design, Brussels: CEN, 2005.
- [49] M. A. Miner, "Cumulative Damage in Fatigue," *Journal of Applied Mechanics*, vol. 13, no. 2, pp. 159-164, 1945.
- [50] ETA-23/0277: Post-installed fasteners in concrete under fatigue cyclic loading; Hilti injection system HIT-HY 200-A V3, HIT-HY 200-R V3, HIT RE 500 V4 and mortar capsule HVU2 with HAS-U, Berlin: CSTB, 08.02.2024.

- [51] CEN/TR 17079: Design of fastenings for use in concrete- Redundant non-structural systems, Brussels: CEN, September, 2018.
- [52] F. Wald, M. Kuříková, M. Vild, L. Šabatka, J. Kabeláč and D. Kojala, Connection design by Component Based Finite Element Method, Prague: Czech Technical University in Prague.
- [53] M. Fitz and J. Appl, "Wirklichkeitsnahe und vollständige Bemessung von Ankerplatten einschließlich der Befestigungsmittel - neue Bemessungssoftware auf Basis wirklichkeitsbaher Annahmen (Design of fixtures and its anchorages based on realistic assumptions) (in German)," *Beton und Stahlbetonbau*, vol. 87, no. 12, pp. 1179-1186, 2018.
- [54] B. P. Girme, S. P. Patil and P. D. Sathe, "Anchor Forces Under CBFEM And Rigid Base Plate Assumption Methods," *International Journal of Scientific and Technology*, vol. 08, no. 09, September, 2019.
- [55] J. F. Silva, "Overhead Installation of Injection-Type Adhesive Anchors - An evaluation of two available methods and recommendations for ACI's installer," *Concrete International*, vol. 38, no. 7, pp. 40-49, July, 2016.
- [56] ACI 318-19: Building Code Requirements for Structural Concrete, Farmington Hills: ACI, 2019.
- [57] Building Code Requirements for Reinforced Concrete Building by strength Method, Bangkok: Engineering Institute of Thailand, 2021.
- [58] A. Rieder and K. Bergmeister, "Simulated and tested seismic response of post-installed metal anchors in concrete," in *Proceedings of 3rd fib International Congress*, Washington DC, USA, 2010.
- [59] EN 14889-1: Fibres for concrete - Part 1: Steel fibres - Definitions, specifications and conformity, Brussels: EOTA, 2006.



Hilti Aktiengesellschaft  
9494 Schaan, Liechtenstein  
P +423-234 2965

[www.facebook.com/hiltigroup](https://www.facebook.com/hiltigroup)  
[www.hilti.group](https://www.hilti.group)